

# Historerex Spare Parts Illustrated Catalogue

2nd Edition.

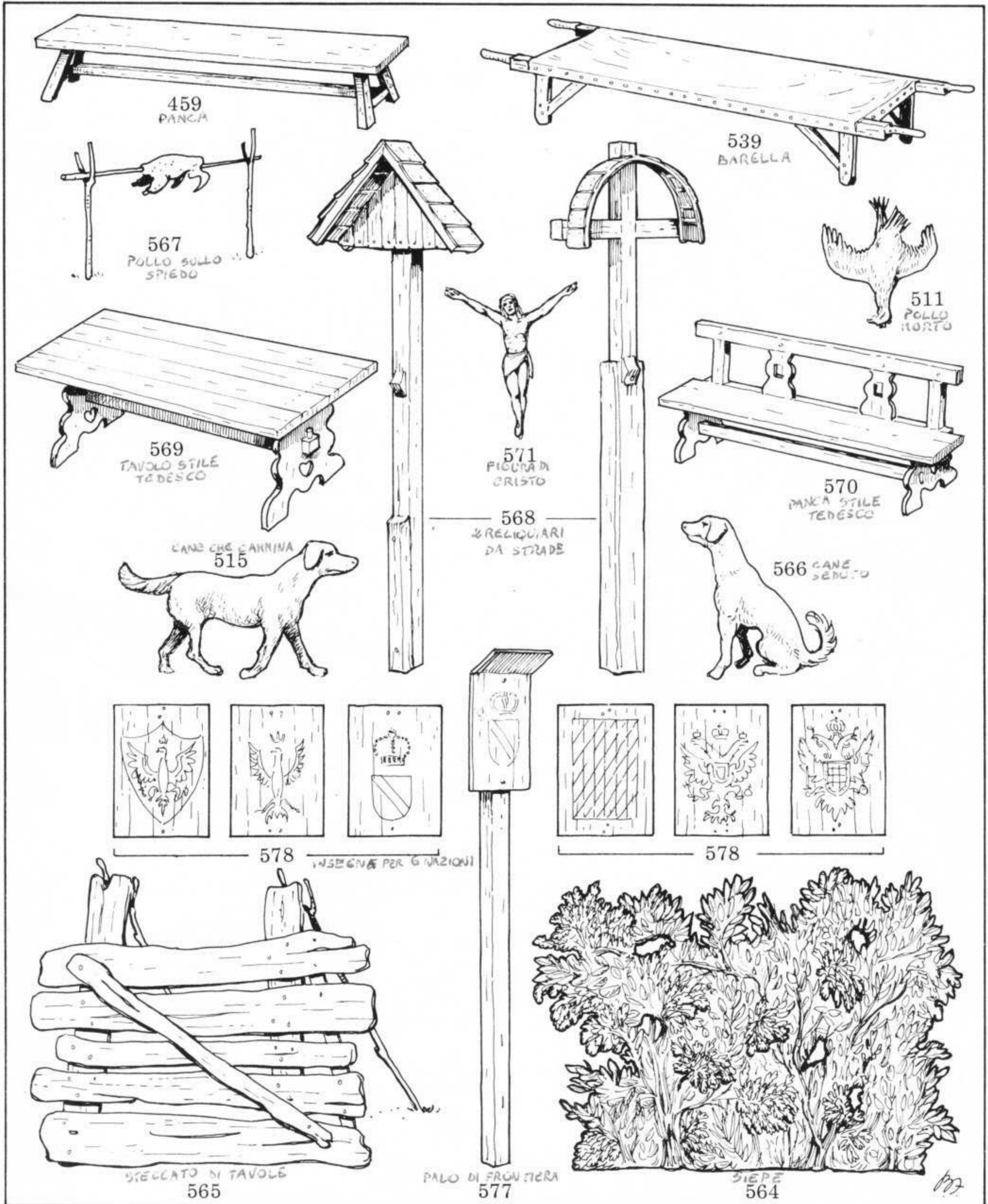

**ACCESSORY  
SPRUES**



463 UTENSILI DA CUCINA  
KITCHEN UTENSILS



EQUIPAGGIAMENTO DI  
FANTERIA DA  
CAMPAGNA  
491 INFANTRY  
CAMPAIGN  
EQUIPMENT



541 STRUMENTI PER CHIRURGO  
SURGEONS INSTRUMENTS



SECCHIO  
443



INCUSINE  
444



ATTREZZI  
DA  
FUCINA  
445



457  
TRE  
TIPI  
DI  
PILDA



SGABELLO  
460



TAVOLO DA  
458 OSTERIA



461 SEDIA



LANTERNA E  
2 BOTTIGLIE  
462

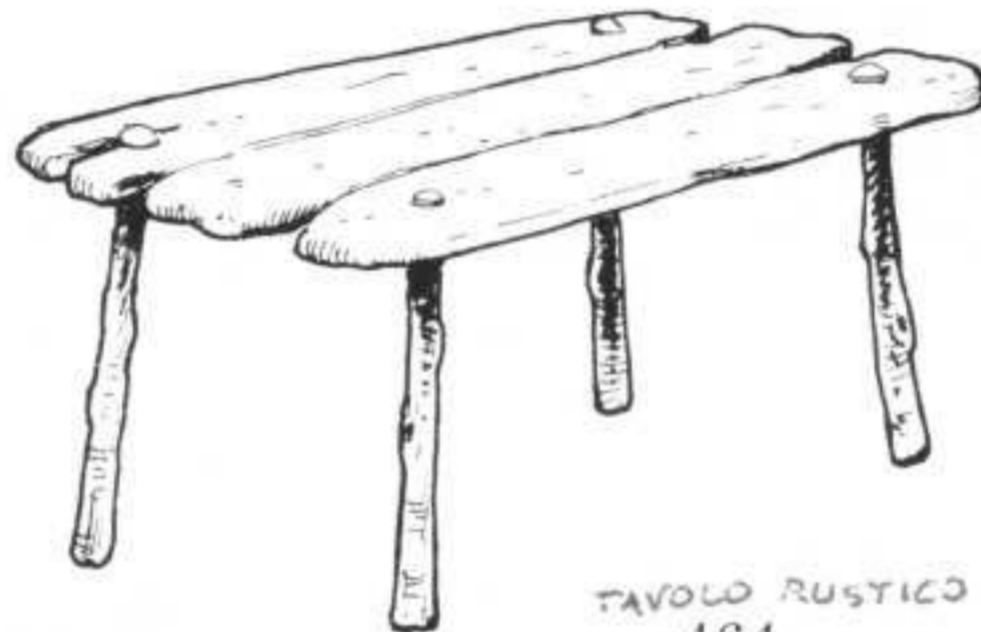

TAVOLO RUSTICO  
464

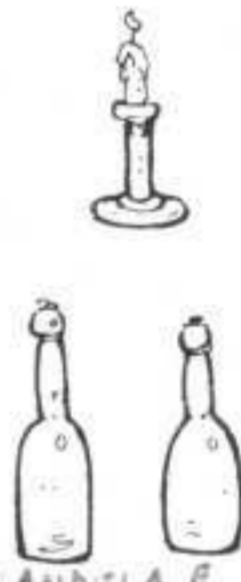

CANDOLA E  
2 BOTTIGLIE  
465

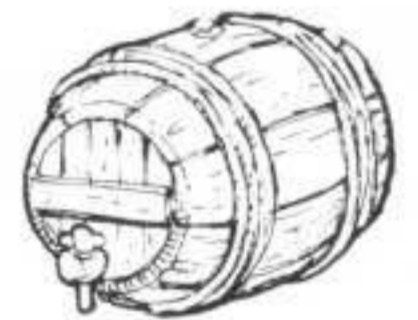

PICCOLO BARILE  
466



GRANDE BOTTE  
467

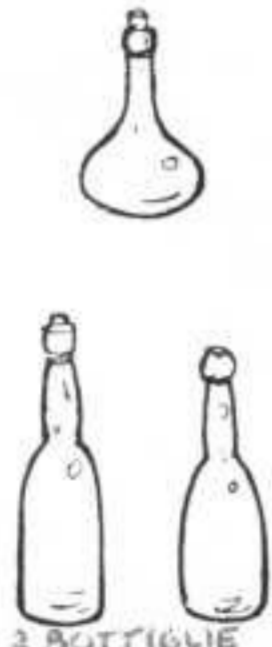

3 BOTTIGLIE  
468

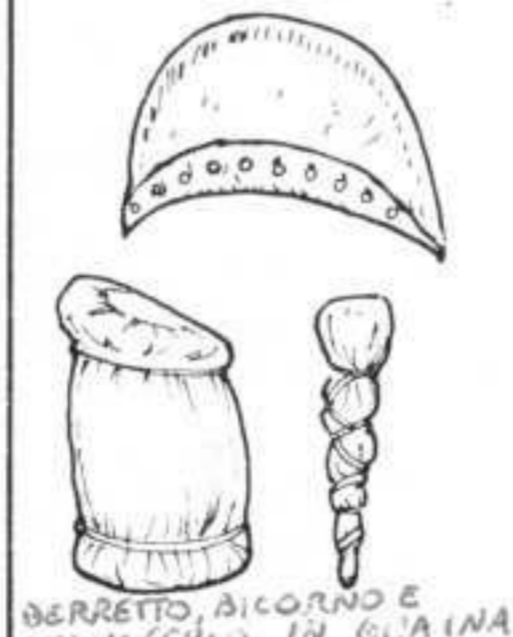

BERRETTO, SACCO E  
PENNA CCHIO IN GUAINA  
488



504 CARRIOLA



505 MOLA  
MONTATA



506

CARRUCOLA DA FENILE

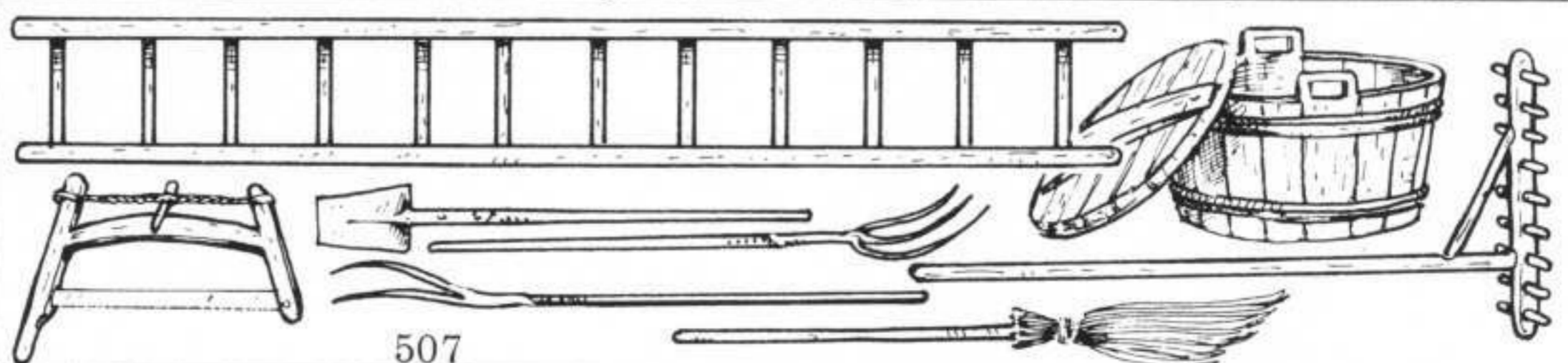

507

SCALA, SEGA, FORCONI, RASTRELLO, VANGA, SCOPA, TINOCZA

# HEADRESS

Left to Right

5  
6  
7  
8

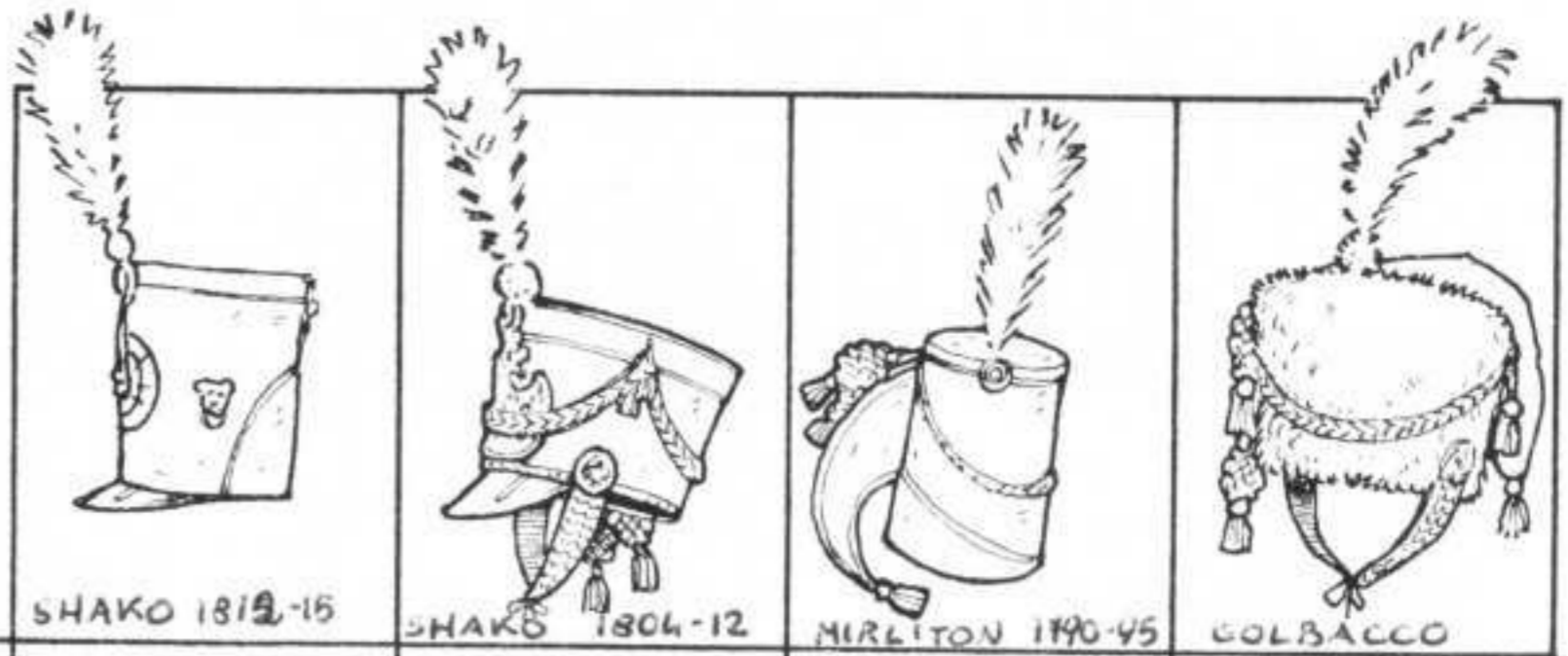

SHAKO 1812-15

SHAKO 1804-12

MIRLITON 1790-95

COLBACCO

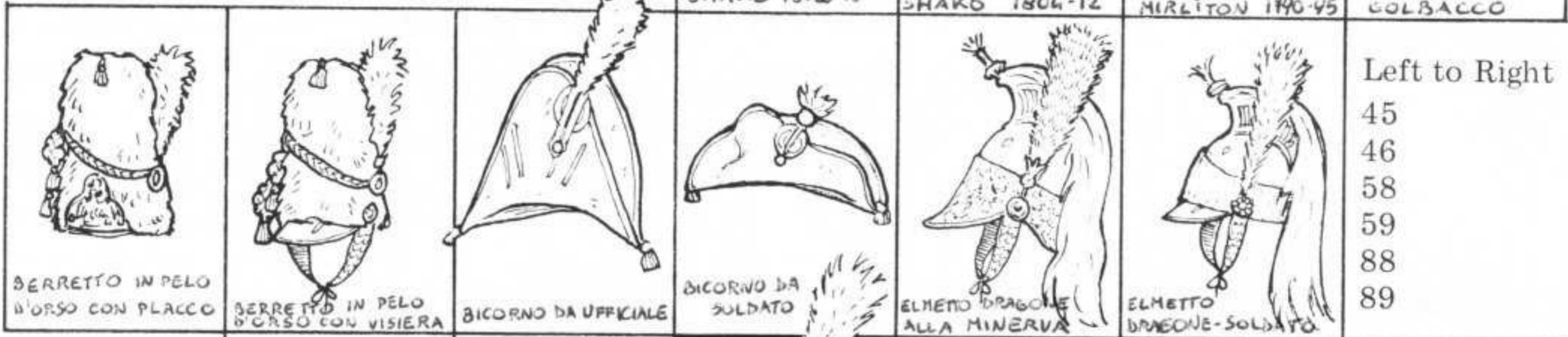

BERRETTO IN PELO D'ORSO CON PLACCO

BERRETTO IN PELO D'ORSO CON VISIERA

BICORNO DA UFFICIALE

BICORNO DA SOLDATO

ELMETTO DRAGONE ALLA MINERVA

ELMETTO DRAGONE-SOLDATO

Left to Right

45  
46  
58  
59  
88  
89

Left to Right

90  
116  
175  
176  
178  
200

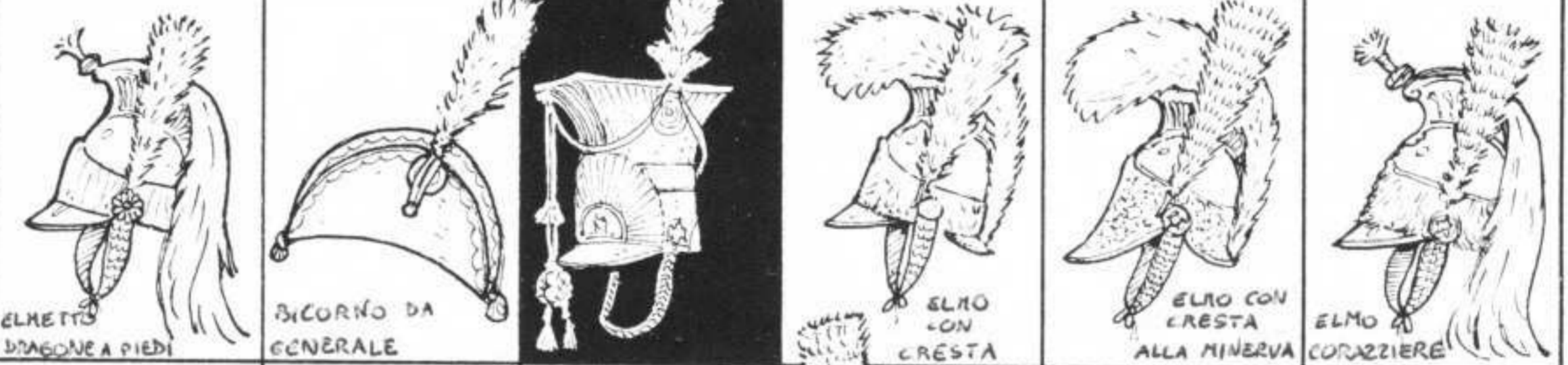

ELMETTO DRAGONE A PIEDI

BICORNO DA GENERALE

CHAPSKA

ELMO CON CRESTA DA LANCIERE

ELMO CON CRESTA ALLA MINERVA

ELMO CORAZZIERE



CHAPSKA PER MURAT



ELMO CON CRESTA DA CARABINIERE

COLBACCO CILINDRICO

BICORNO MOD. 1786

SHAKO DA ESPLORATORE

BERRETTO SLUTS GREYS

Left to Right

212  
241  
319  
336  
380  
355

Left to Right

395  
438  
441  
470  
500  
529

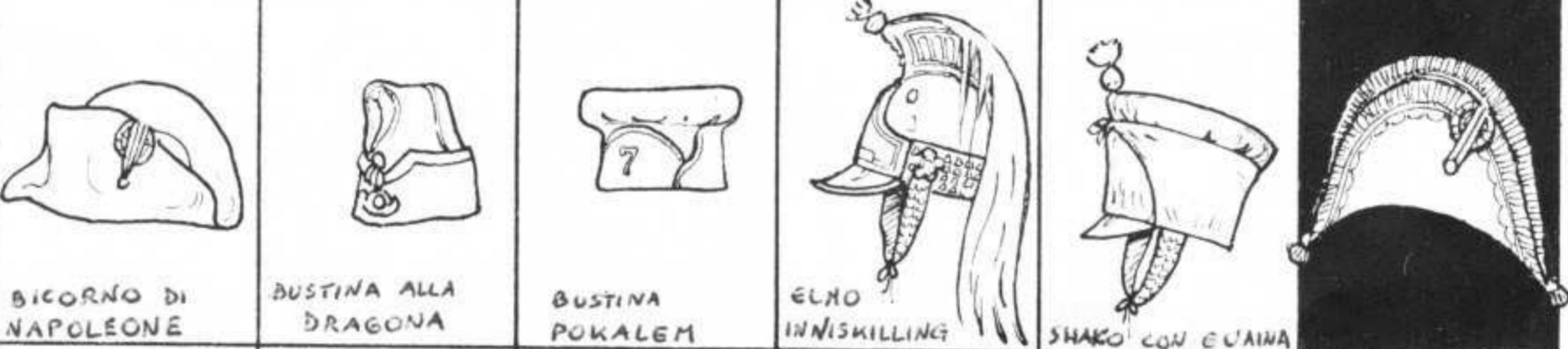

BICORNO DI NAPOLEONE

BUSTINA ALLA DRAGONA

BUSTINA POKALEM

ELMO INNISKILLING

SHAKO CON EUAINA

BICORNO DA MARESCIALLO

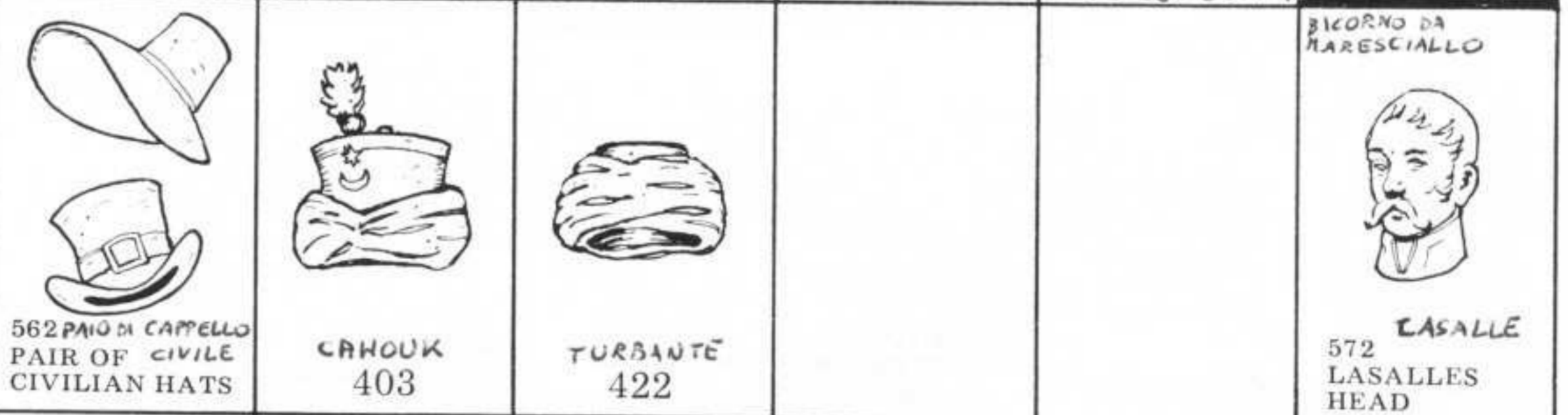

562 PAIO DI CAPPELLO PAIR OF CIVILE CIVILIAN HATS

CAHOUK 403

TURBANTE 422

572 LASALLE LASALLES HEAD

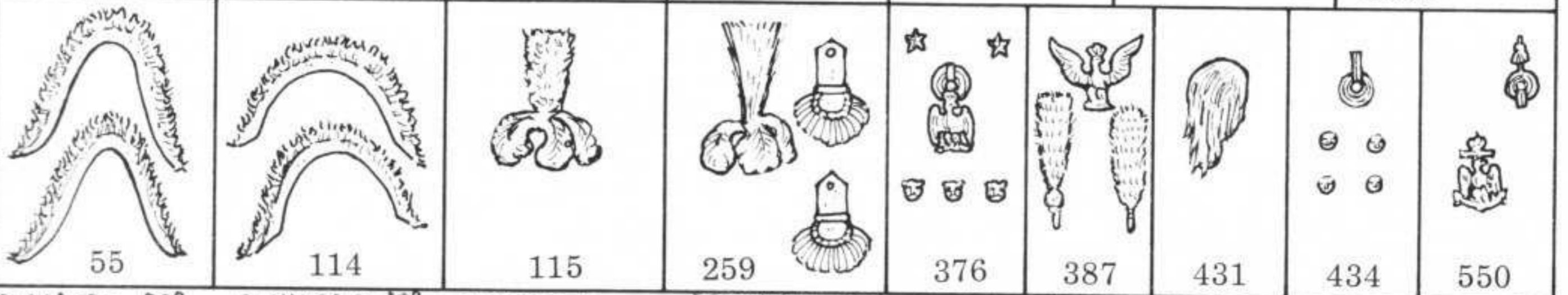

55 PIUMAGGIO PER BICORNO DA UFFICIALE

114 PIUMAGGIO PER BICORNO DA GENERALE

115 3 PUME E PENNACCHIO PER BICORNO DA GENERALE

259 PENNACCHIO E SPALLINE PER TAMBUR MAGGIORE

376 AQUILA PER SHAKO

387 AQUILA E PENNACCHIO PER ELMO GENIO

431 PENNACCHIO PENDENTE

434 COCCARDA PER SHAKO

550 AQUILA E COCCARDA PER SHAKO MARINES

# BODIES

Left to Right

- 1
- 39
- 42
- 74
- 87

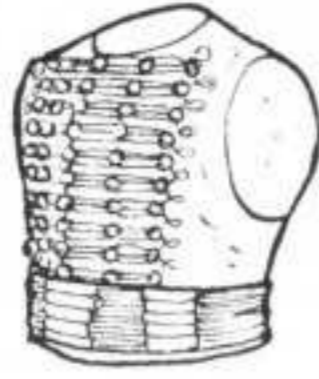

DOLMAN



PETTORINA QUADRATA

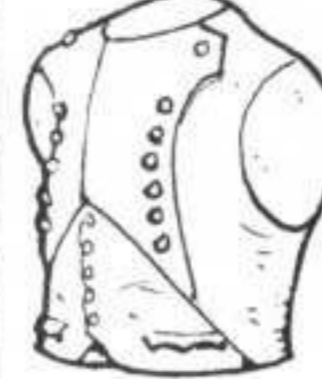

PETTORINA A PUNTA

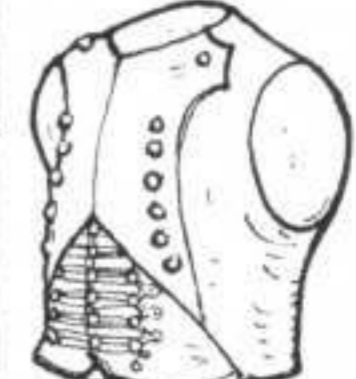

PETTORINA A PUNTA  
PANCIOFFO  
GALLONATO

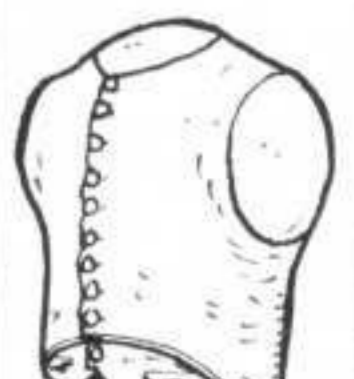

SOPRABITO A  
2 BOTTONI

Left to Right

- 126
- 132
- 169
- 171
- 173
- 201

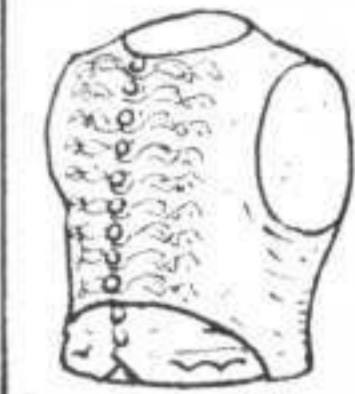

A CORDONCINI  
(PER UFF. STATO MAGGIORE)

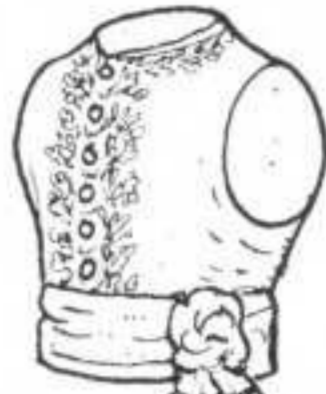

HARESCIALLO



KURTKA DA SOLDATO



KURTKA CON  
FUSCIACCIA



PETTORINA QUADRATA  
FINO IN VITA



CORAZZA, SPALLACCI  
A SCAGLIE

Left to Right

- 202
- 204
- 214
- 222
- 2
- 246

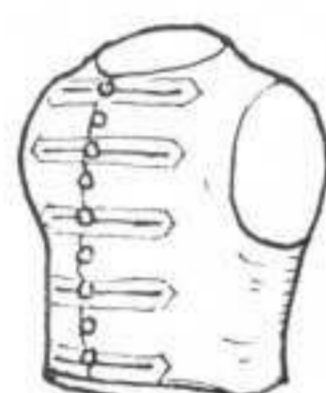

SOPRABITO CON  
BOTTONIERE



CORAZZA, SPALLACCI  
A CATENELLA



MURAT RE DI NAPOLI



PELISSE INDOSSATA



PELISSE SULLE SPALLE

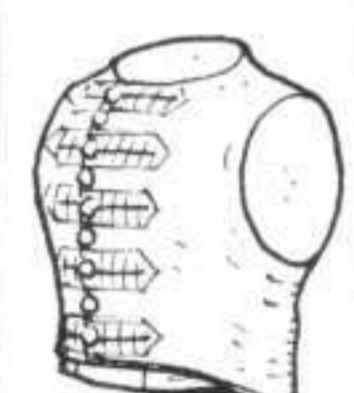

LIVREA IMPERIALE

Left to Right

- 261
- 272
- 307
- 313
- 316
- 331



TAMBURO MAGGIORE

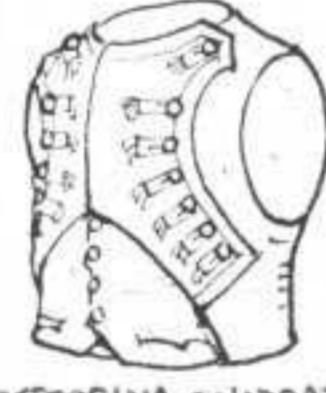

PETTORINA QUADRATA  
7 BOTTONIERE FRANGIATE



PETTORINA QUADRATA  
PER ZAPPATORE



PETTORINA A PUNTE  
PER ZAPPATORE

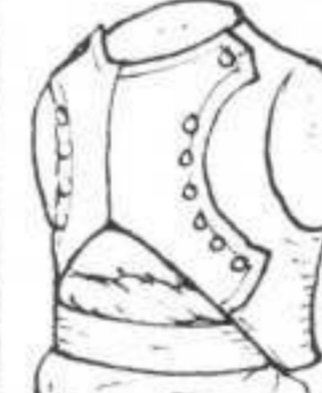

ZAPPATORE A CAVALLO

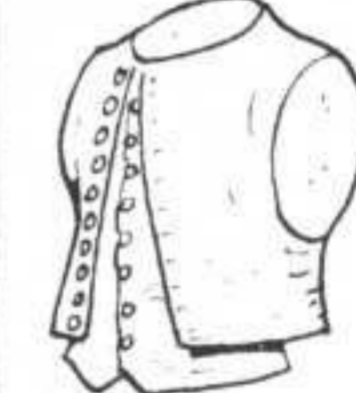

STILE 1786

Left to Right

- 350
- 356
- 360
- 381
- 399
- 405



PETTORINA RICAMATA  
A PUNTA CON FUSCIACCIA



UFFICIALE SCOTS GREYS



SOLDATO SCOTS GREYS

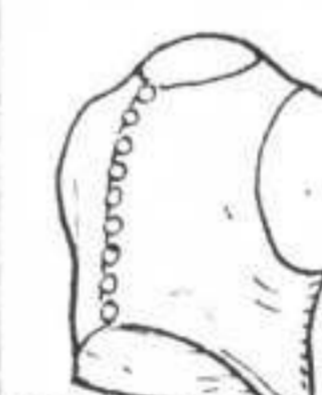

SOPRABITO  
A 9 BOTTONI  
TASCHE  
SOUBISE

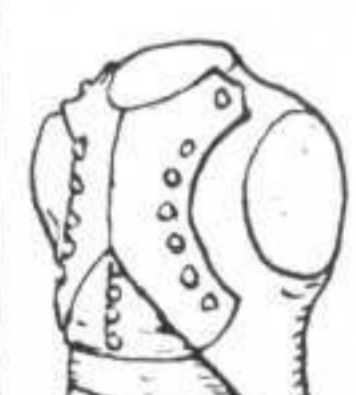

PETTORINA QUADRATA  
CON CINTURONE

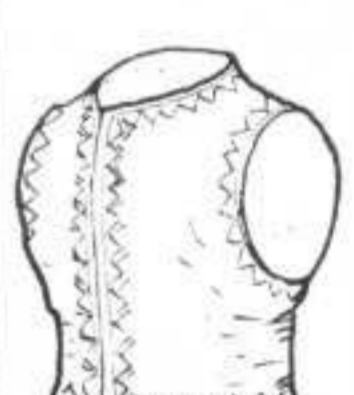

HAMELUCCO

Left to Right

- 430
- 439
- 449
- 496
- 524
- 533

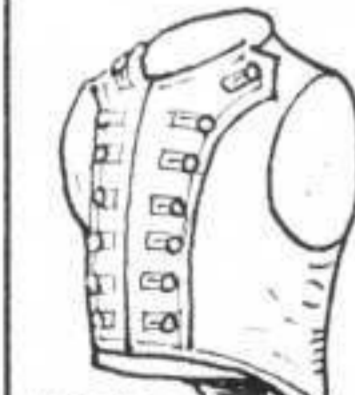

KURTKA  
CON  
BOTTONIERE  
GALLONATE

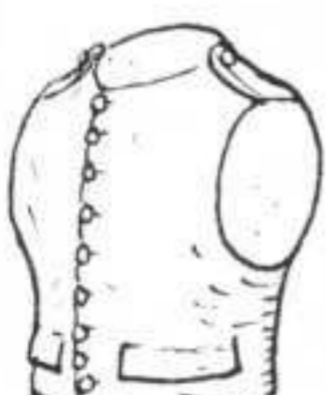

GIACCA DA STALLA



SOPRABITO CON  
PANCIOFFO GALLONATO

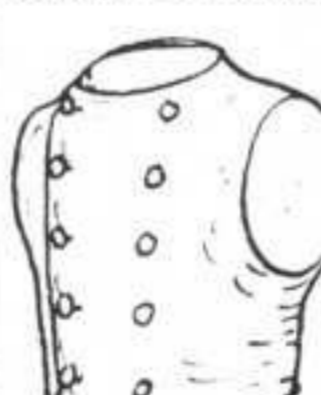

CAPPOTTO

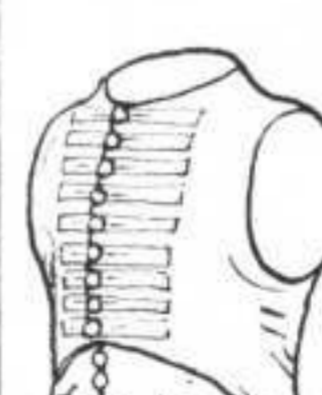

SOPRABITO A 9  
BOTTONI CON ALMARI



BARONE LARREY

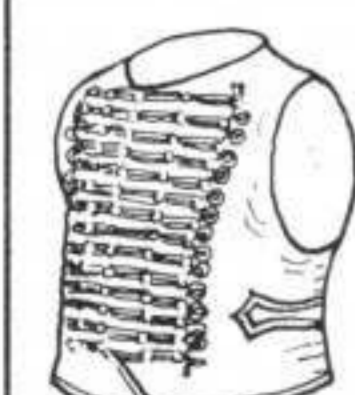

549

DOLMAN MARINES

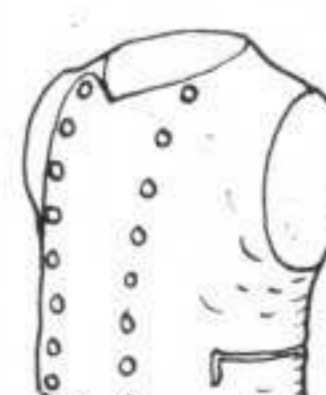





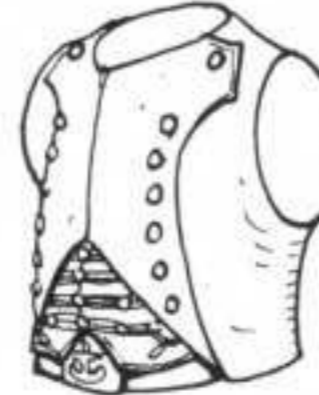













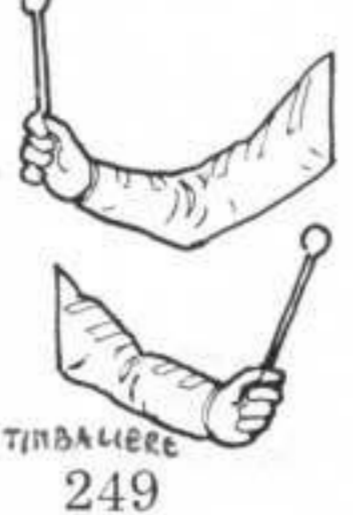
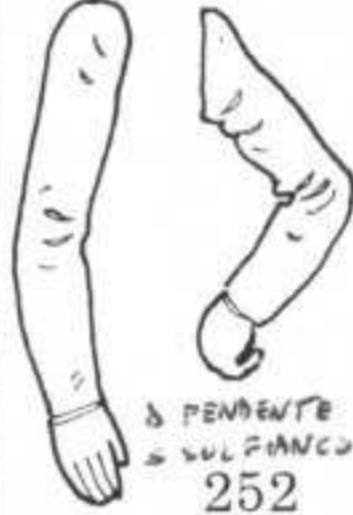
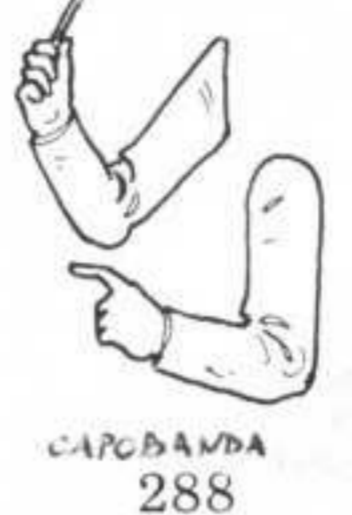





















554

CARACO MARINES





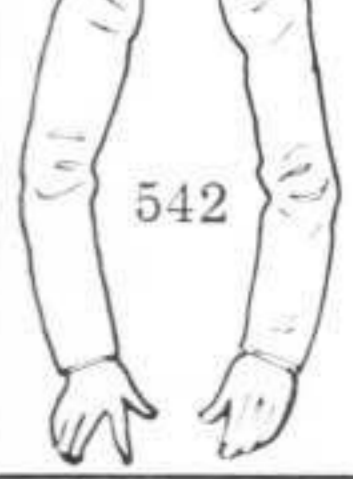







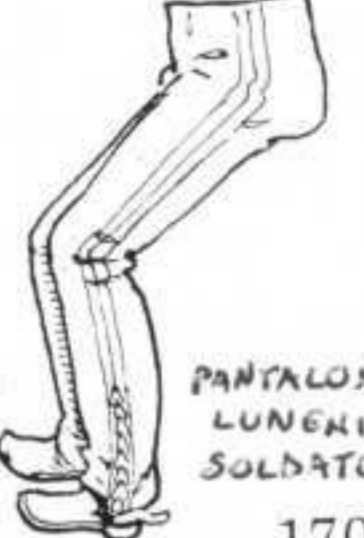
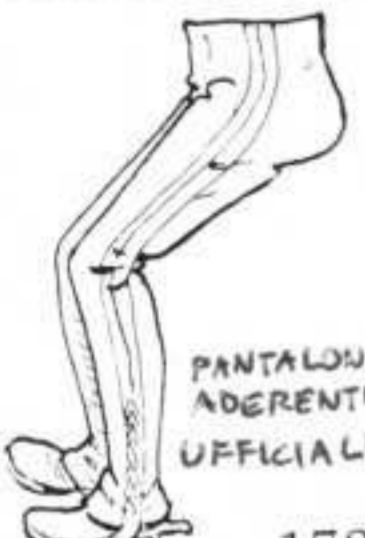



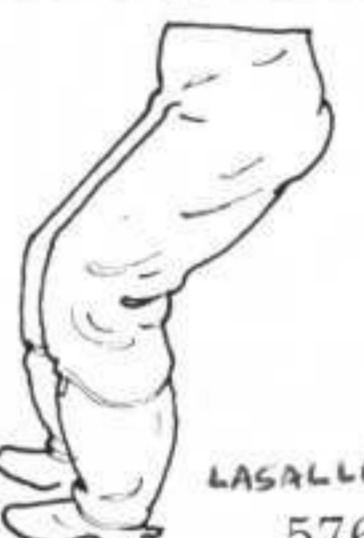
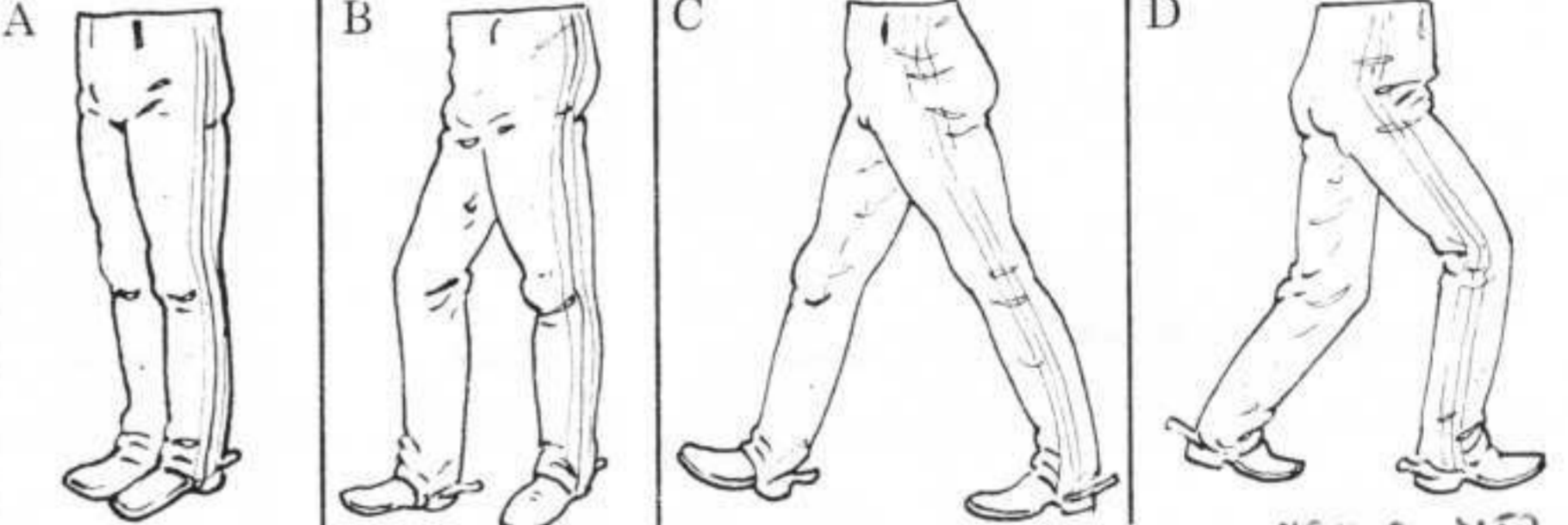
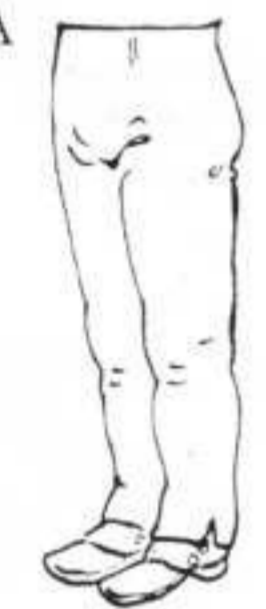
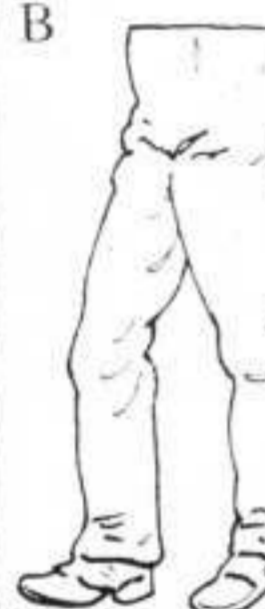

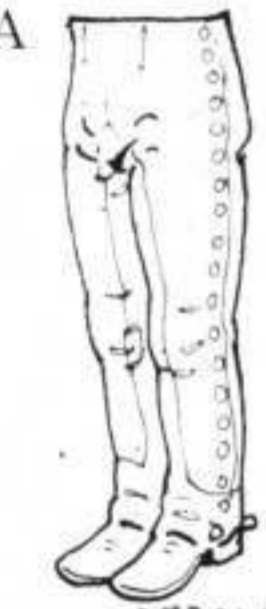

545

PETTORINA A PUNTA  
PANCIOFFO GALLONATO  
CON CINTURA

<p><b>PAIRS OF ARMS</b></p>	 <p>DX PORTASCIABOLI S PENDENTE 19</p>	 <p>D PORTACORNETTA S PENDENTE 22</p>	 <p>D PRESENTA' ARM S TIENE REDINI 30</p>	 <p>TAMBURO CON BACCHETTE 52</p>	 <p>D DISTESO S TIENE REDINI 162</p>	 <p>D INDICANTE S SUL PIANCO 219</p>
 <p>D SUL PIANCO S PENDENTE 220</p>	 <p>D INDICANTE S PENDENTE 221</p>	 <p>TIMBALIERE 249</p>	 <p>S PENDENTE S SUL PIANCO 252</p>	 <p>CAROBANDA 288</p>	 <p>JINGLING JOHNNIE 289</p>	 <p>GRANCASSA 290</p>
 <p>CITRALI 291</p>	 <p>TRIANGOLO 292</p>	 <p>FAGOTTO 293</p>	 <p>OSUÈ 294</p>	 <p>FLAUTO 295</p>	 <p>TROMBONE 296</p>	 <p>SERPENTE 297</p>
 <p>TROMBA 298</p>	 <p>CORNO 299</p>	 <p>SOTTUFF. ZAPPATORI 300</p>	 <p>ZAPPATORIA CIV. 301</p>	 <p>ZAPPATORI A PIEDI 304</p>	 <p>D PORTASCIABOLI S TIENE REDINI 374</p>	 <p>S PORTASCIABOLI S PENDENTE 392</p>
 <p>D PENDENTE S TIENE REDINI 394</p>	 <p>419 TIMBALIERE MANICUCCHI</p>	 <p>TAMBURO 421</p>	 <p>FABBRIO 446</p>	 <p>AIUTANTE FABBRIO 447</p>	 <p>ARTIFICIERE 448</p>	 <p>ENTRAMBE SULL'ANCA 469</p>
 <p>D PORTASTENDINI S SUL PIANCO 472</p>	 <p>D ALL'INDIETRO S SUL CAMPIDANO 473</p>	 <p>DIRITTE INDIETRO 476</p>	 <p>D PORTASTENDINI S INDIETRO 482</p>	 <p>D PORTASCIABOLI S PENDENTE 489</p>	 <p>D PORTASTENDINI S PENDENTE 493</p>	 <p>D PENDENTE S PORTA CINGHIA SUL ROSEMETTO 494</p>
 <p>542</p>	 <p>560</p>	 <p>575</p>				

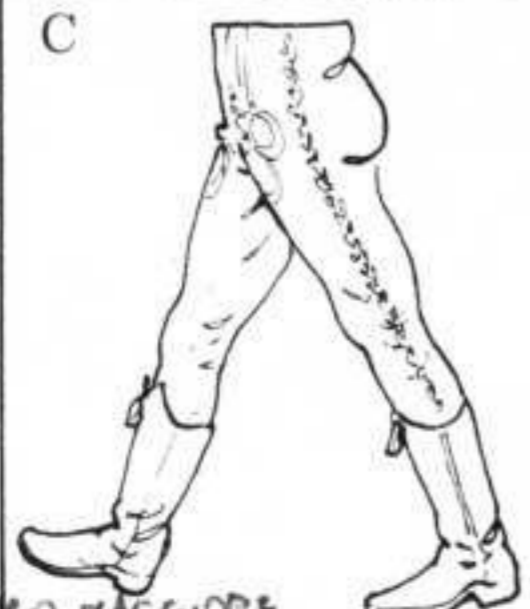
D PORTASTENDINI S PENDENTE  
 MANICHE ARROTONDATE  
 D TIENE LA PIPA S DENTRO LE SPALLE

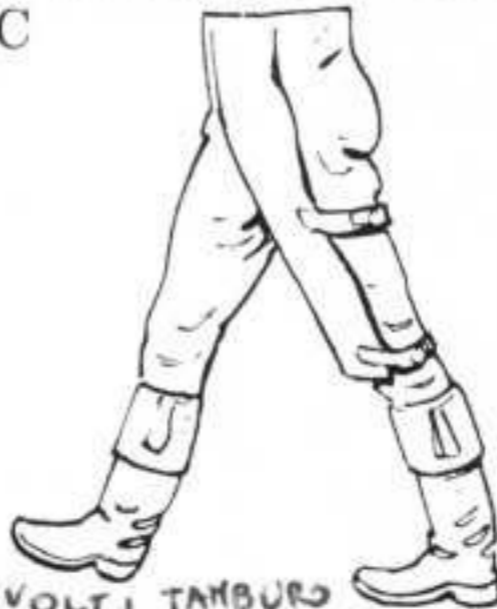
<b>RIDING LEGS</b> <b>GAMBE CAVALIERI</b>		 <p>STIVALI DA CAVALLO CON GINOCCHIERE 36</p>	 <p>STIVALI ALLA USSARA 51</p>	 <p>STIVALI CON RISVOLTI 157</p>	 <p>PANTALONI LUNGI SOLDATO 170</p>						
		 <p>PANTALONI ADERENTI UFFICIALE 172</p>	 <p>GAMBALI CON BUTTONI 174</p>	 <p>STIVALI ALTI 227</p>	 <p>GAMBALI SENZA BUTTONI 382</p>	 <p>MAMELUCCO 407</p>	 <p>LASALLE 576</p>				
<b>STANDING LEGS</b> <b>GAMBE PEDONI</b>		<p>(A) ATTENTION      ATTENTI          (B) EASY              RIPOSO          (C) PARADE          PARATA          (D) ATTACK          MARCIA</p>									
		 <p>CALVALRY TROUSERS      PANTALONI LUNGI SOLDATO</p>									
 <p>A</p>		 <p>B</p>		 <p>C</p>		 <p>D</p>		 <p>A</p>		 <p>B</p>	
<p>INF TROUSERS      PANTALONI FANTERIA</p>		<p>HUNGARIAN      STIVALI USSARA</p>									
 <p>A</p>		 <p>B</p>		 <p>A</p>		 <p>B</p>		 <p>A</p>		 <p>B</p>	
<p>GAMBALI CON BUTTONI BUTTON OVERALLS</p>		<p>MAMELUCCO MAMELUCCO</p>		<p>STIVALI ALTI LONG PLAIN BOOTS</p>		<p>ADERENTI UFFICIALE TIGHT LANCER</p>					
 <p>A</p>		 <p>C</p>		 <p>A</p>		 <p>C</p>					
<p>TAMBURRO MAGGIORE DRUM MAJOR</p>		<p>STIVALI CON RISVOLTI TAMBURRO TURNED OVER DRUM CLOTH</p>									

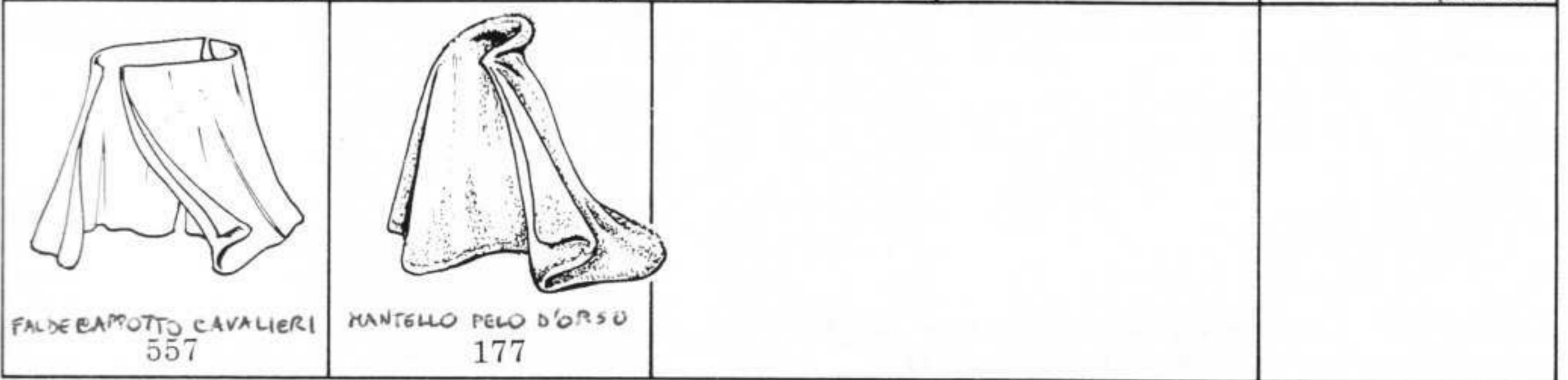
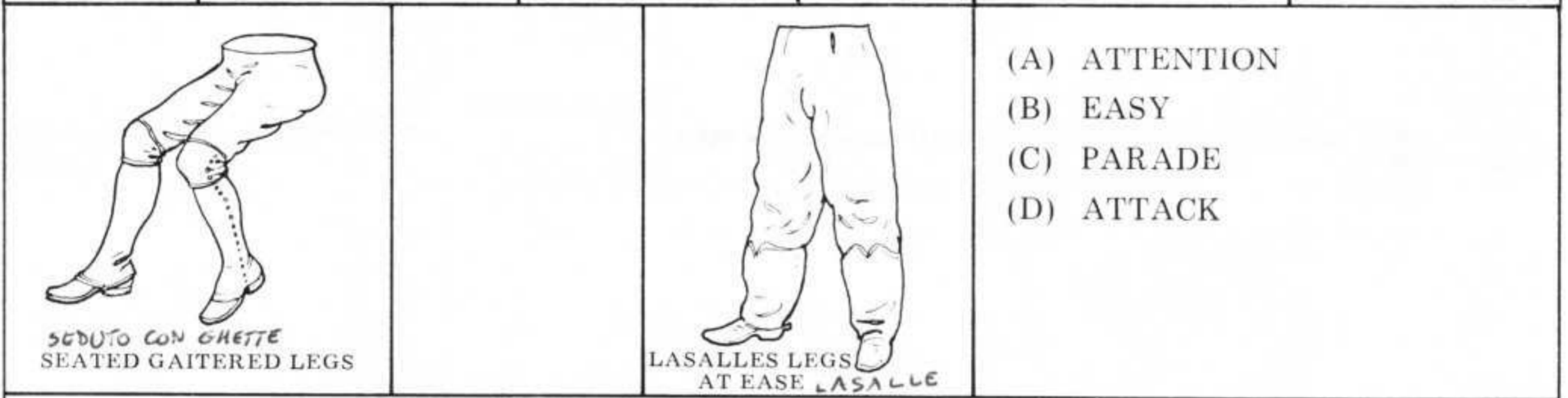
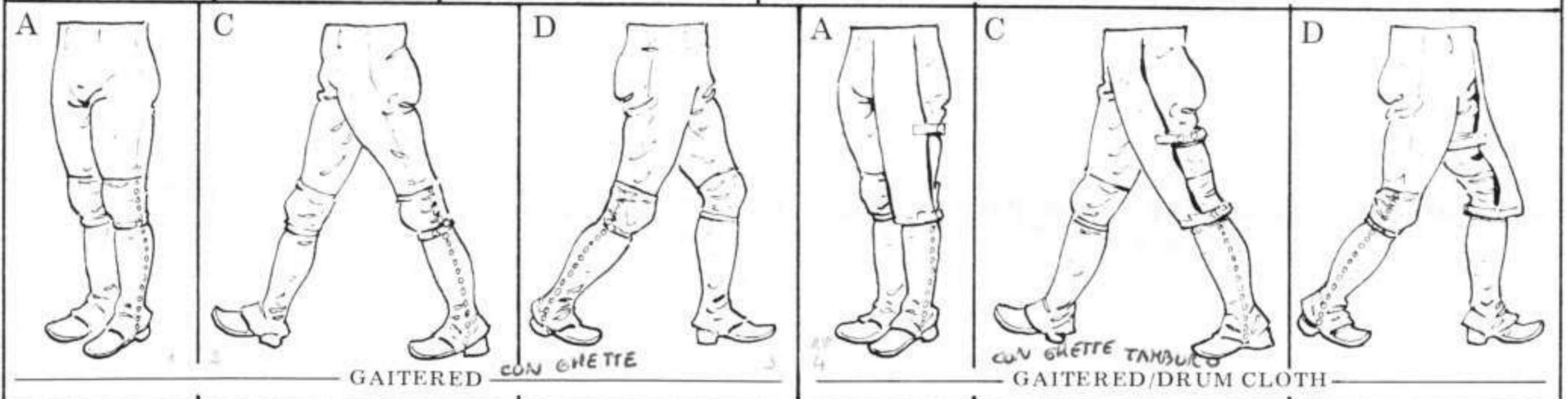
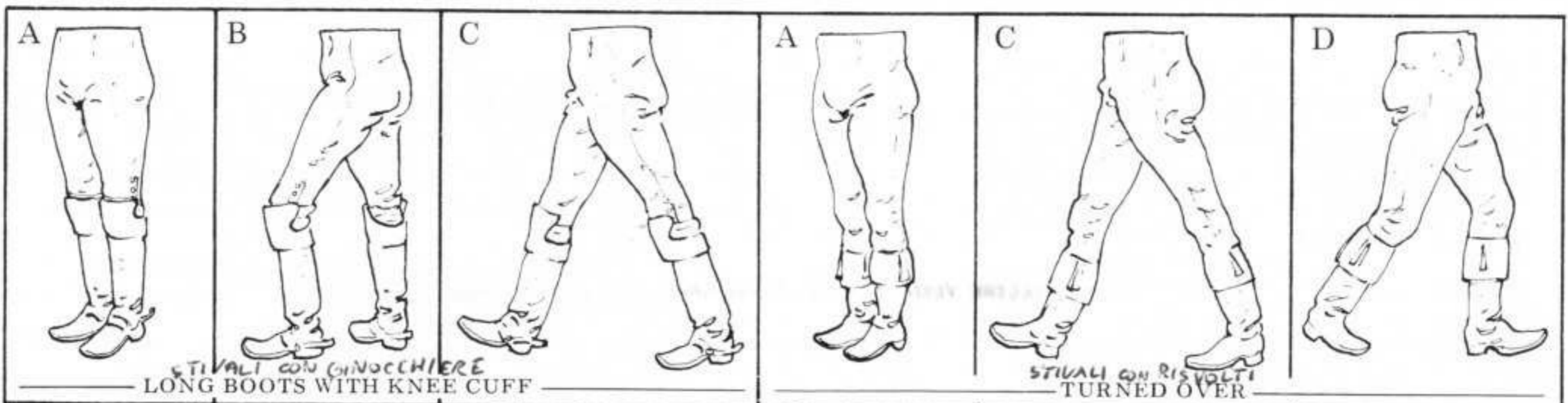

<b>COAT TAILS</b> <b>Standing</b> <b>FALDE GIACCA</b> <b>PEDONI</b>		 CORTE, TASCHE VERT. 43	 LUNGHE, TASCHE VERT. 65	 LUNGHE RICAMATE, TASCHE 218 ORIZZ.	 CORTE RICAMATE, TASCHE VERT. 238	 EXTRA CORTE, TASCHE VERT. 243	
 LUNGHE, TASCHE VERT. 262 ATTENTI	 LUNGHE, TASCHE VERT. 265 MARCIA	 LUNGHE, TASCHE VERT. GALLOVATE 273	 LUNGHE, TASCHE ORIZZ. GALLOVATE 286	 CORTE, TASCHE VERT. GALLOVATE 306	 PER PAROCIA LLO SENZA 347 RISVOLTI	 CORTE RICAMATE, TASCHE ORIZZONTALI 349	
 LUNGHE, TASCHE VERT. 352 PEDONI	 LUNGHE 375 SPOGLIE	 LUNGHE, TASCHE ORIZZ. 391	 LUNGHE, TASCHE SOUBISE 398	 CORTE, TASCHE SOUBISE 501	 LUNGHE, TASCHE ORIZZ. 523 BOTTONI	 LUNGHE, TASCHE ORIZZ. 527 BOTTONI GALLOVATE	
 LUNGHE, TASCHE ORIZZ. 531 BOTTONI GALLOVATE PER SOPRABITO	 LUNGHE, TASCHE ORIZZ. 544 BOTTONI FALSI RISVOLTI	 LUNGHE SPOGLIE FALSI 548 RISVOLTI	<b>COAT TAILS</b> <b>Mounted</b> <b>FALDE GIACCA</b> <b>CAVALIERI</b>			 LUNGHE SPOGLIE 38	 CORTE SPOGLIE 67
 LUNGHE RICAMATE SENZA RISVOLTI 199 TASCHE ORIZZ.	 LUNGHE RICAMATE CON RISVOLTI 217 TASCHE ORIZZ.	 EXTRA CORTE TASCHE VERT. 243	 LUNGHE, TASCHE VERT. GALLOVATE 258	 LUNGHE, TASCHE ORIZZ. GALLOVATE 287	 LUNGHE, PUNTO STILE 333	 CORTE, RICAMATE TASCHE ORIZZ. 343	
 LUNGHE RICAMATE TASCHE VERT. 353	 LUNGHE, TASCHE 378 VERT.	 LUNGHE, TASCHE ORIZZ. 388	 CORTE, TASCHE ALLA SOUBISE 433	 CORTE, TASCHE ALLA SOUBISE FALSI, RISVOLTI 436	 CORTE, TASCHE VERT, FALSI RISVOLTI 440	 LUNGHE, TASCHE ALLA SOUBISE FALSI, RISVOLTI 451	
 LUNGHE, TASCHE ORIZZ. 326 BOTTONI	 LUNGHE, TASCHE ORIZZ. 530 BOTTONI GALLOVATE	 LUNGHE, TASCHE ORIZZ. 534 PER SOPRABITO	 LUNGHE, TASCHE ALLA SOUBISE 400	 LUNGHE, TASCHE ORIZZ. 547 BOTTONI FALSI, RISV.	 LUNGHE SPOGLIE FALSI 551 RISV.		



# MUSKETS AND SWORDS



48  SCIABOLA CURVA UFFICIALE FANTERIA	49  SPADA DRITTA UFFICIALE FANTERIA	72  SCIABOLA CAVALL. LEGG. ELSA A 3 RAMI	92  SCIABOLA CURVA CON PIGNA GRANATA SULL'ELSA	78  SCIABOLA CURVA CON PIGNA GRANATA SULL'ELSA	94  SCIABOLA DRITTA ELSA A 3 RAMI	108  SCIABOLA CAVALL. LEGG.	117  SCIABOLA PER GENERALE	155  SCIABOLA TAMBURINO	158  SCIABOLA FANTERIA CON GRANATA SULL'ELSA
192  SCIABOLA DRITTA ELSA A 3 RAMI DI GIOIELLO	203  SCIABOLA DRITTA CONCHIAVATA SULL'ELSA	213  SCIABOLA MANELUCCHI	228  SCIABOLA DRITTA ELSA 3 RAMI	229  SCIABOLA E BAIONETTA DA FANTERIA	237  SCIABOLA DRITTA UFF. CARABINIERI	240  SCIABOLA DRITTA QUADRATA CARABINIERI	242  SCIABOLA SEMICURVA UFF. CARABINIERI	245  SCIABOLA SEMICURVA QUADRATA CARABINIERI	253  SCIABOLA USSARI AN IV°
303  SCIABOLA ZAPPATORE CON IMPUGNATURA TESTA D'AQUILA	310  SCIABOLA INGUAINATA DA ZAPPATORE	311  ASCIA E FODERO FANTERIA	312  SCIABOLA FANTERIA	314  ASCIA E FODERO CAVALLERIA	340  SCIABOLA CURVA FANTERIA GRANATA SULL'ELSA	363  SCIABOLA DRITTA CAVALLERIA INGLESE	397  SCIABOLA NAPOLEONE	409  SCIABOLA ORIENTALE MANELUCCO	556  SCIABOLA MARINES

A HISTOREX horse is composed of two body halves, a head, mane, tail and forelock. We have numbered the different parts, putting the head first, then the left half and finally the right half. By combining the different halves it is possible to make up a horse in many different positions. Some examples are shown opposite of the four basic positions — Standing, walking, trotting, galloping. Heads are suitable for any combination of the horse halves with the exception of No.6.

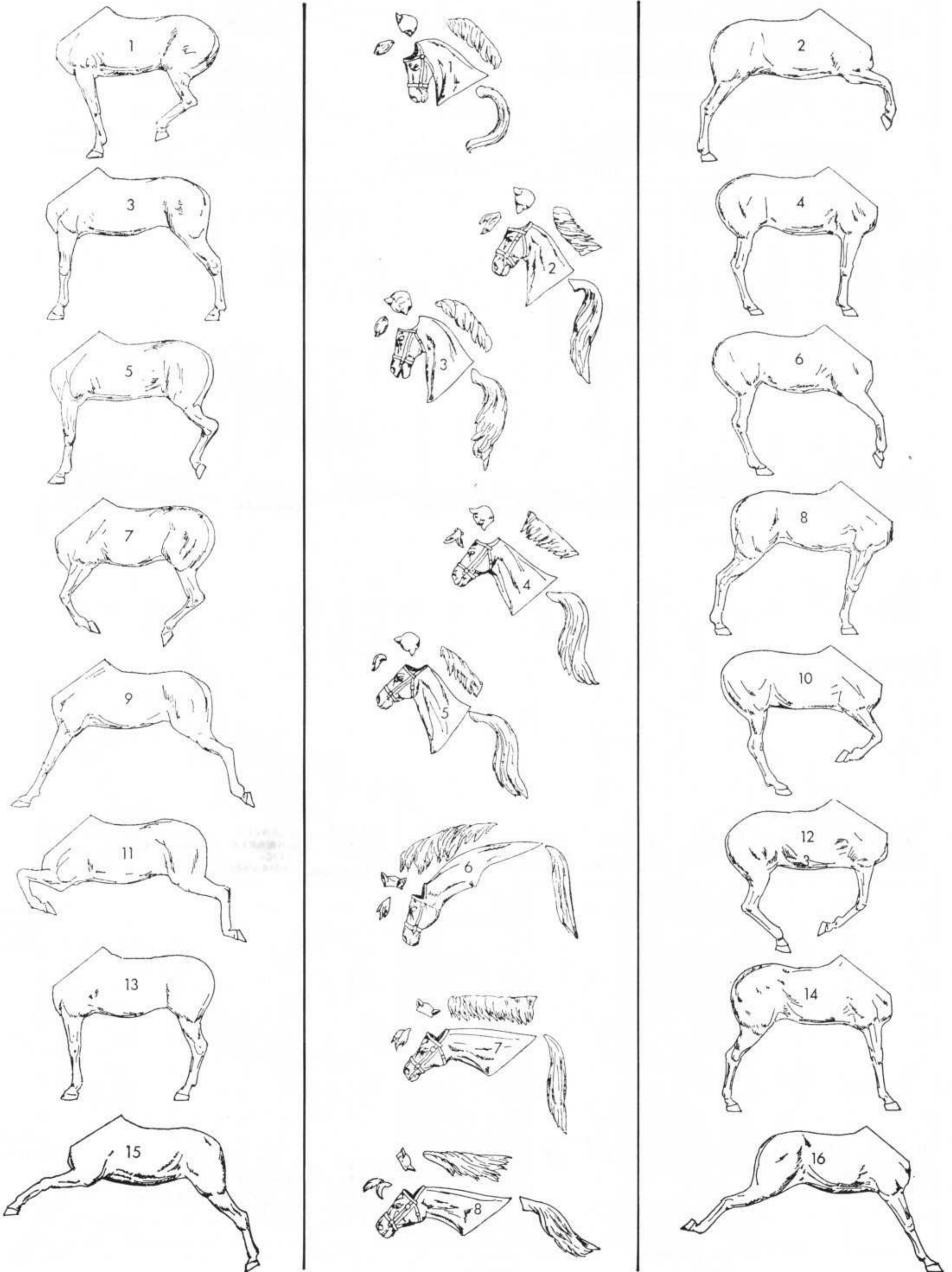

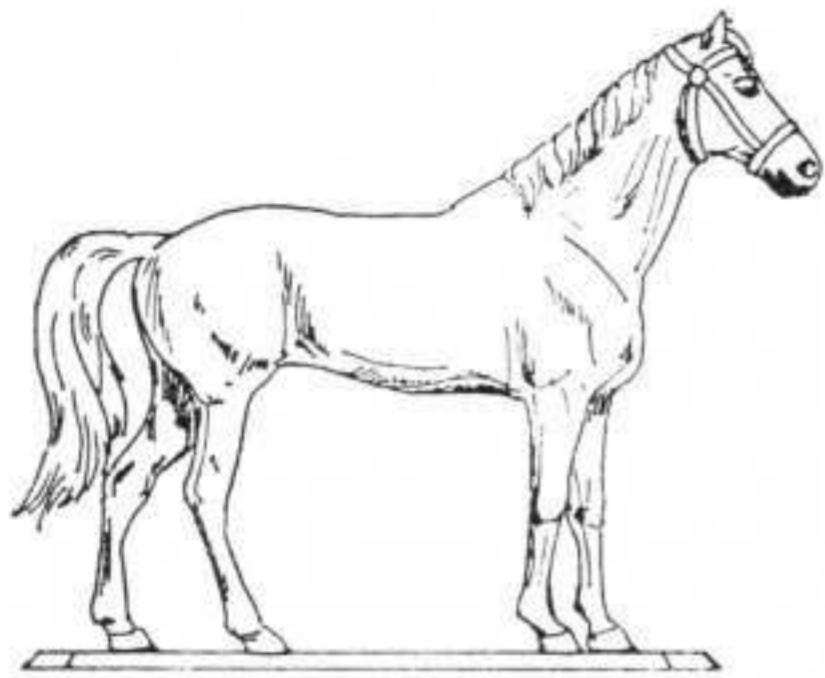

Example of standing horse — 4.3.4.

Standing Horses —  
 Body halves (3-4) (3-2) (1-4)  
 (1-8) (3-8) (5-4) (5-8) (13-14)  
 (3-14) (8-13) (1-14) (4-13) (5-14)  
 (6-13) (10-13) (2-13)

Walking Horses —  
 Body Halves (1-6) (3-6)  
 (5-6) (7-4) (7-8) (3-10) (3-12)  
 (7-14)

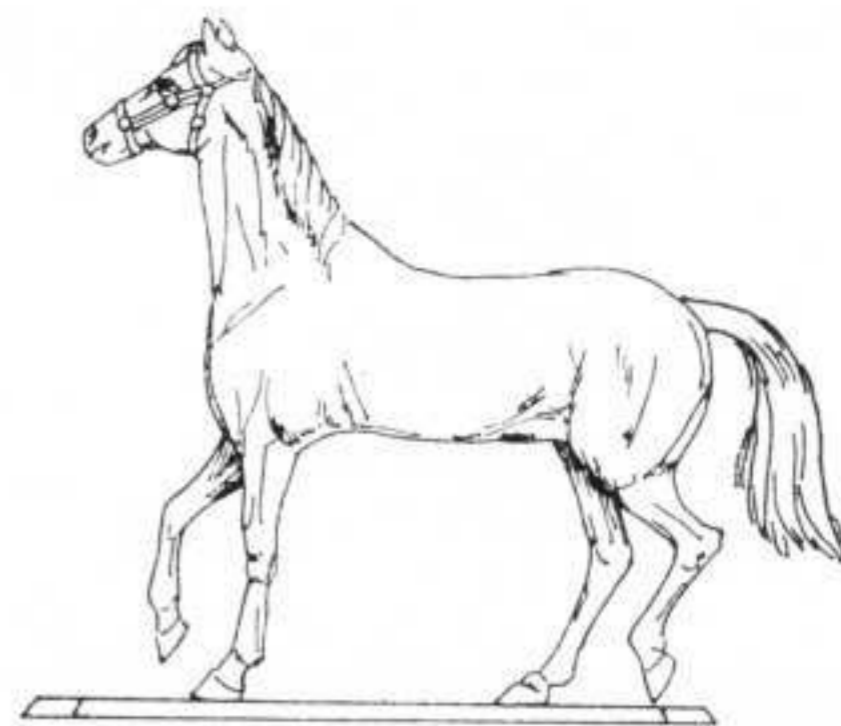

Example of walking horse — 5.5.6.

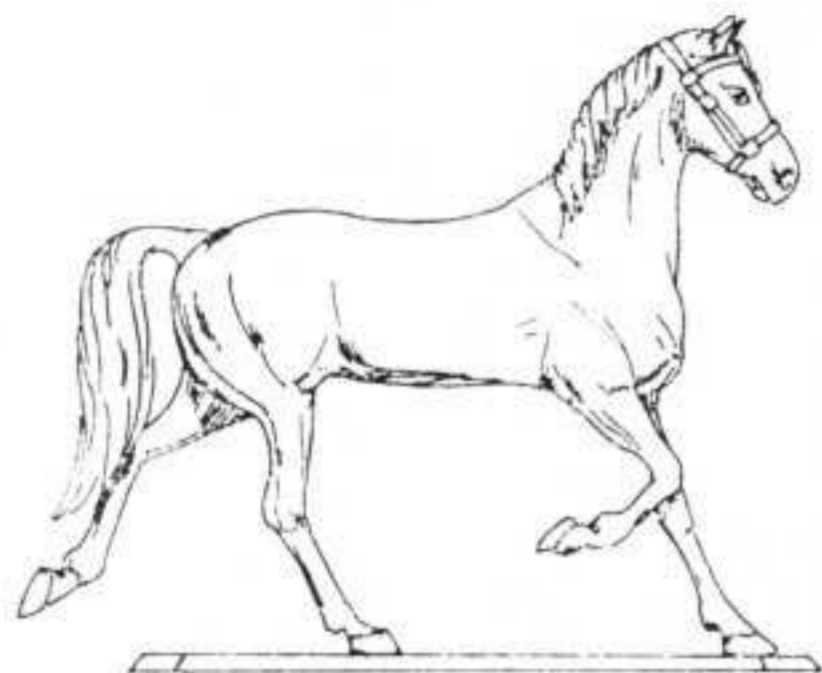

Example of trotting horse — 2.9.10.

Trotting Horses —  
 Body halves (1-2) (5-2)  
 (9-10) (9-6) (9-12) (11-6)  
 (12-15) (7-16)

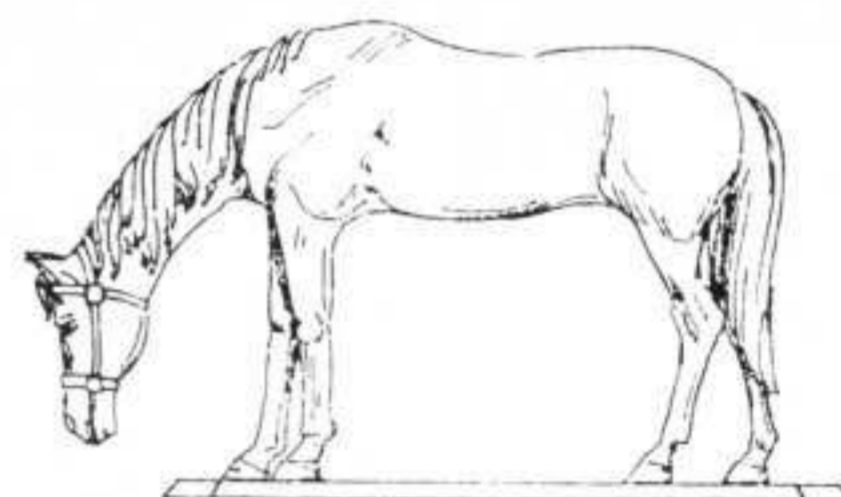

Example of grazing horse —  
 6.13.14.

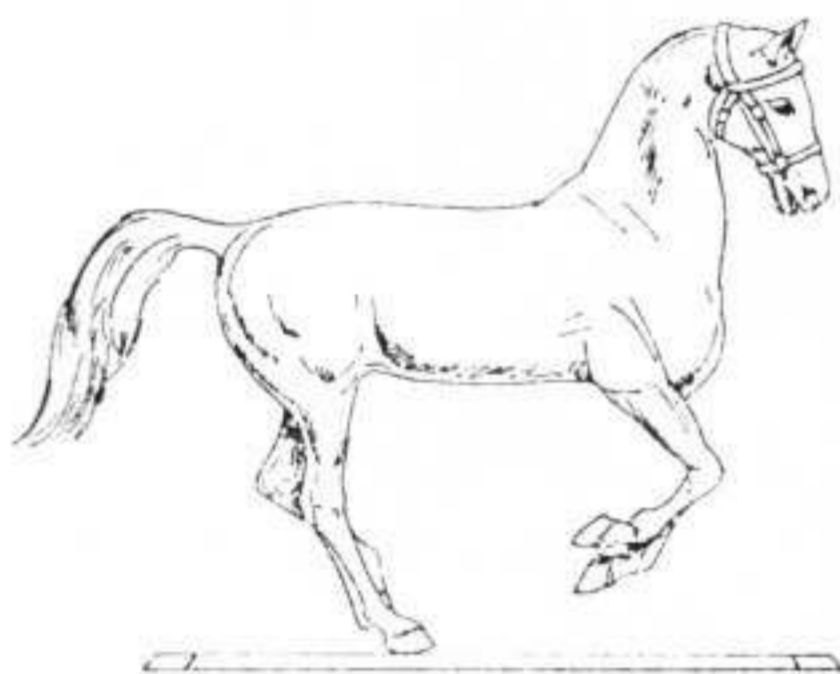

Example of galloping horse —  
 3.7.10.

Galloping Horses —  
 Body Halves (7-6) (9-2) (9-8)  
 (7-10) (7-2) (1-12) (5-12) (7-12)  
 (11-2) (11-10) (2-5) (10-15)  
 (11-16) (15-16)

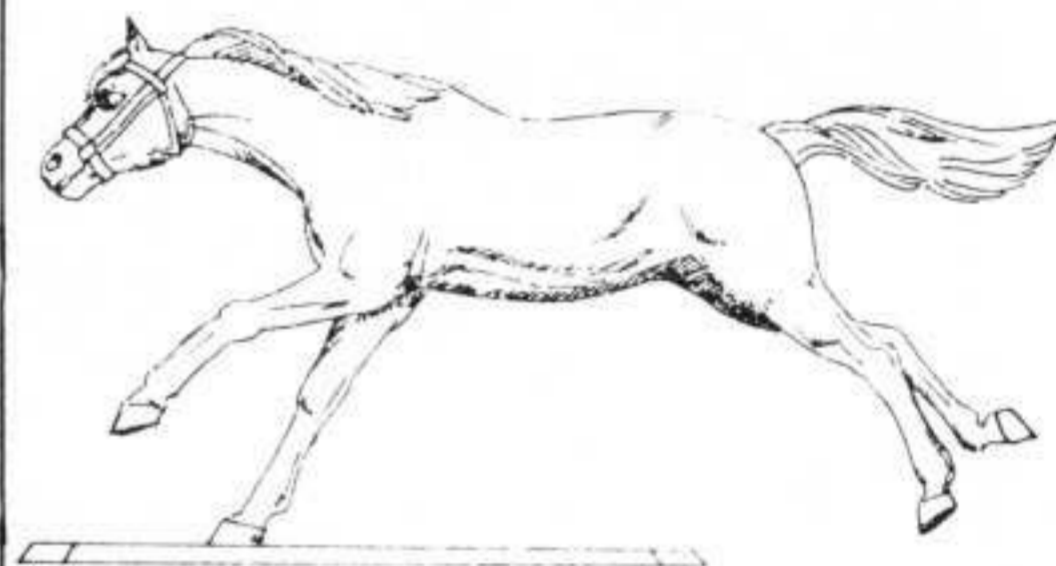

Example of full gallop horse —  
 8.15.16.

Various other positions possible:  
 Piaff — halves 1.10.  
 Recoiling — halves 5.10.  
 Rearing — halves 11.12.  
 Impatient (pawing) 14.15.  
 Full gallop 15.16.  
 Kicking — halves 5.16.  
 Kicking — halves 9.16.  
 Spanish step — halves 4.15.  
 Stretched horse — halves 7.16 (with head  
 6).

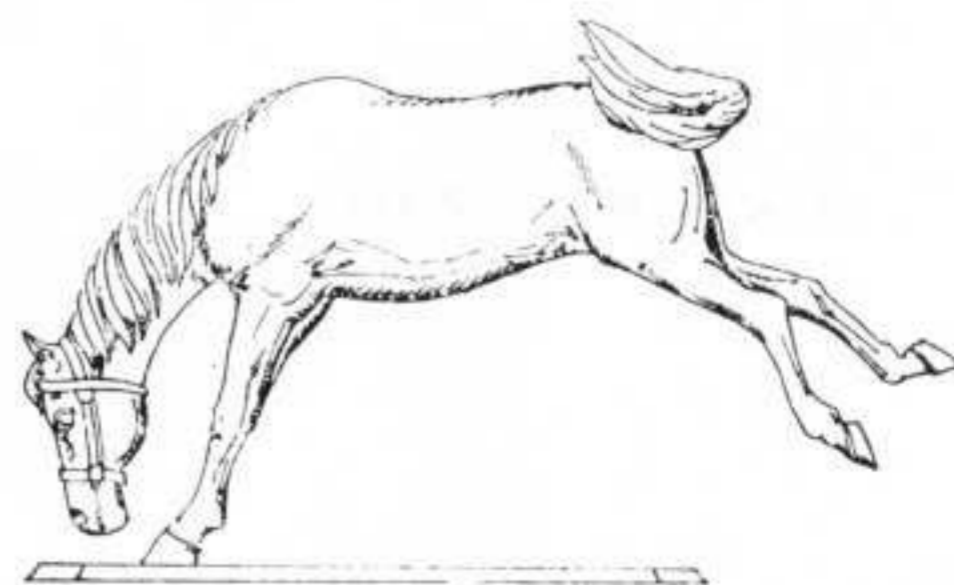

Example of bucking horse —  
 6.9.16.

# SADDLERY

ALL NUMBER READ FROM LEFT TO RIGHT

9  
10

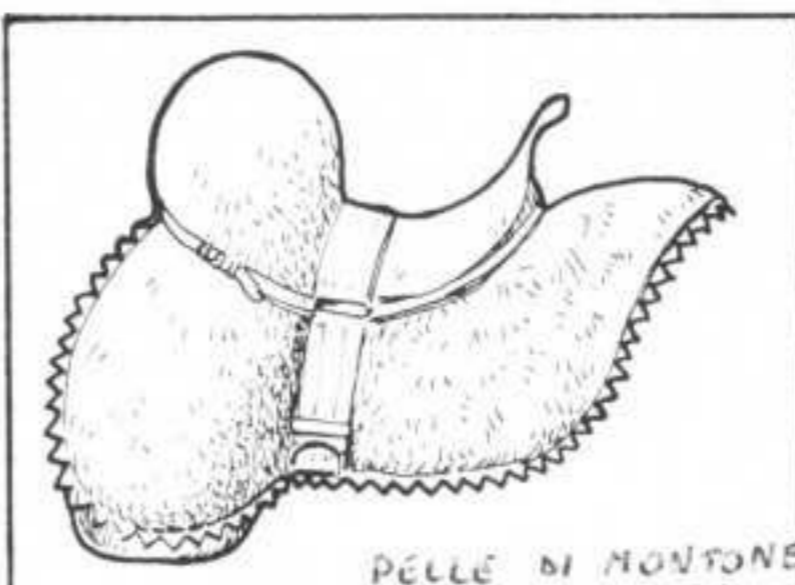

PELLE DI MONTONE

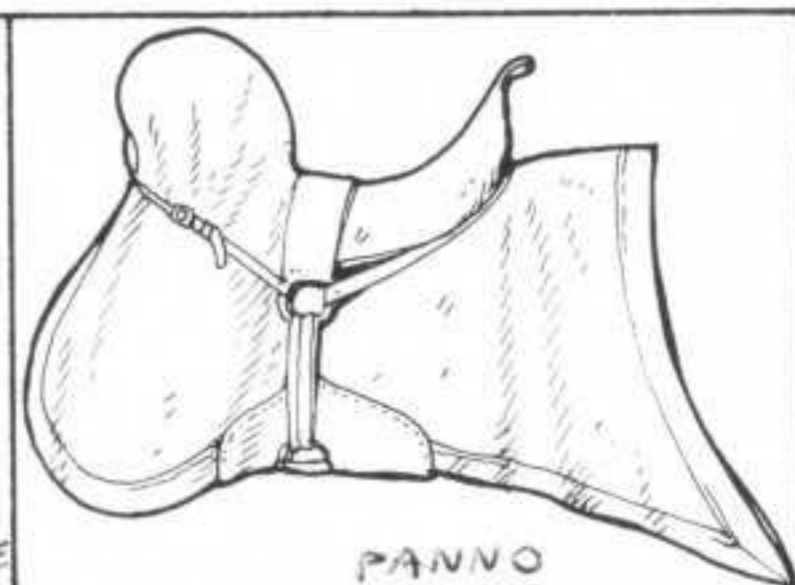

PANNO

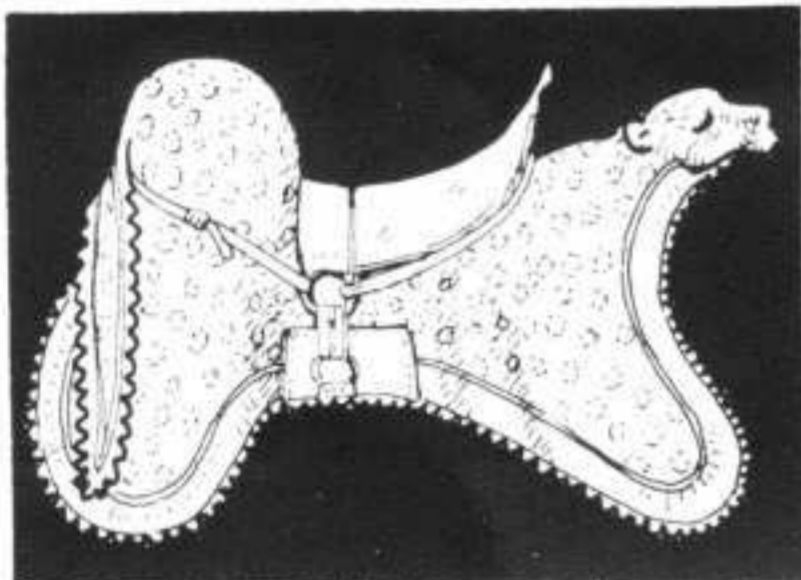

PELLE DI PANZERA

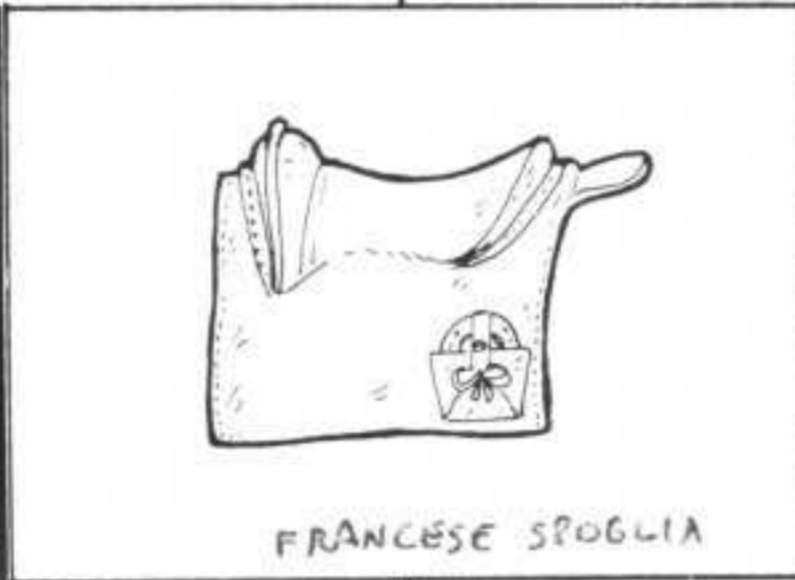

FRANCESE SPOGLIA

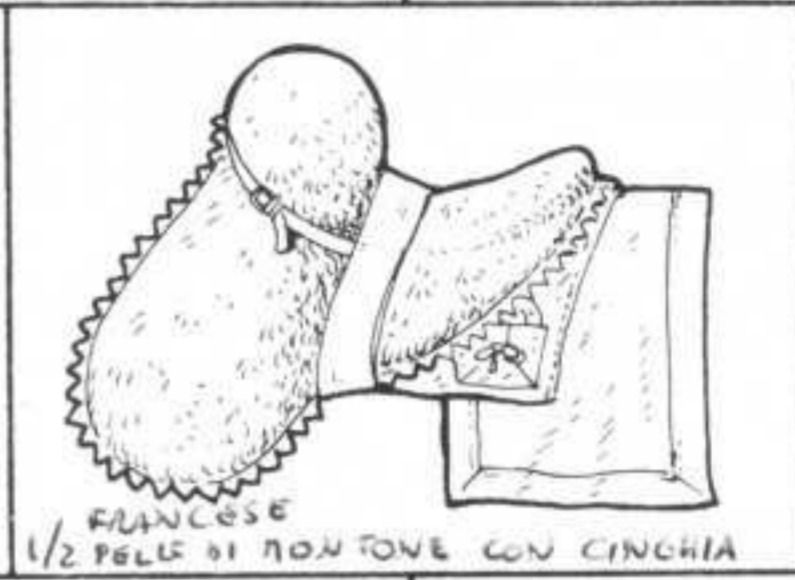

FRANCESE 1/2 PELLE DI MONTONE CON CINGHIA

11  
63  
64

84  
85  
86

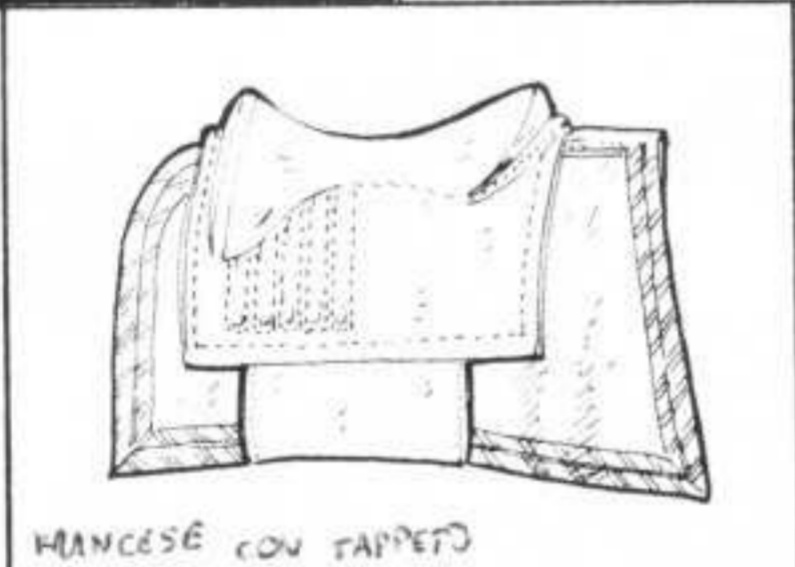

FRANCESE CON TAPPETO

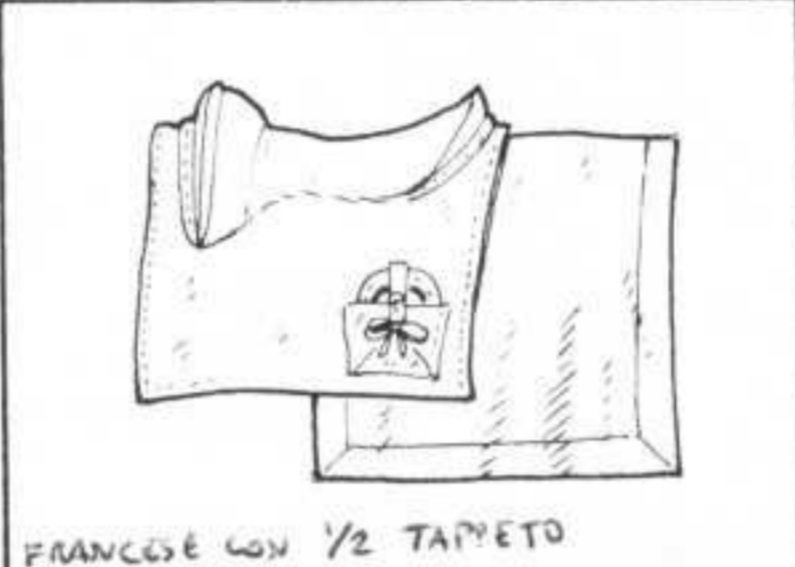

FRANCESE CON 1/2 TAPPETO

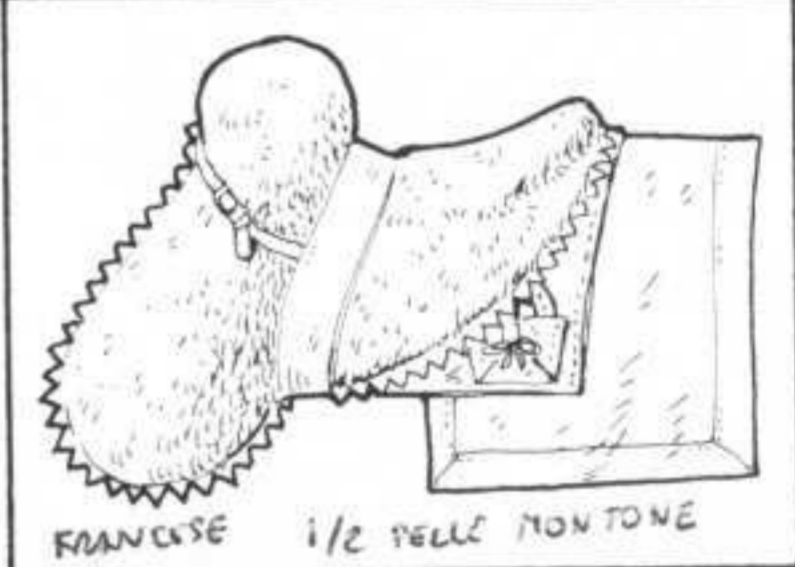

FRANCESE 1/2 PELLE MONTONE

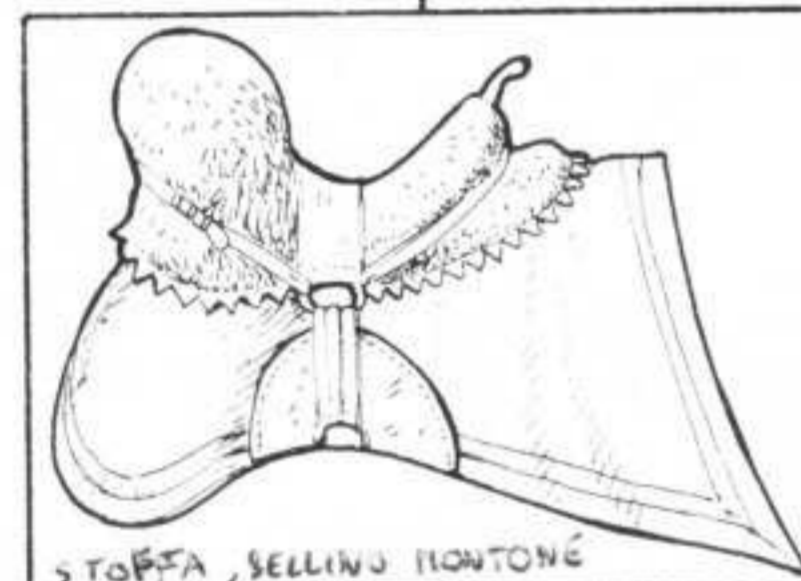

STOFFA, BELLINO MONTONE

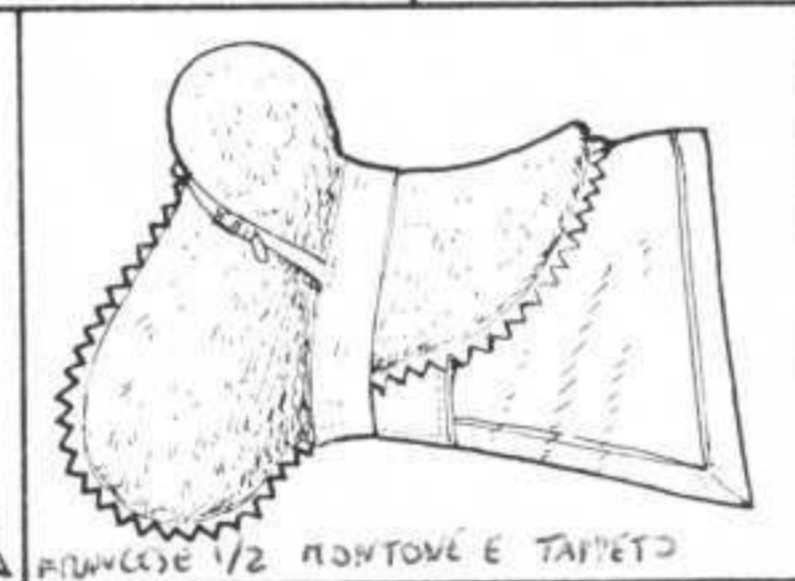

FRANCESE 1/2 MONTONE E TAPPETO



PELLE DI TIGRE

191  
207  
215

232  
383  
368

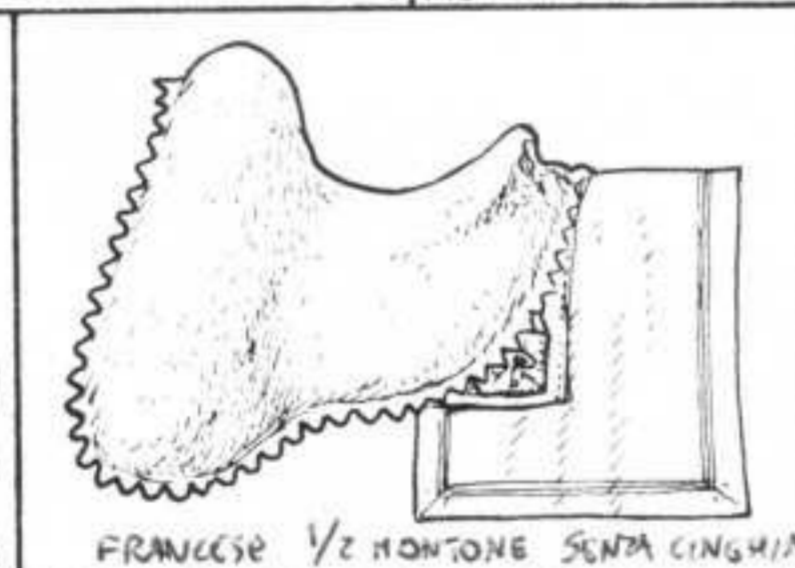

FRANCESE 1/2 MONTONE SENZA CINGHIA



FRANCESE CON COPERTA

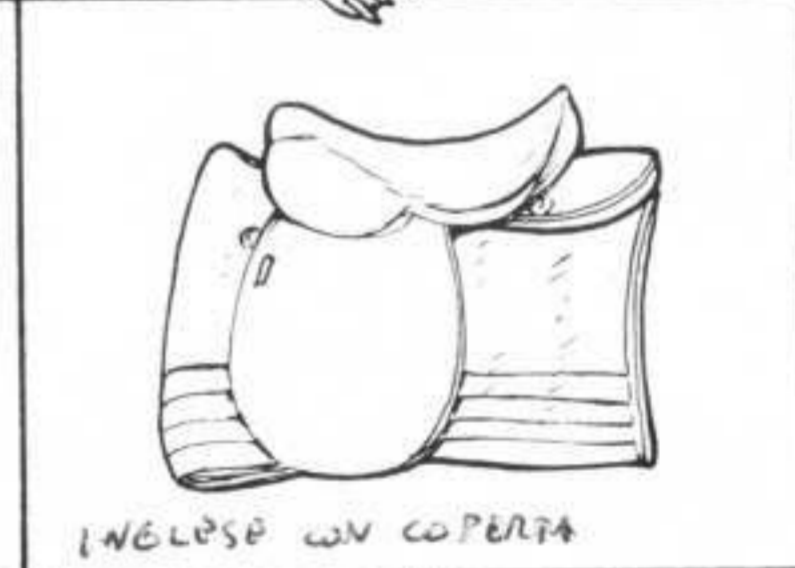

INGLESE CON COPERTA

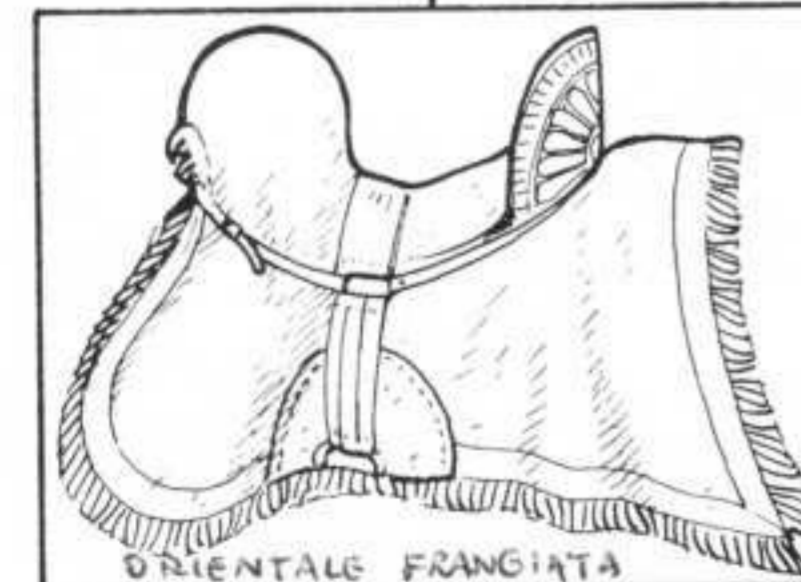

ORIENTALE FRANGIATA

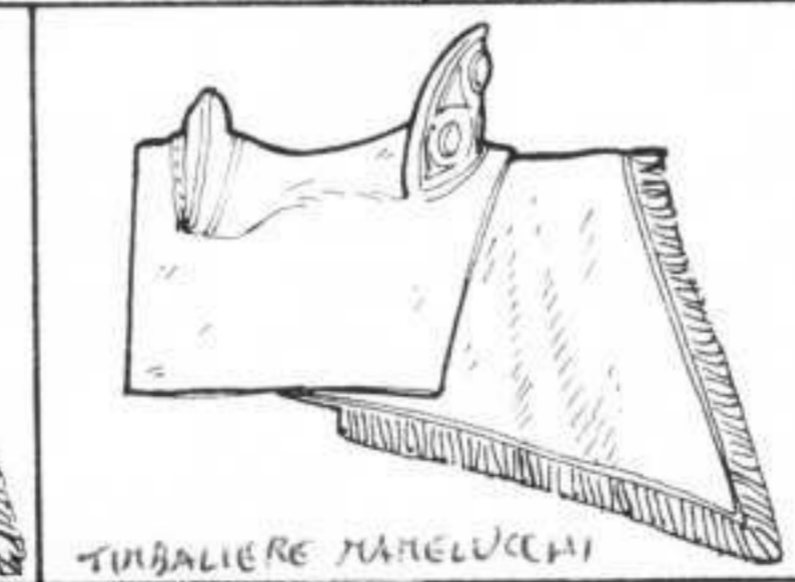

TURBALIERE MARLUCCI

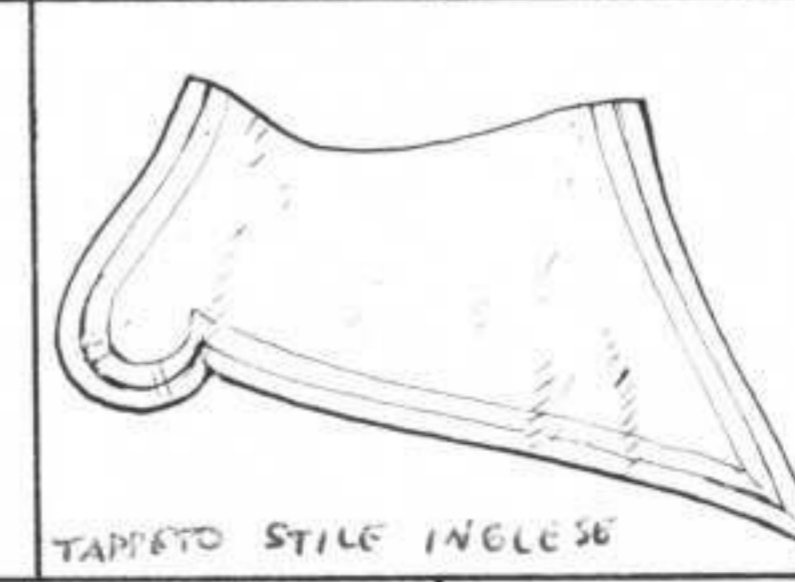

TAPPETO STILE INGLESE

412  
417  
477

478  
516  
NA3

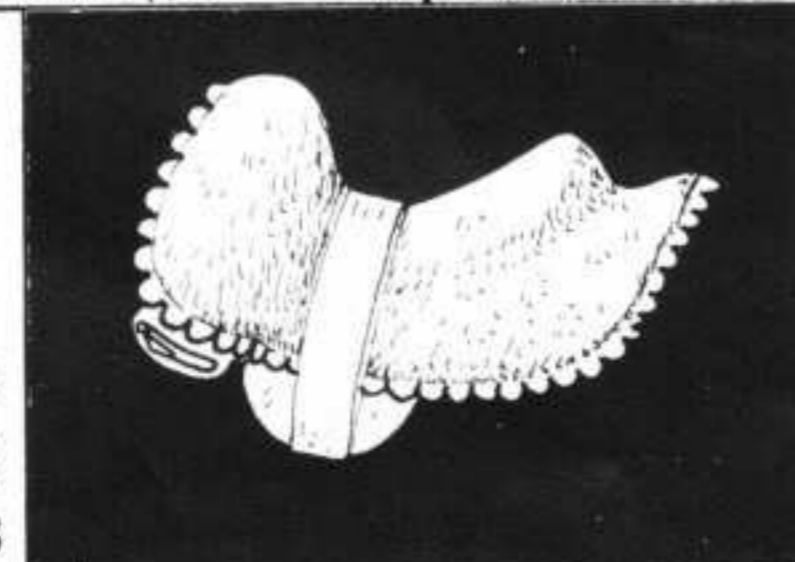

1/2 MONTONE INGLESE

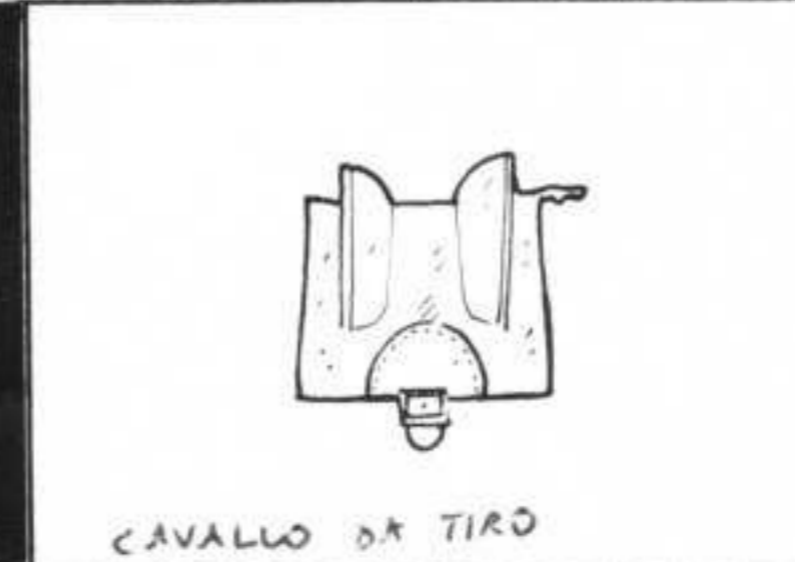

CAVALLO DA TIRO

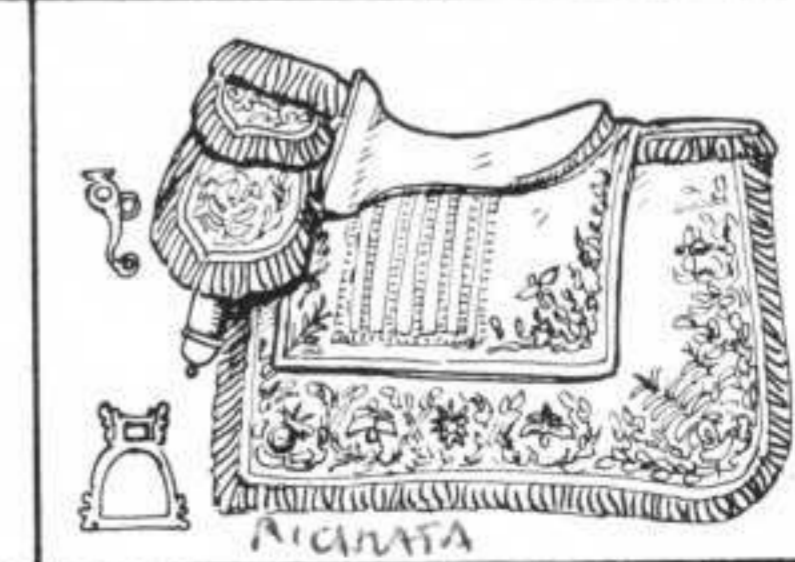

RICAMATA



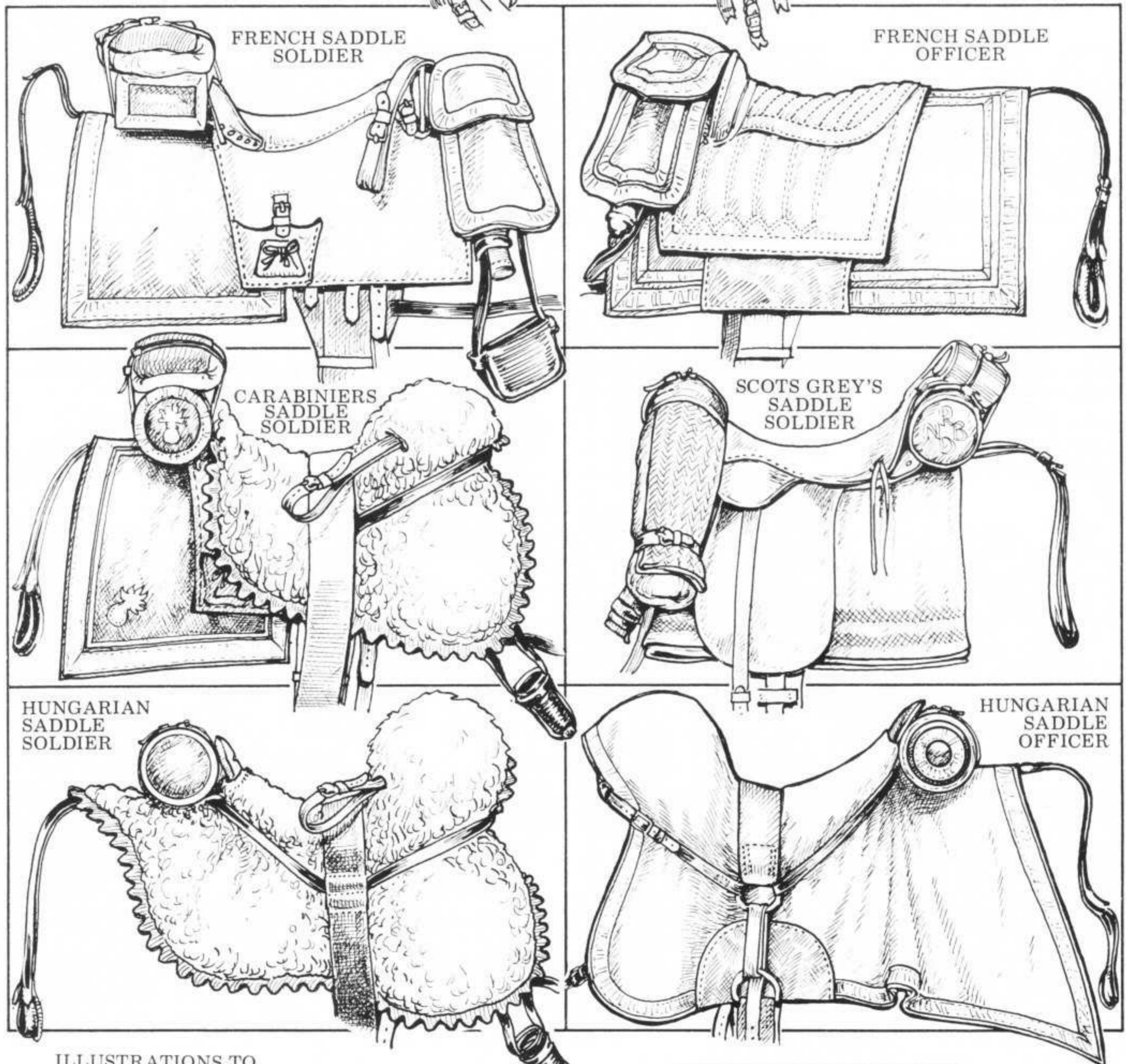
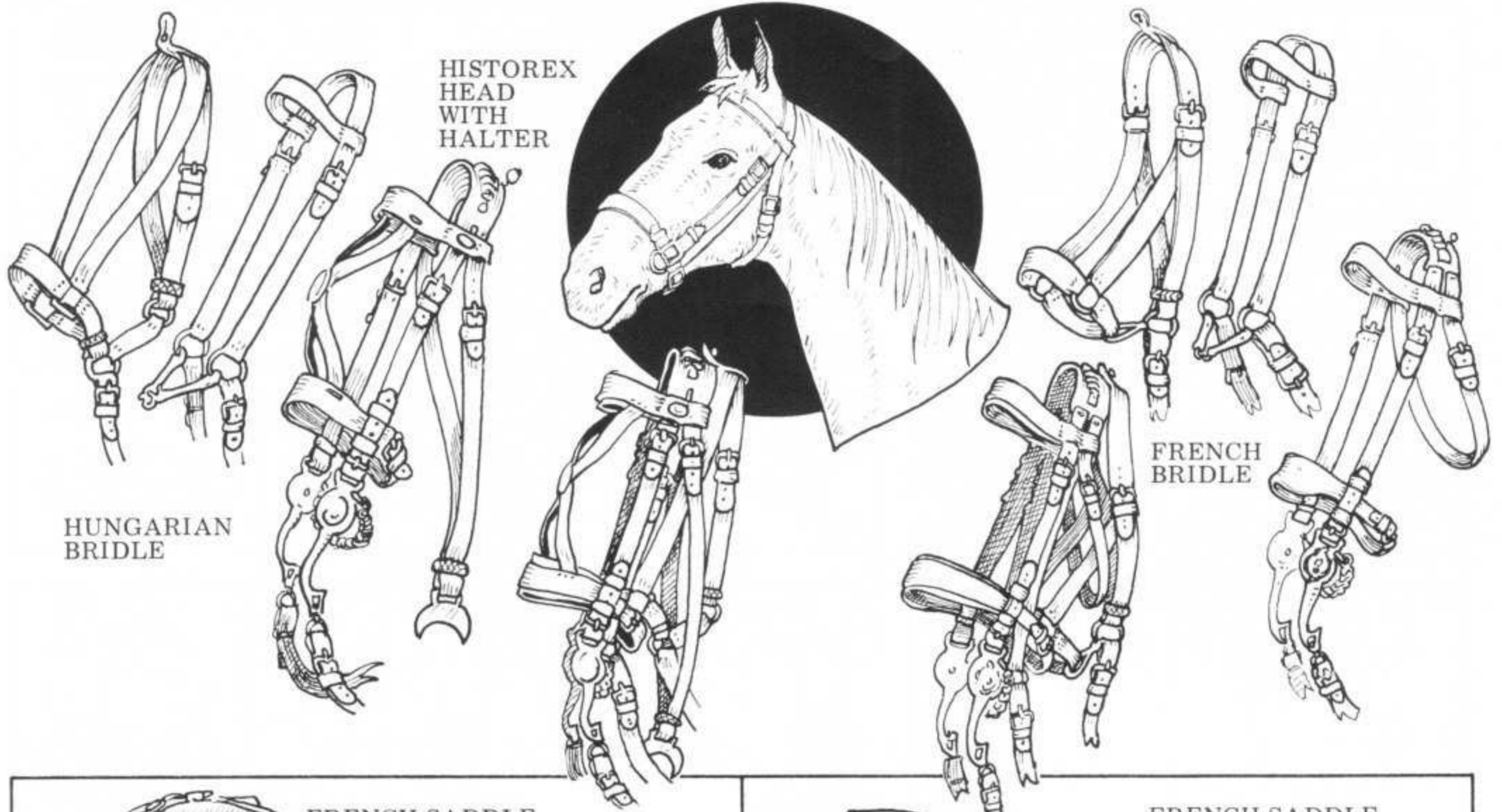







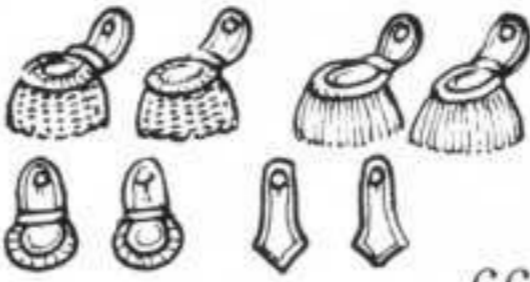

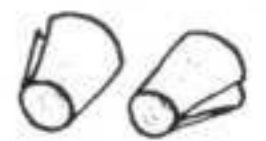
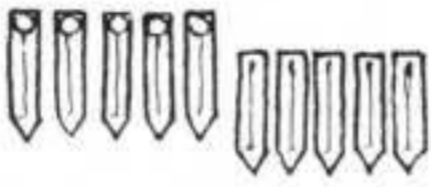

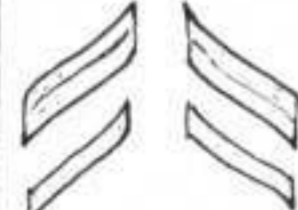

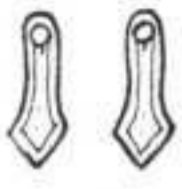

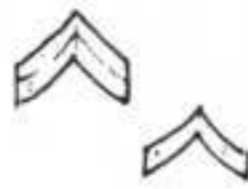
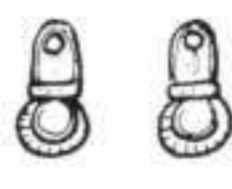



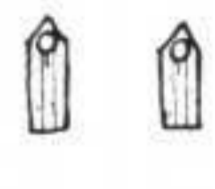
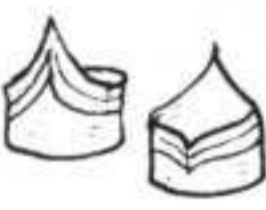



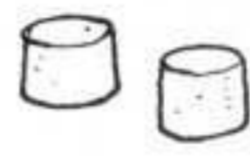
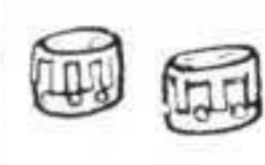
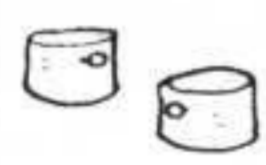
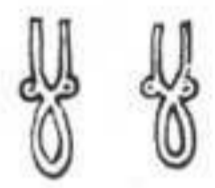
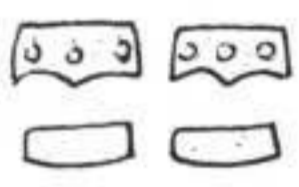

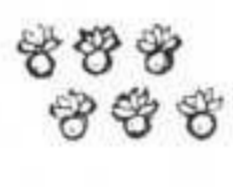

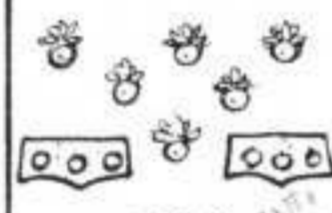

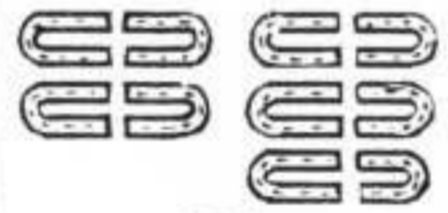

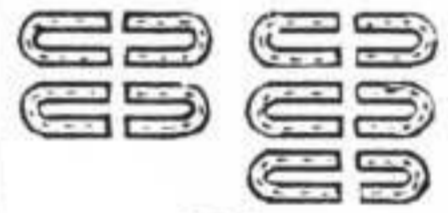







# BRIDLES AND FURNITURE

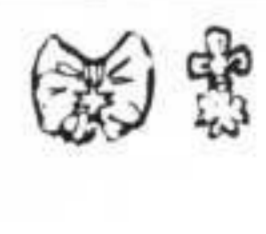
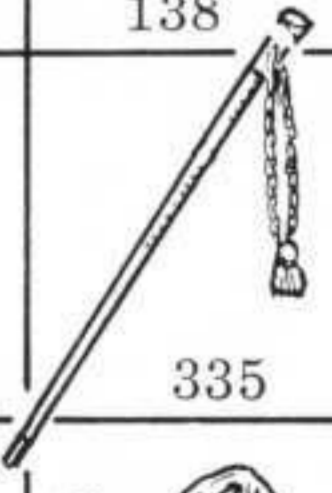

ILLUSTRATIONS TO SHOW HORSE FURNITURE AND SADDLERY ONLY

ILLUSTRATED SPARE PARTS DRAWN BY BRYAN FOSTEN.

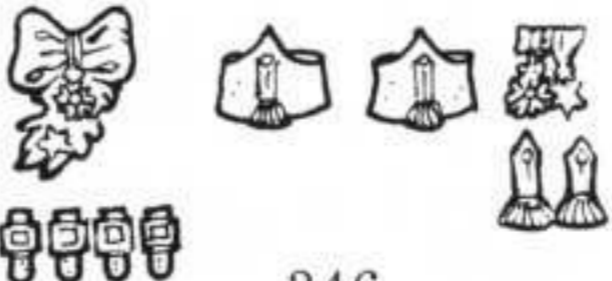
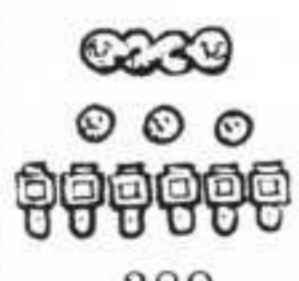
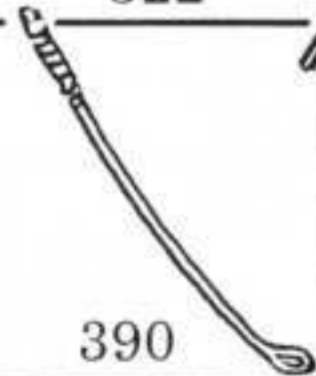
<p><b>HORSE AND SADDLE FURNITURE</b></p>	<p>91</p>	<p>97</p>	<p>103</p>			
<p>131</p>	<p>371</p>	<p>367</p>	<p>414</p>			
<p>70</p>	<p>71</p>	<p>104</p>	<p>146</p>	<p>193</p>		
<p>326</p>	<p>369</p>	<p>384</p>	<p>427</p>	<p>453</p>	<p>484</p>	
<p>50</p>	<p>54</p>	<p>75</p>	<p>76</p>	<p>224</p>	<p>244</p>	<p>425</p>
<p>57</p>	<p>Regimental numbers for Saddle Cloth and portmanteau 0123456789 in two sizes</p> <p>98</p>		<p>141</p>	<p>168</p>		
<p>Regimental numbers for Saddlecloth 0123456789</p> <p>206</p>	<p>323</p>	<p>328</p>	<p>330</p>	<p>334</p>	<p>401</p>	
<p>413</p>		<p>415</p>		<p>426</p>		
<p>428</p>			<p>435</p>	<p>442</p>	<p>480</p>	
<p>40</p>	<p>123</p>	<p>186</p>	<p>210</p>		<p>546</p>	

<b>INSIGNIA</b>		 44		 66		 79		 81							
		 99		 122		 233		 234		 235					
 254		 255		 257		 302		 338		 339		 357		 358	
 359		 406		 452		 455		 495		 535		 543		 553	
 558		 559				 109		 142		Regimental numbers for turnbacks 1 - 0 two of each 230					
 231				 269		 325		 332							
<b>EXAMPLES OF INSIGNIA SPRUES</b>		Left 127 Right 145				 325		 332		 0 - 9 in two sizes					
<b>MISCELLANEOUS MARSHALS INSIGNIA</b>				 118		 120		 134		 135		 138			
 187		 208		 209		 216		 247		 322		 335			
 341		 342		 344		 346		 389		 390		 393			

MUSICAL INSTRUMENTS



60



248



250

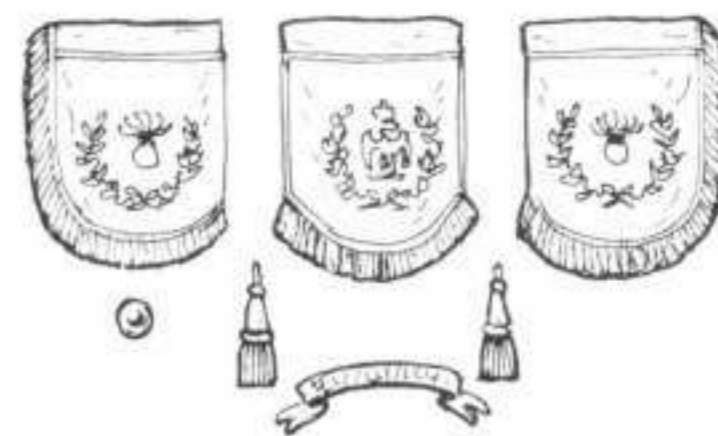

251



268



271

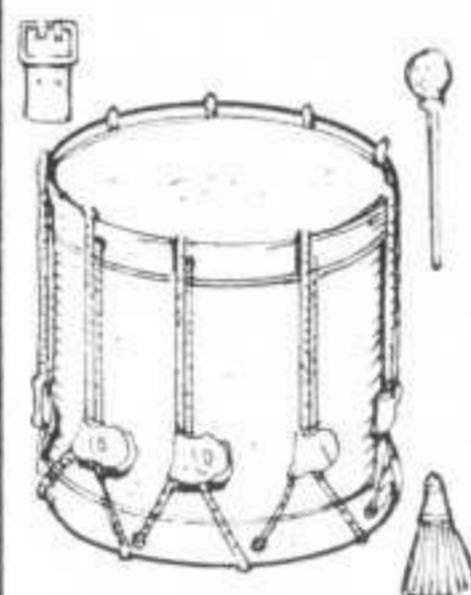

274

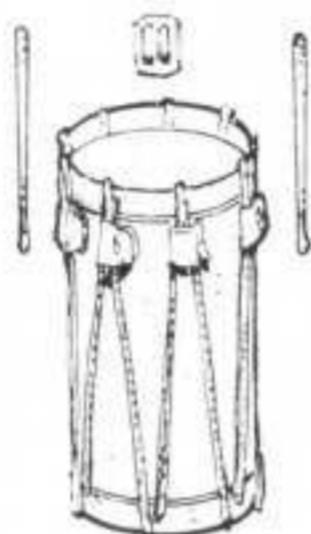

275

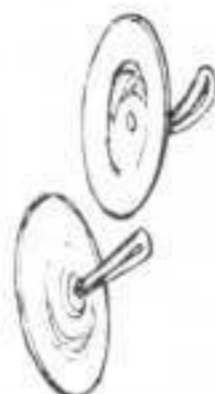

276



277



278



279



280



281



282

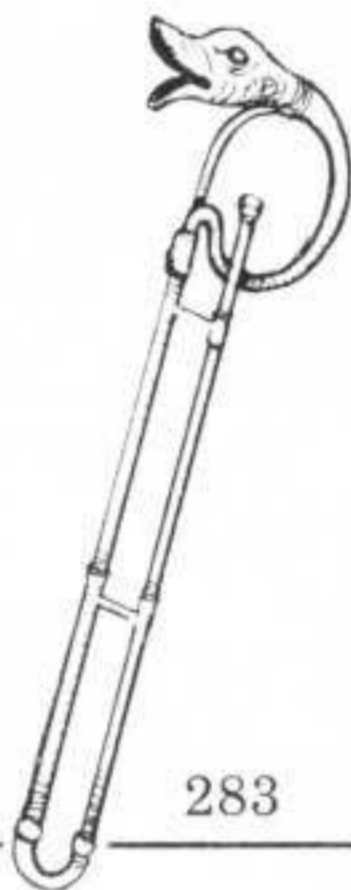

283

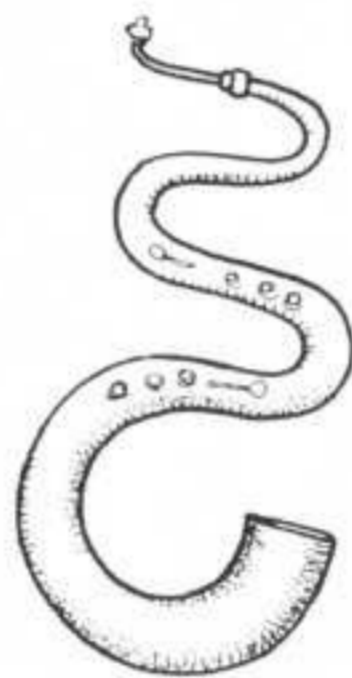

284

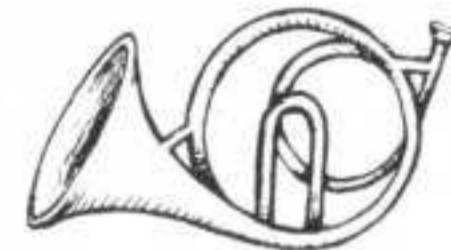

285



418



420

16



61



82



181

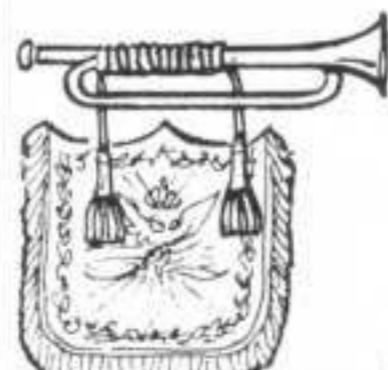

184



188

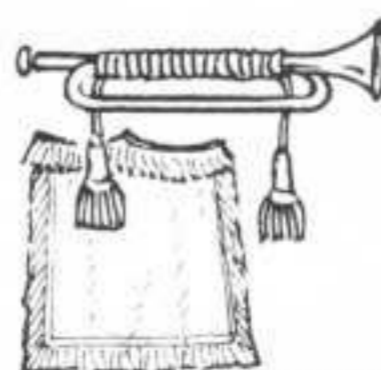

337



370



**POUCHES PACKS  
AND PENNANTS**

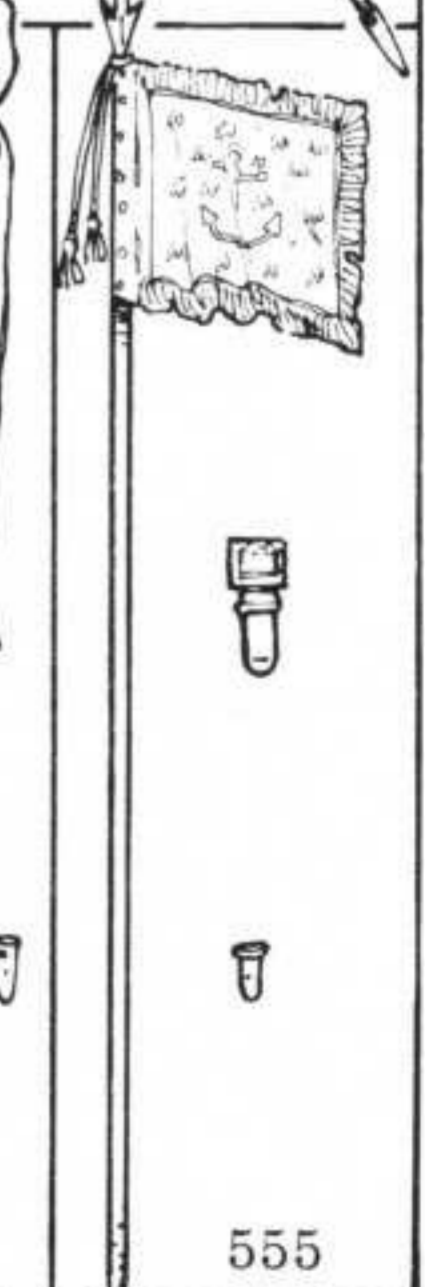
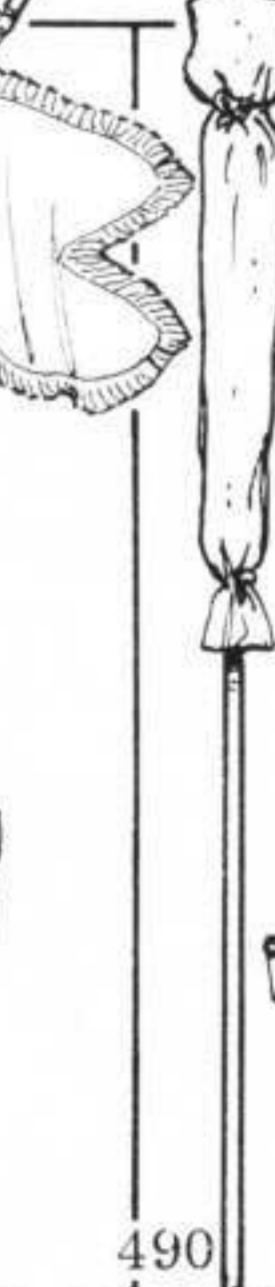
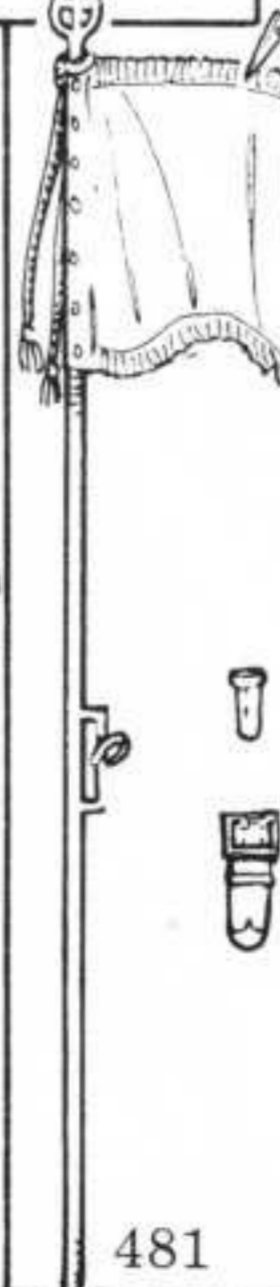
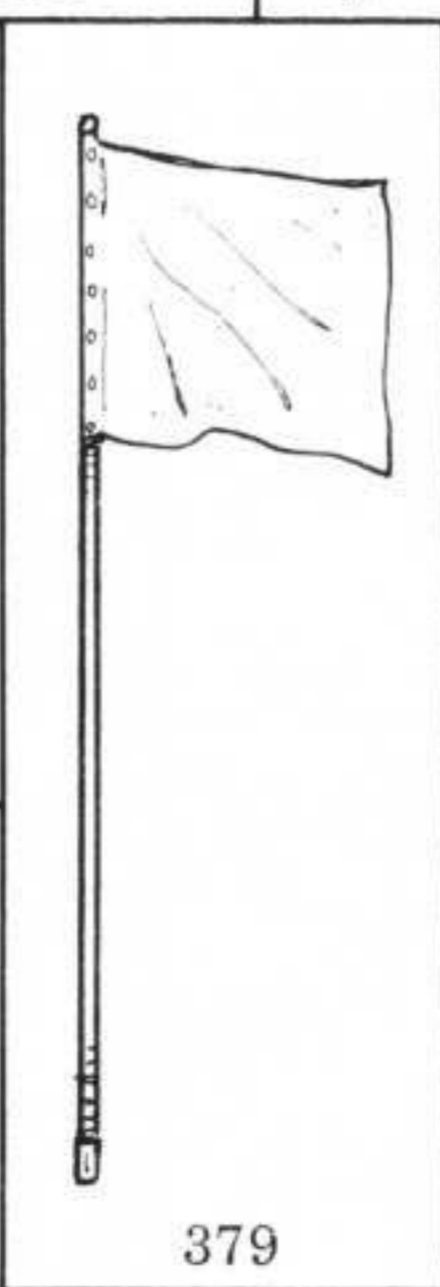
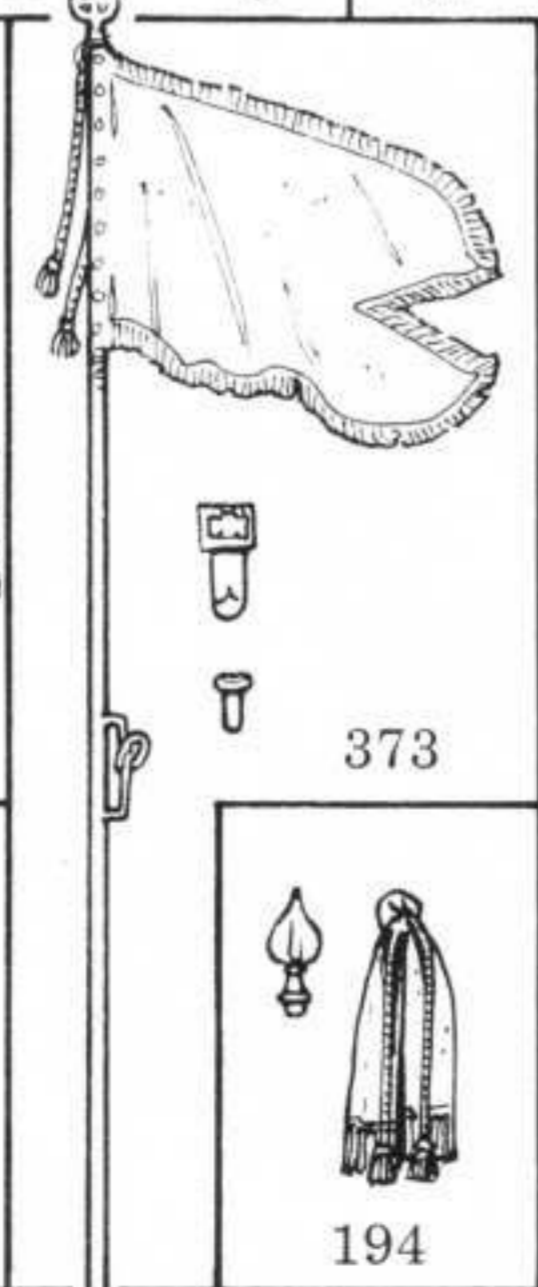
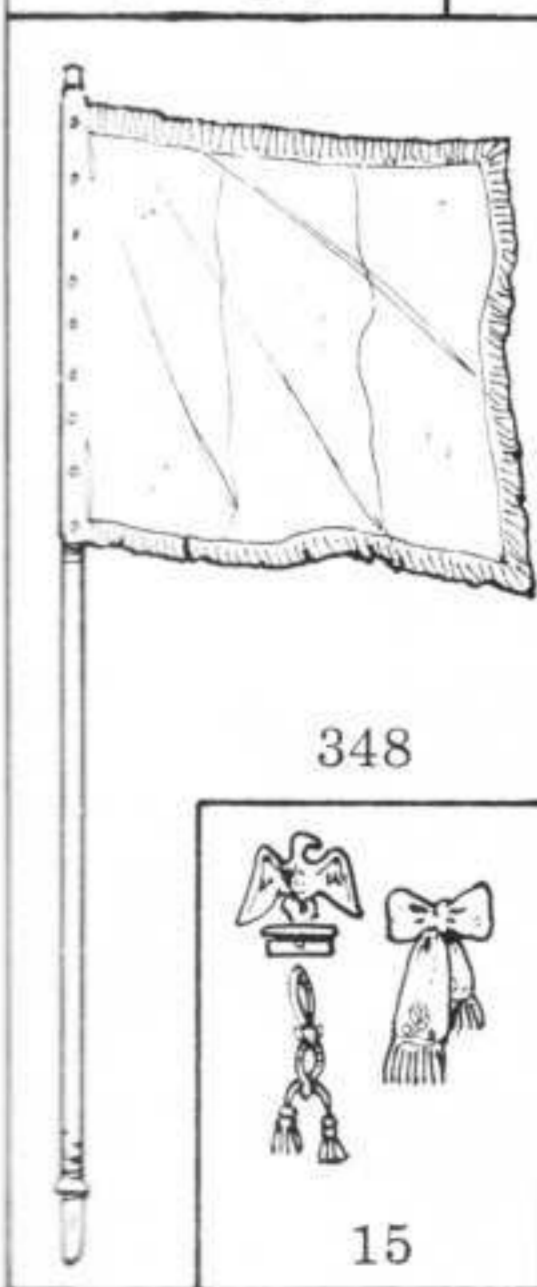
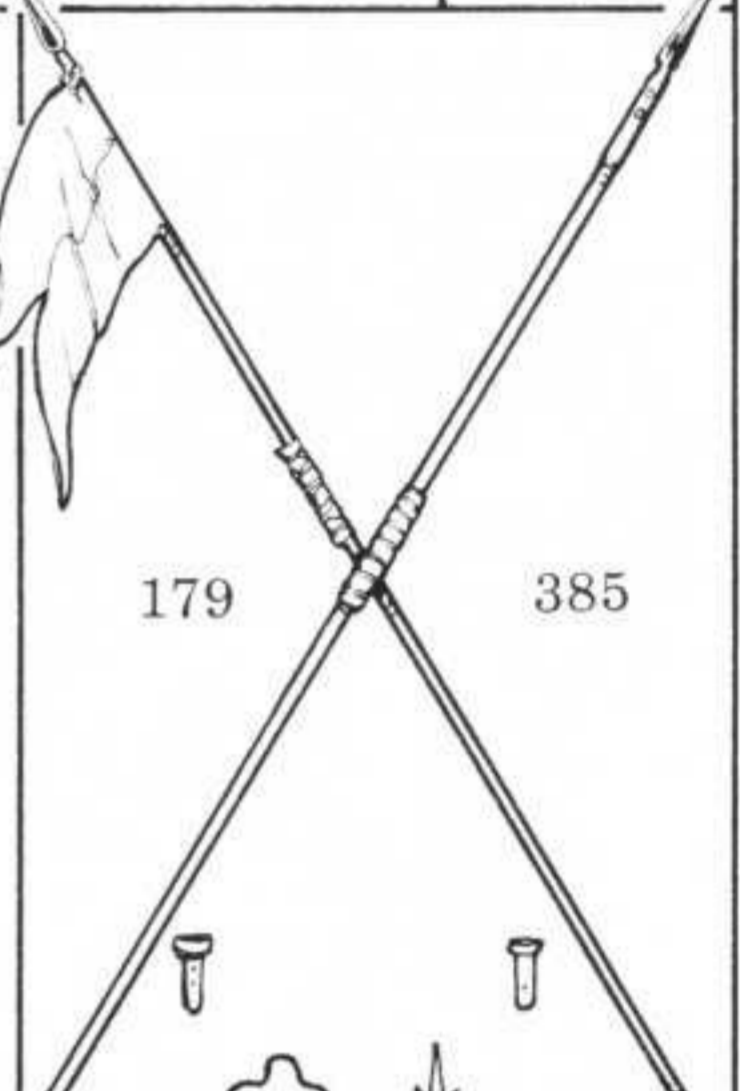
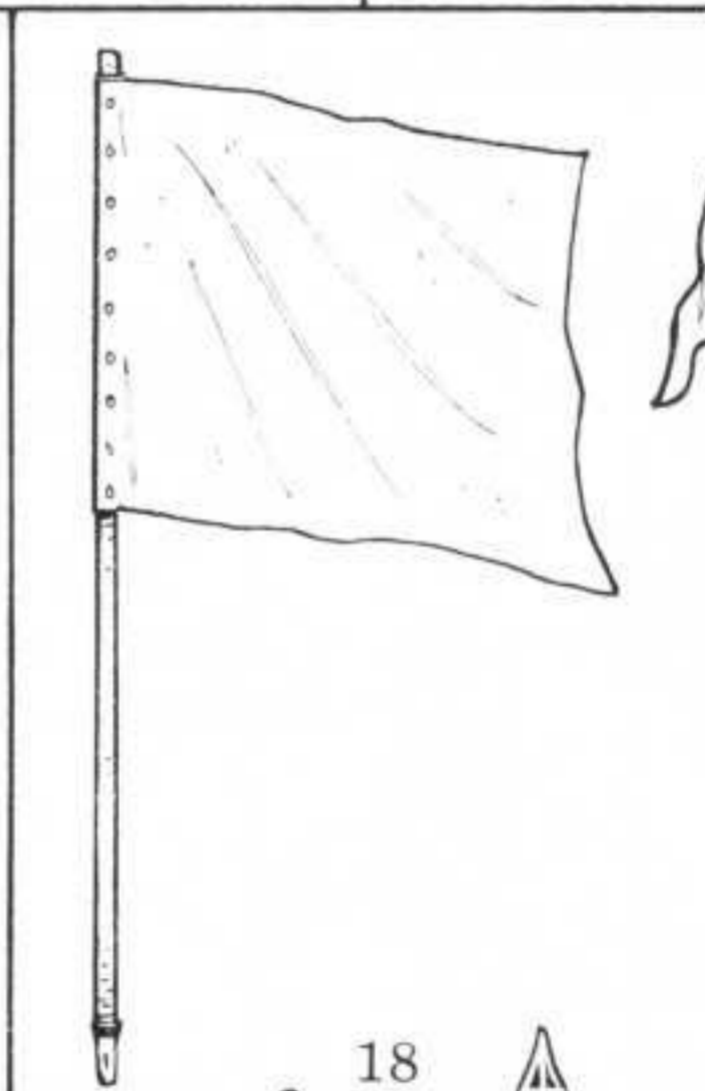
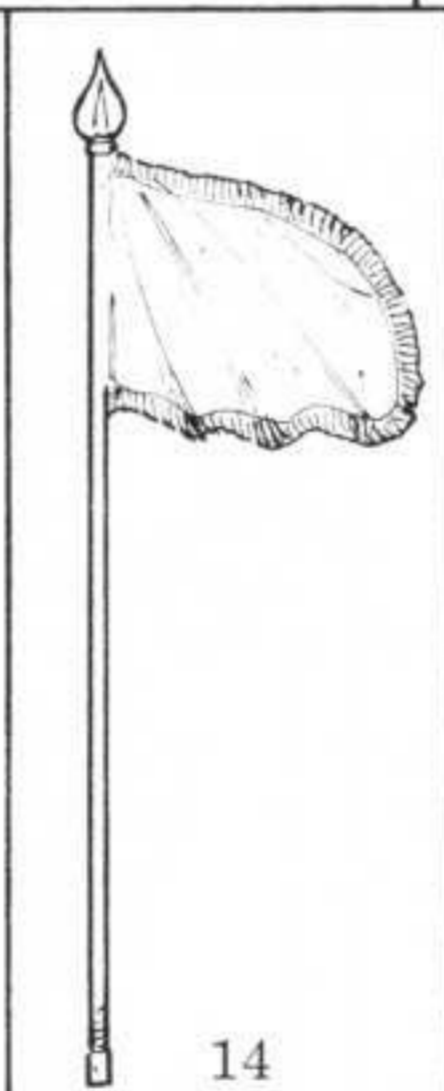
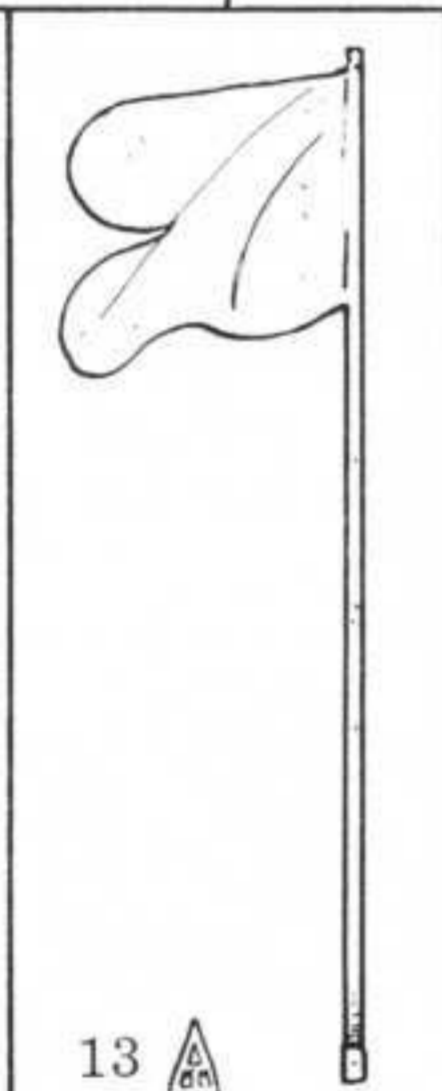
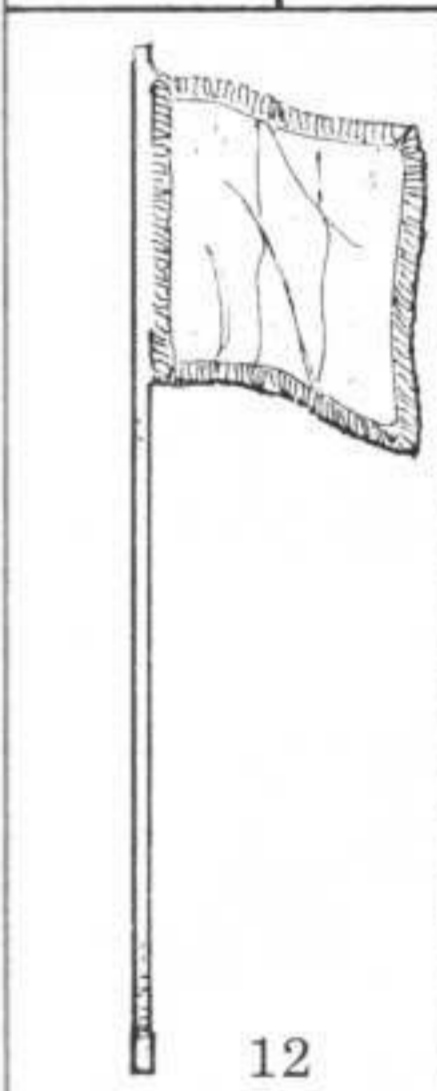
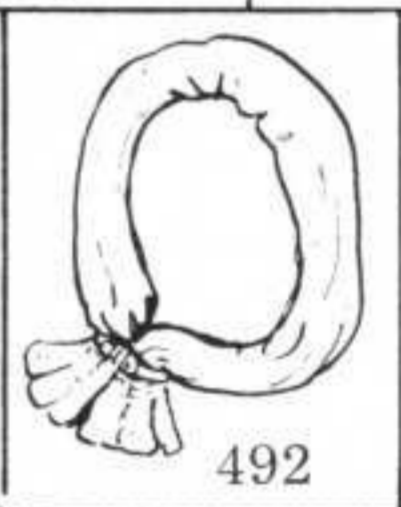
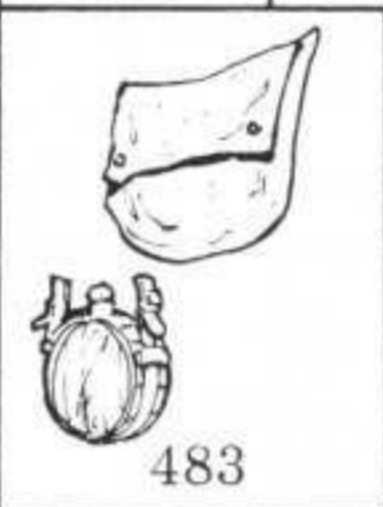
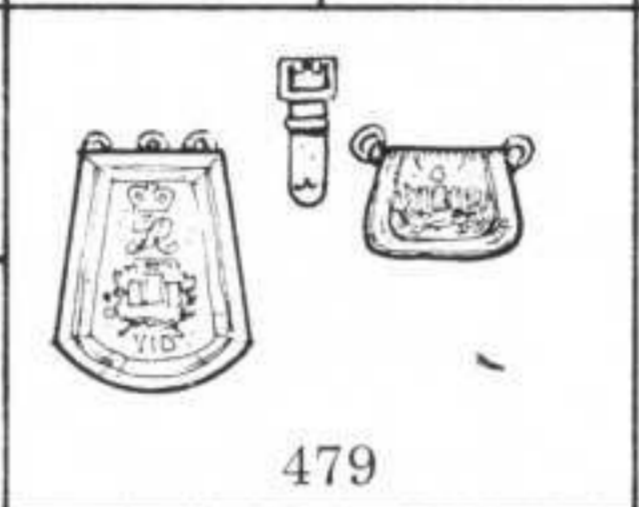
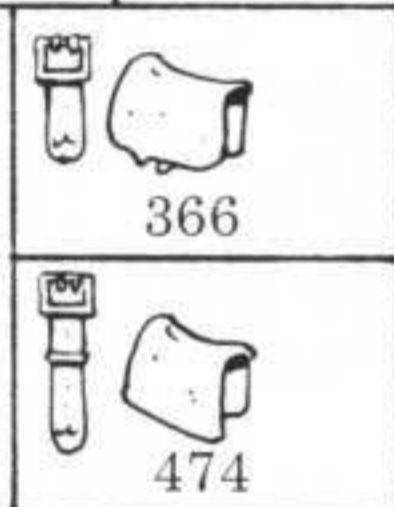
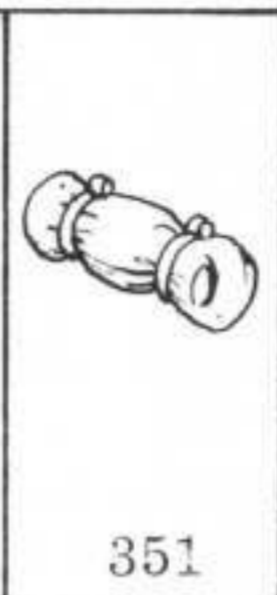
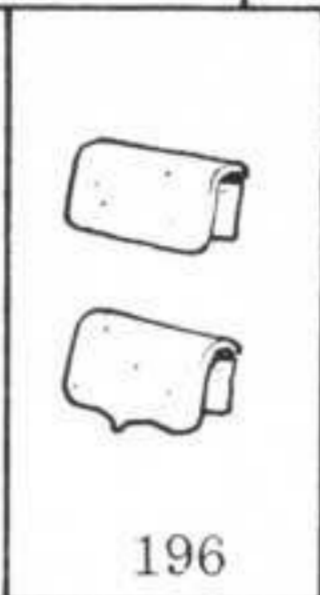
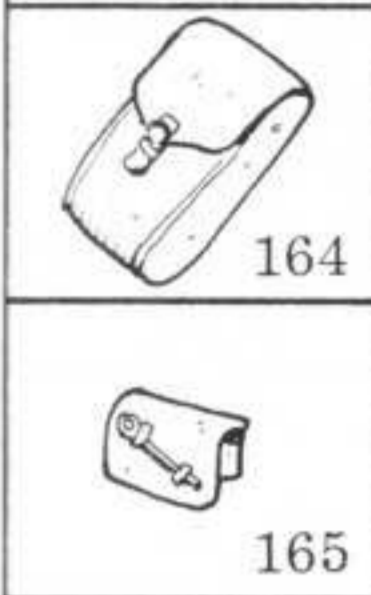
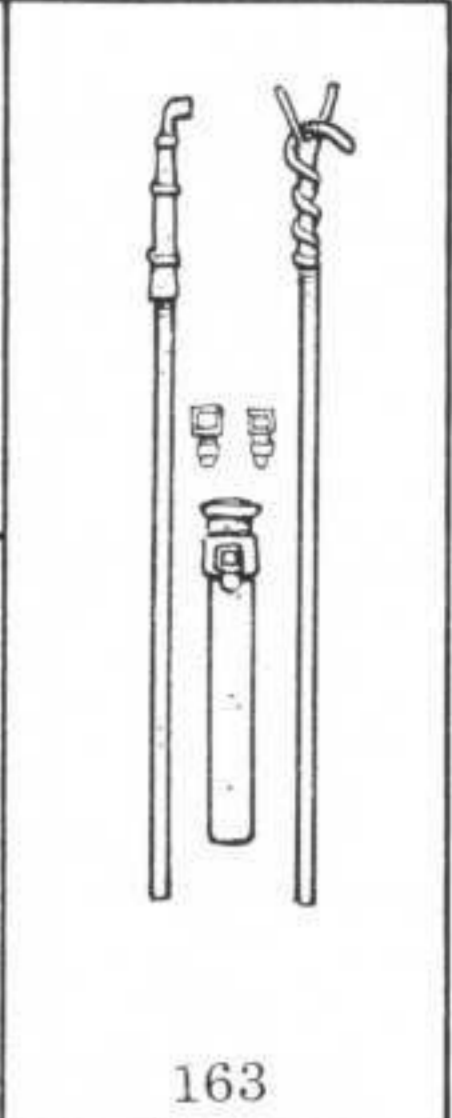
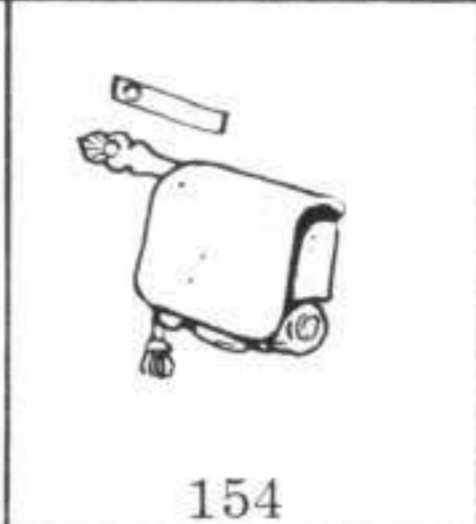
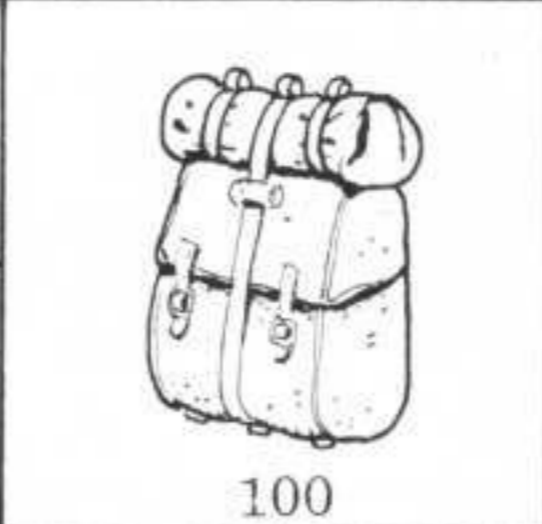

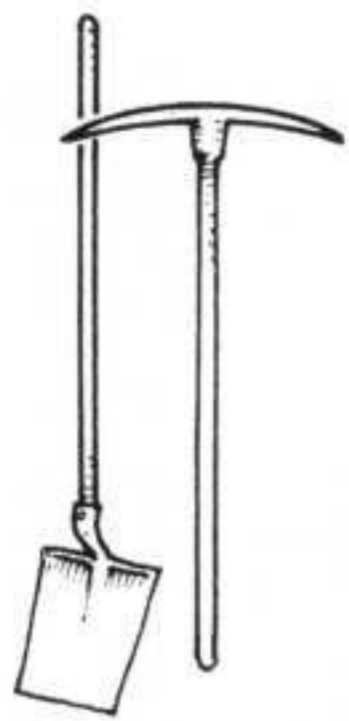

508



510

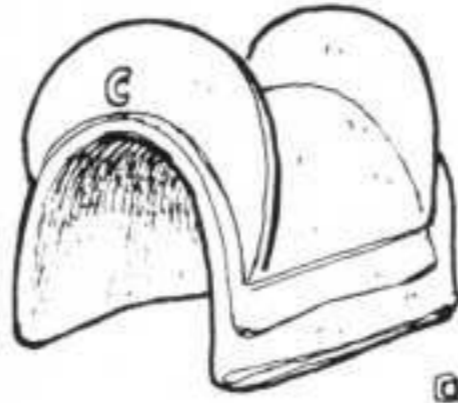

513



514

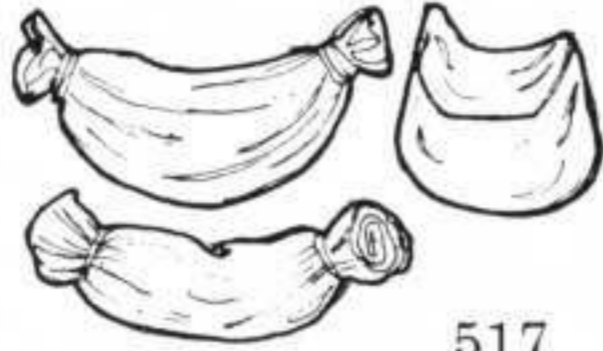

517



518



519



520



521



537

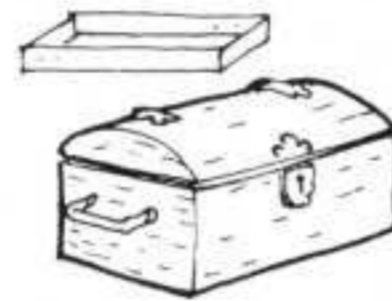

540

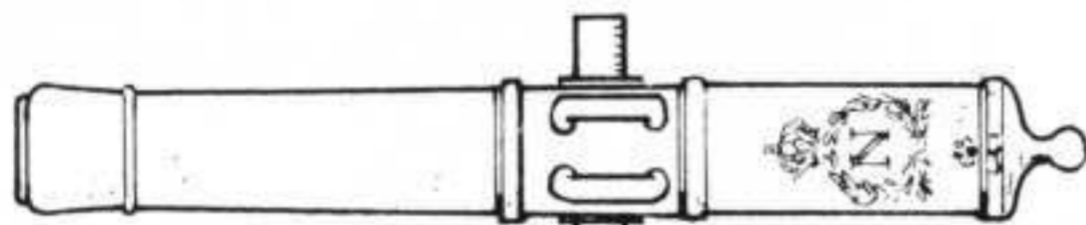

CANNON BARREL

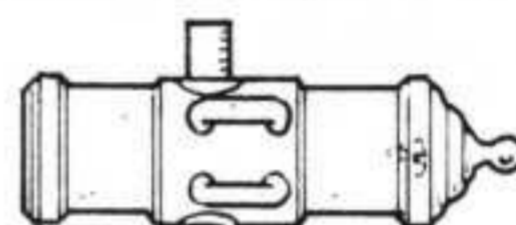

HOWITZER BARREL

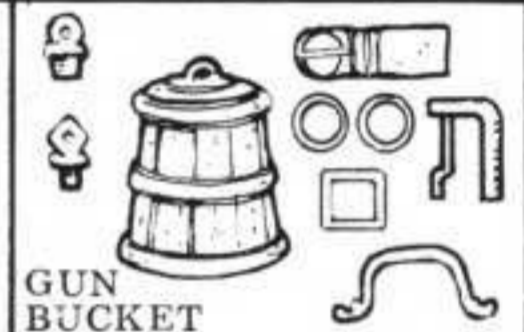

GUN BUCKET

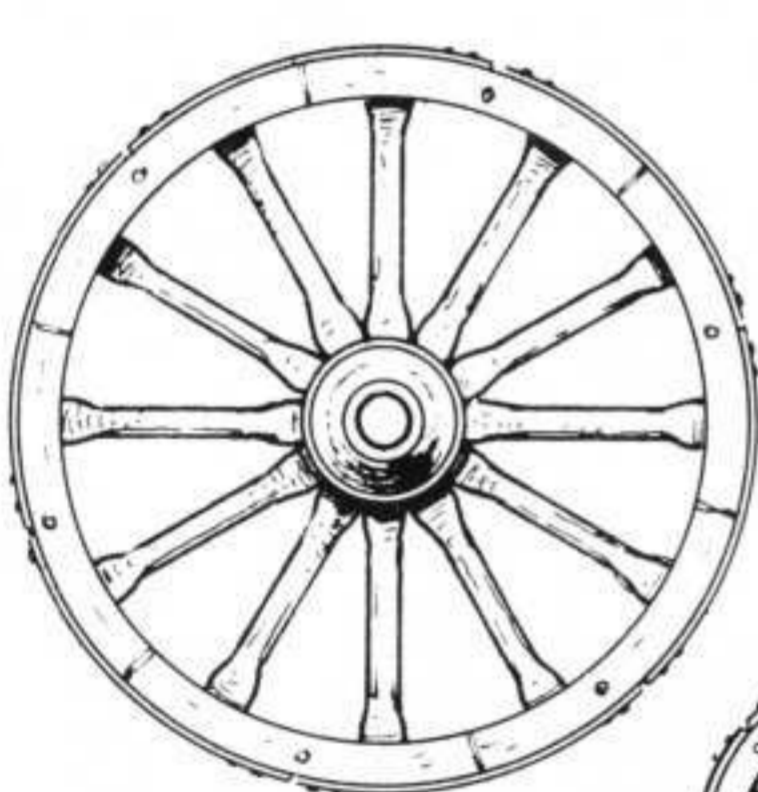

GUN WHEEL

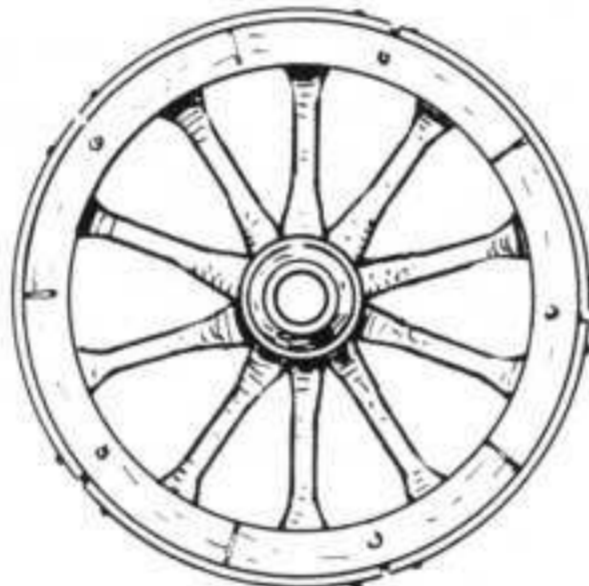

LIMBER WHEEL

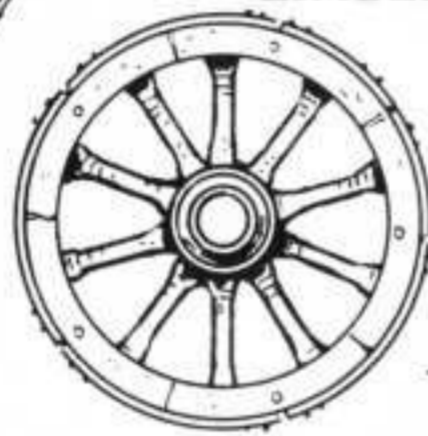

AMBULANCE WHEEL

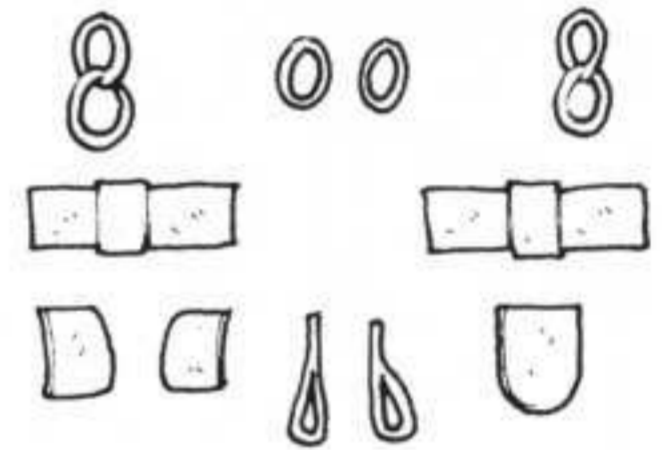
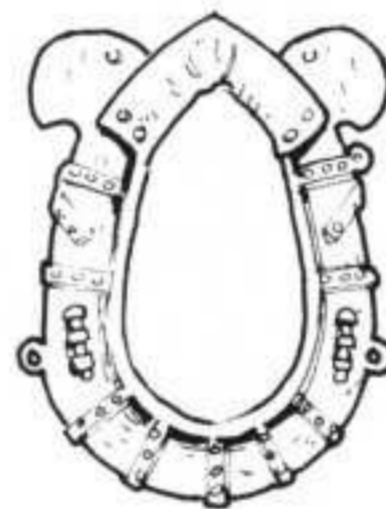

REAR DRIVER HORSE

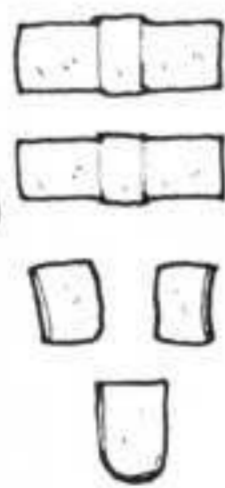
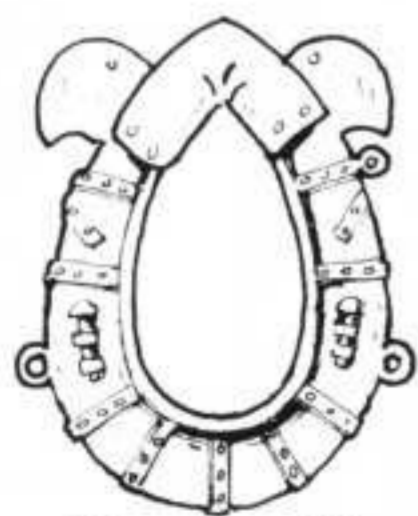



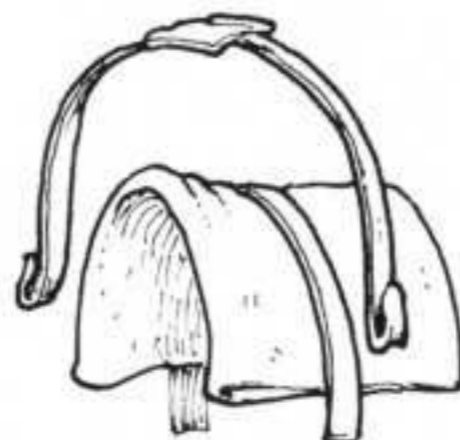
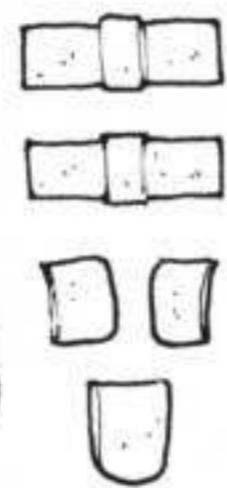
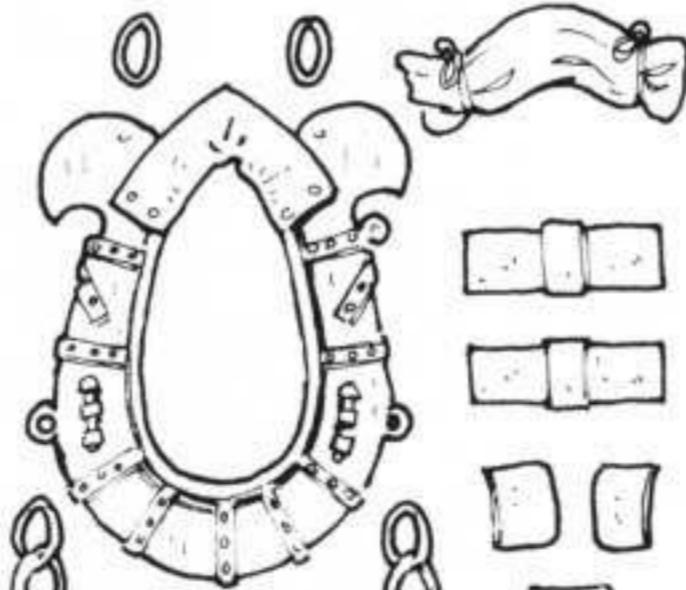



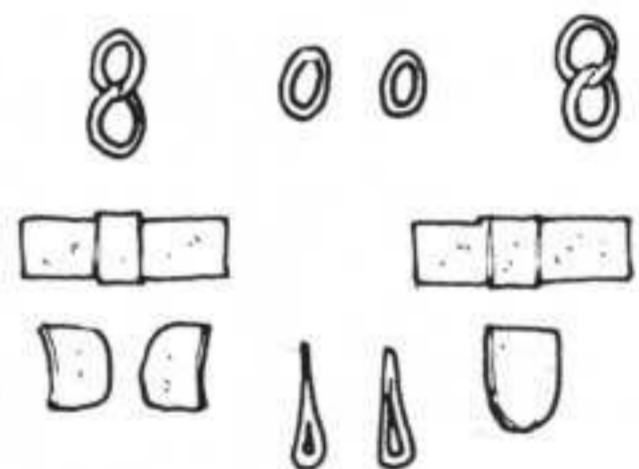
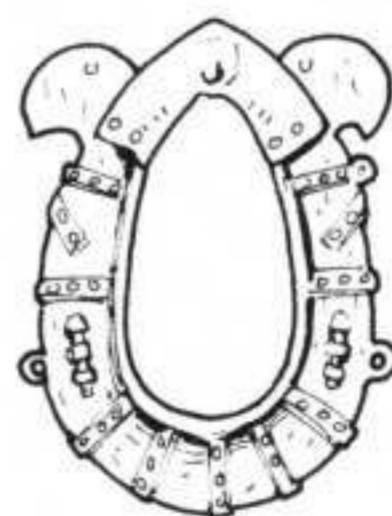



































LEAD DRIVER HORSE



LEAD OFF HORSE

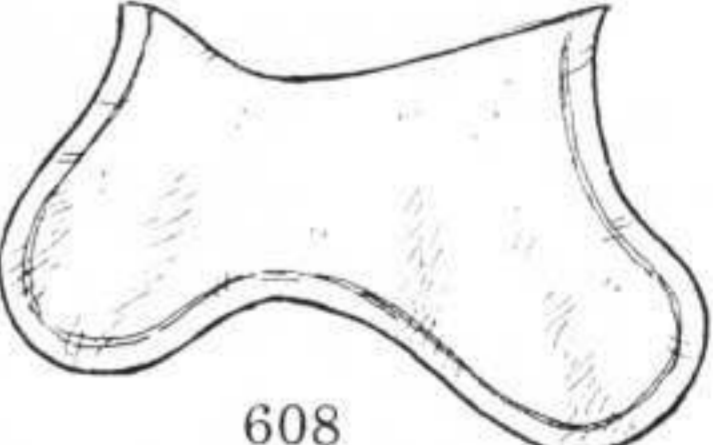
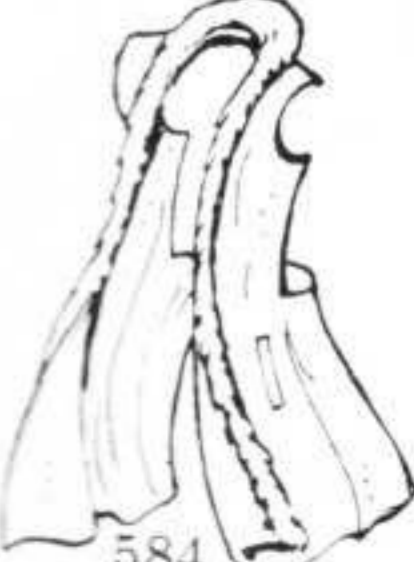

REAR OFF HORSE

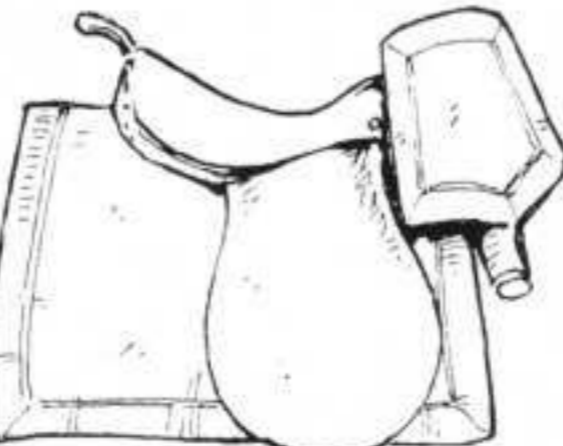
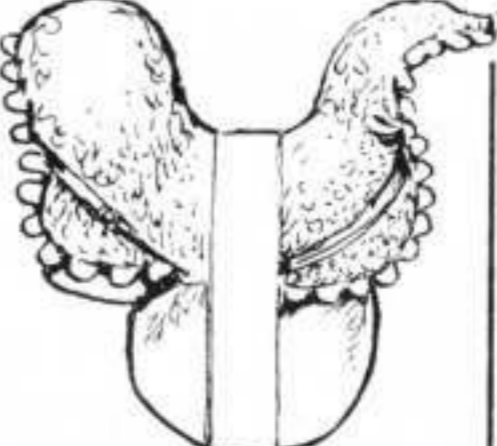
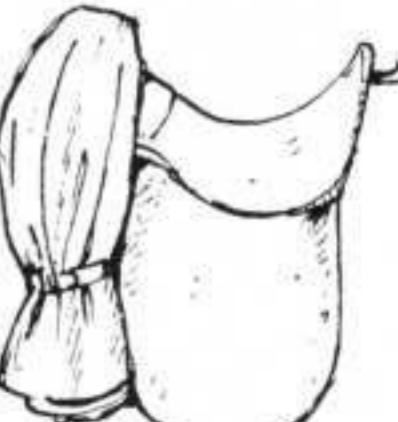
 396 NAPOLEON	 139 DAVOUT	 137 SOULT	 136 BESSIERES	 140 MORTIER	 133 BERTHIER	 211 MURAT
 180 PONIATOWSKI	 198 HAUTPOUL	 532 LARREY	 320 LAUZAN	197  GOUVION SAINT-CYR	 582 NEY	 572 LASALLE
 37	 41	 68	 119	 124	 143	 147
 151	 190	 256	 260	 270	 305	 317
 324	 329	 404	 416	 ROUSTAN 423	 471	 502
 588	 591	 617 BEAUHARNAIS	 619 LANNES	 629 CONSTANT	 608	
 584	 585	 630	 614	 609	 625	

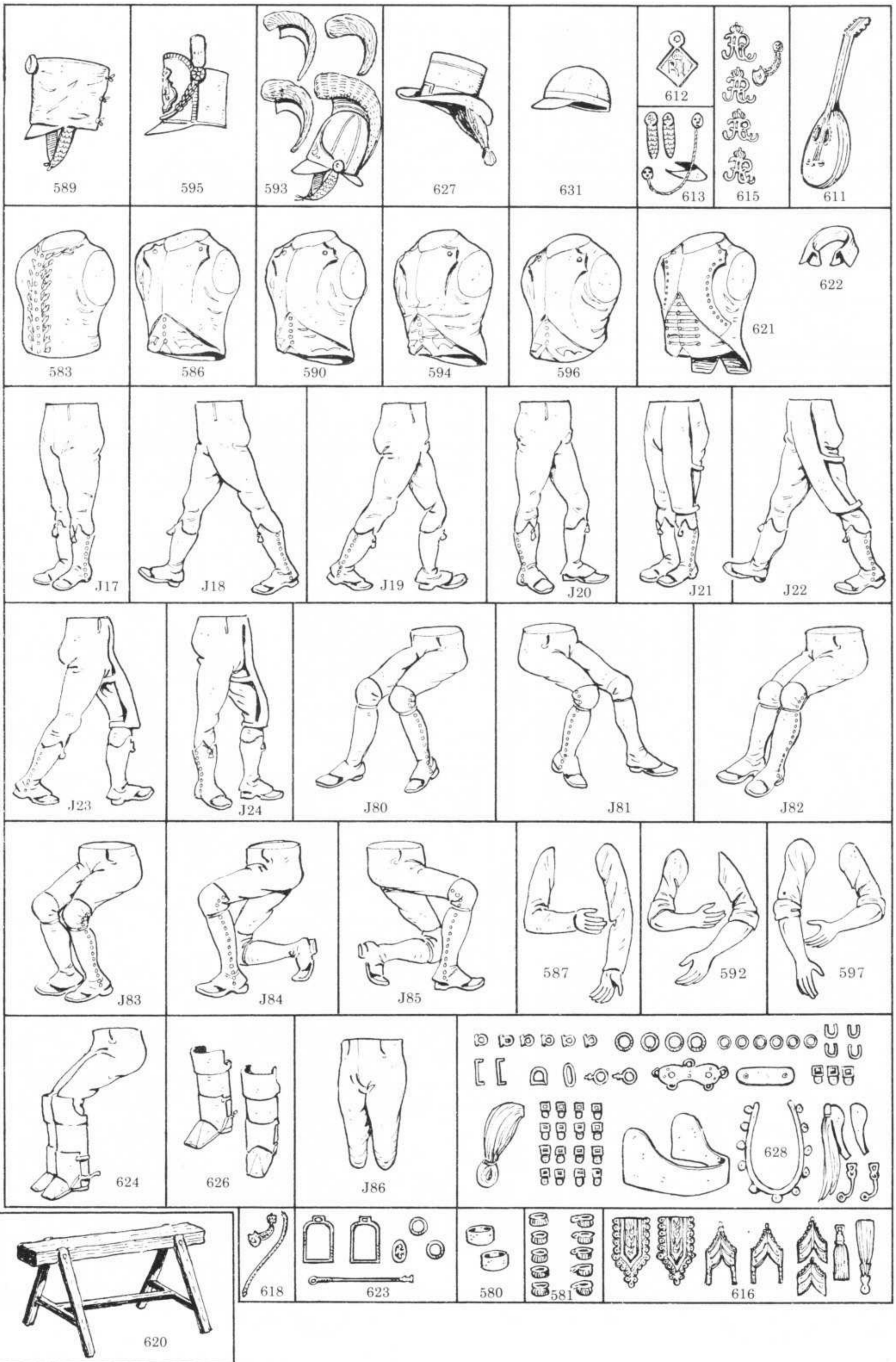

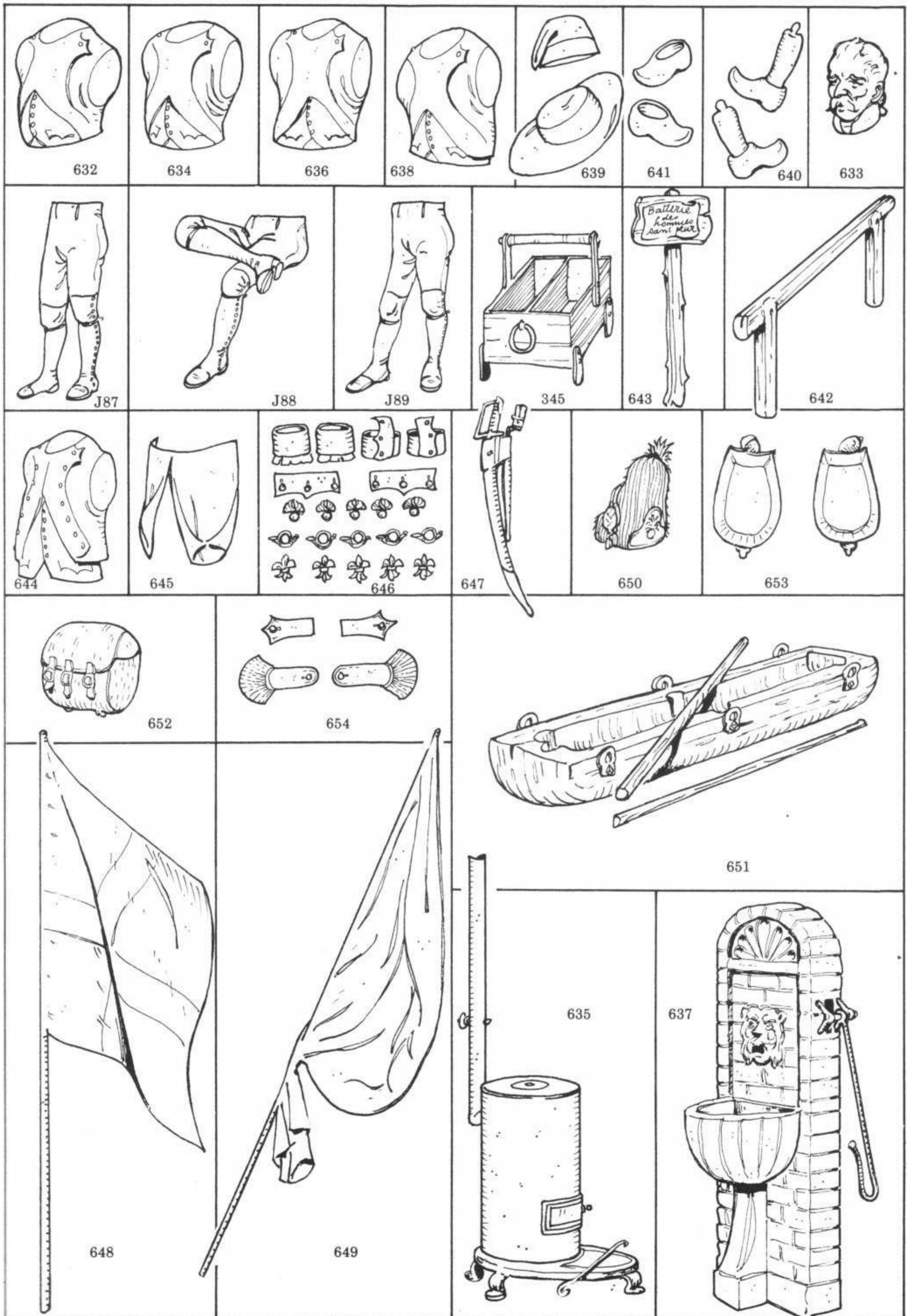



**HISTOREX**  
AGENTS

STOCKIST

--

OUR ILLUSTRATED COLOUR CATALOGUE/HANDBOOK  
IS ON SALE AT YOUR LOCAL MODEL SHOP  
OR DIRECT FROM  
HISTOREX AGENTS, 3 CASTLE STREET, DOVER