





GF  
119

VII-945



BIBLIOTECA  
CENTRAL MILITAR

Inscripción .. { Folio.....  
                  { Número.....

Clasificación. { División....  
                  { Subdivisión

Colocación .. { Estante...  
                  { Tabla...  
                  { Número... 380

I-584



V-62-12-18

CB. 968049J



COLECCIÓN DE LÁMINAS

# DEL MATERIAL

DE LA

## ARTILLERÍA ESPAÑOLA

TOMO VI ]

MADRID.=1884-1888

(s. i.)



# INDICE

del tomo 6.º de la Colección de láminas del material de artillería española. Comprende 55 láminas cromo-litográficas, publicadas desde Julio de 1884 hasta fin de 1888.

## SERIE A.

*Piezas de artillería, proyectiles, municiones y alzas.*

- Lámina 51. Cañón de bronce comprimido de 8 cm. Cc.  
 52. Id. id. id. id. Detalles.  
 53. Granada incendiaria de 8 cm. Bote de metralla de 8 cm.=Bote de metralla de 9 cm.  
 54. Cartucho de 1.500 kgs. de pólvora de 6 á 10 mm. para C. Ac. ó Bc. 9 cm. Cc.=Cartucho de 1.250 kgs. de pólvora de 6 á 10 mm. para C. Bc. 8 cm.=Cartucho de 4 kgs. de pólvora prismática de 7 canales para C. B. 14 cm. Cc.=Cartucho de 7 kgs. de pólvora prismática de 7 canales para C. H. 15 cm. Cc. y de 6.200 kgs. de pólvora prismática para C. Ac. 15 cm. Cc.=Cartucho de 5.800 kgs. de pólvora prismática de 7 canales para O. H. R. 24 cm.  
 55. Cañón de bronce de 14 cm. Cc.  
 56. Empaque metálico Md. 1885 para pólvora granular.  
 57. Id. id. Md. 1886 para pólvora prismática.  
 58. Cañón de Ac. de 15 cm. cargado por la culata.  
 59. Id. id. id. id. Detalles.  
 60. Cañón de Ac. de 8 cm. largo, Cc. Reformado.  
 61. Cañón de hierro zunchado de 24 cm. Cc. Md. 1884.  
 62. Id. id. id. id. Detalles.  
 63. Id. id. id. id. Detalles.  
 64. Id. id. id. id. Detalles.  
 65. Id. id. id. id. Alza y punto de mira.  
 66. Granadas para C. H. 24 cm. Cc.  
 67. Llaves de espoletas modelo 1886.  
 68. Cartucho de 27 kgs. de pólvora prismática de 1 canal para C. H. 24 cm. Cc. Md. 1881.=Cartucho de 20 kgs. de pólvora prismática de 7 canales para C. H. 24 cm. Cc. con proyectil de tetones.  
 69. Granadas de metralla de 8 y 9 modelo 1887.

## SERIE B.

*Material de plaza, costa y sitio.*

- Lámina 51. Cureña de chapa Md. 1881 para C. B. 14 cm. Cc.  
 52. Avantren de cureña de chapa Md. 1881 para C. B. 14 cm. Cc. Detalles.  
 53. Cureña de chapa Md. 1881 para C. B. 14 cm. Cc. Detalles.  
 54. Id. id. id. id. Detalles.  
 55. Crik hidráulico de 10 tons. Md. 1883.=Crik hidráulico de 50 tons. Md. 1882.  
 56. Cureña de chapa Md. 1875 para C. Ac. 15 cm. Cc.  
 57. Id. id. id. id. Detalles.  
 58. Id. id. id. id. Detalles.  
 59. Cureña de chapa y avantren Md. 1875 para C. Ac. 15 cm. Cc.  
 60. Modificaciones introducidas en las cureñas de chapa Md. 1875 para C. Ac. 15 cm. Cc. construidas en Trubia.  
 61. Lanza para avantren y cureña de chapa Md. 1881 para C. B. 14 cm. Cc.  
 62. Disposición de la ametralladora Montigni, en casamata, para la defensa de los fosos.

63. Transformación del montaje para O. H. R. S. de 24 cm. de giro anterior en giro central.  
 64. Id. id. id. Detalles.  
 65. Truc de 50 tons. Md. 1887, componente de la pareja para transportar piezas hasta de 60.  
 66. Truc de 50 tons. Md. 1887. Detalles.  
 67. Id. de 15 tons. Md. 1887, componente de la pareja para transportar piezas hasta de 50 tons.  
 68. Truc de 15 tons. Md. 1887. Detalles.  
 69. Trucs de 15 y 50 tons. Md. 1887. Via férrea portátil y detalles.  
 70. Trucs de 15 y 50 tons. Md. 1887. Plataforma giratoria para la vía.  
 71. Carro de parque Md. 1887. (Vistas vertical y horizontal.)  
 72. Id. id. (Vistas anterior, posterior y detalles).  
 73. Montaje de giro central y marco alto para C. H. S. de 24 cm. Cc. Md. 1884.  
 74. Basa del montaje de giro central para C. H. S. 24 cm. Cc. Md. 1884.=Manivela reformada para cabria de costa. Md. 1859.  
 75. Juegos de armas.

## SERIE C.

*Material de batalla.*

- Lámina 56. Pinzote porta-rueda del material Md. 1868 Rf. 1880 modificado, para colocar la rueda de la cureña de chapa de 8 cm.=Reformas de las cajas de cartuchos del material, Md. 1868 Rf. 1880, para C. Bc. 8 cm. Cc.=Almohadón para cureña de C. 8 cm. Cc.  
 57. Cureña de chapa Md. 1880 para C. Ac. Rf. y Bc. de 8 cm. Cc.  
 58. Id. id. id. Detalles.  
 59. Id. id. id. Detalles.  
 60. Id. id. id. Detalles.  
 61. Id. id. id. Detalles.  
 62. Id. id. id. Detalles.  
 63. Modificaciones introducidas en las cajas de armón y carro del material de 9 cm. Md. 1878 reformado al 84, según circular de 26 de Noviembre de 1885.

## SERIE D.

*Material de Montaña*

- Lámina 19. Reforma del hueco para cartuchos de las cajas Md. 1874 y faldoncillo para cubrir la caja porta-cebos.  
 20. Reforma del hueco para cartuchos en las cajas. Modelo 1865 Rf. al 74.

## SERIE E.

*Armas portátiles, blancas, de fuego y municiones de estas.*

- Lámina 23. Sable para tropa de caballería.=Machete Md. 1881.=Abrazaderas del fusil Md. 1871, reformadas por R. O. de 8 de Noviembre de 1885.



# CAÑÓN DE BRONCE COMPRIMIDO 8 cm. Cc. DETALLES.

Collarin (1/2)

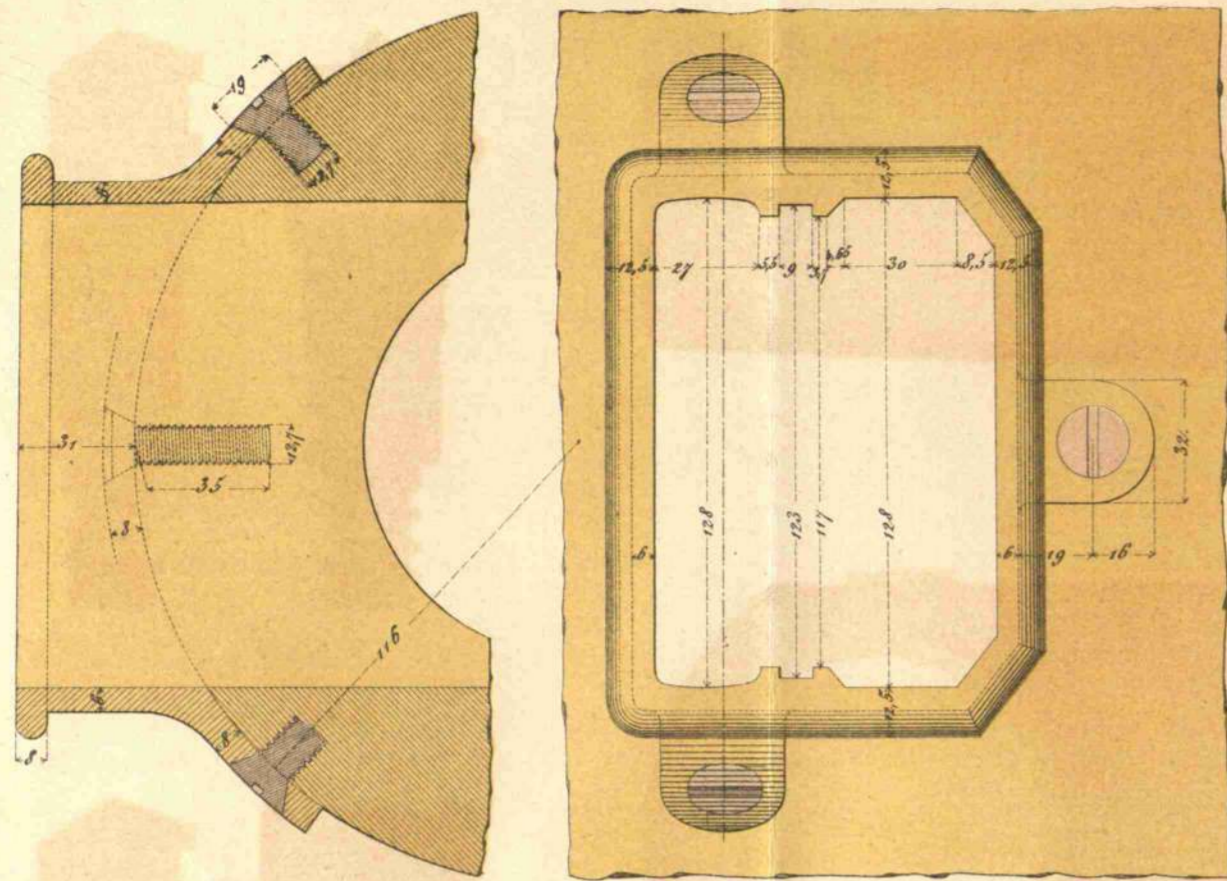

Plato de la cuña (1/2)

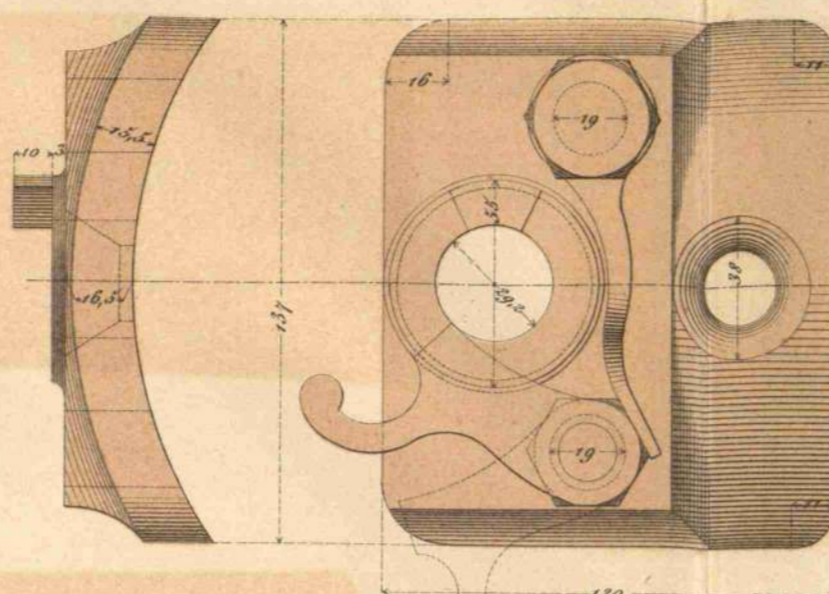

Cuña (1/2)

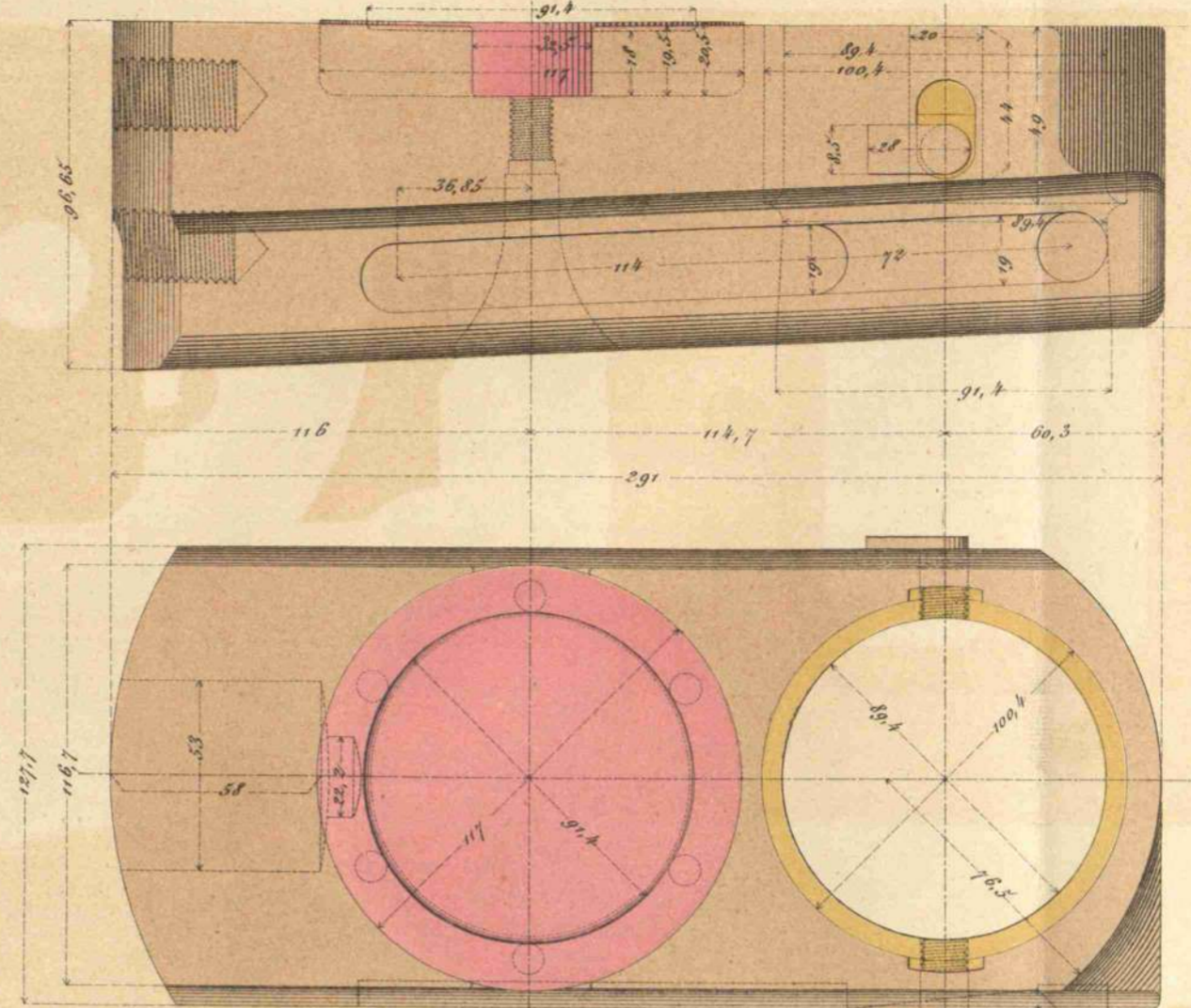

Punto de mira (1/4)

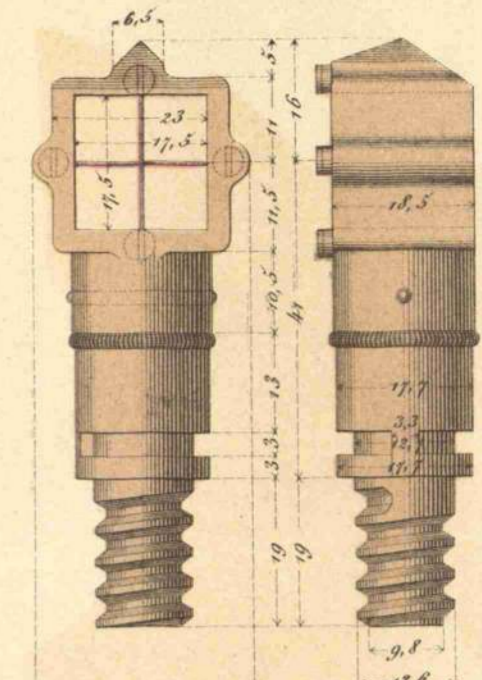

Tope de retenida (1/2)

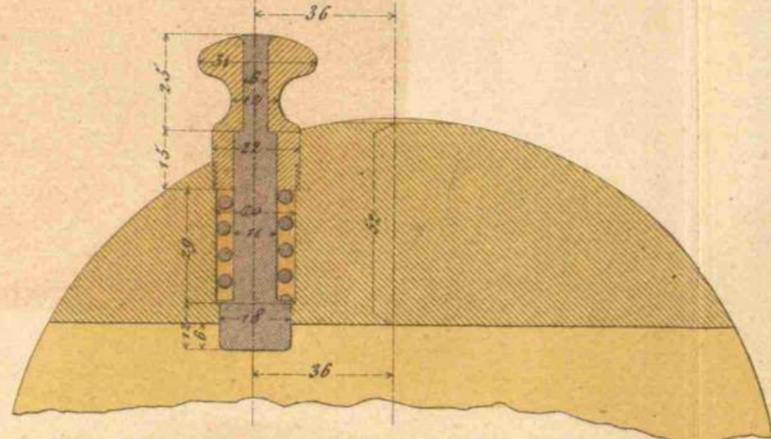

Husillo del cierre (1/2)

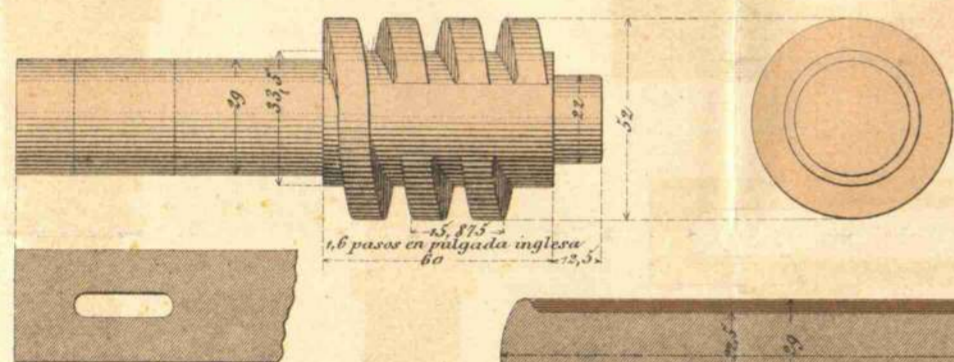

Manivela del cierre (1/2)

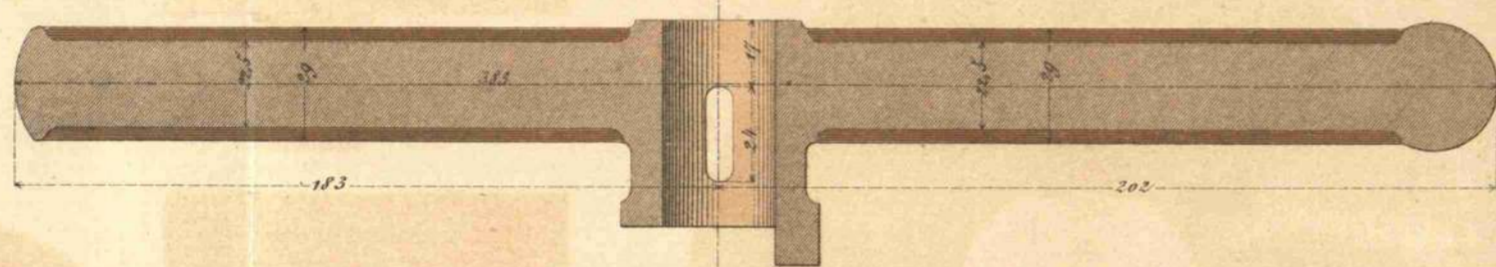

Grano (1/2)

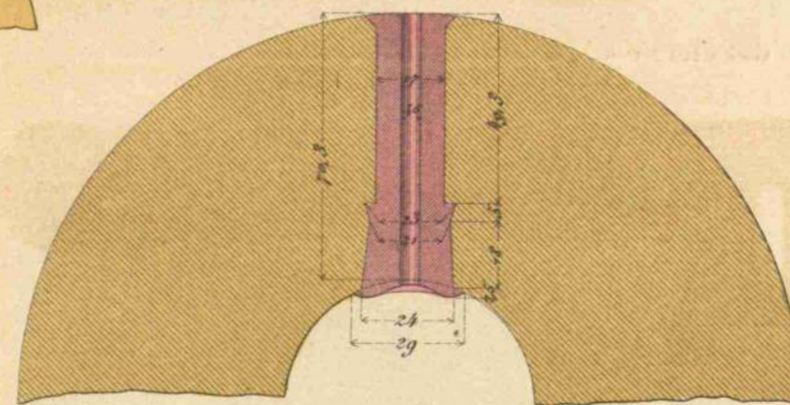

Alza (1/4)

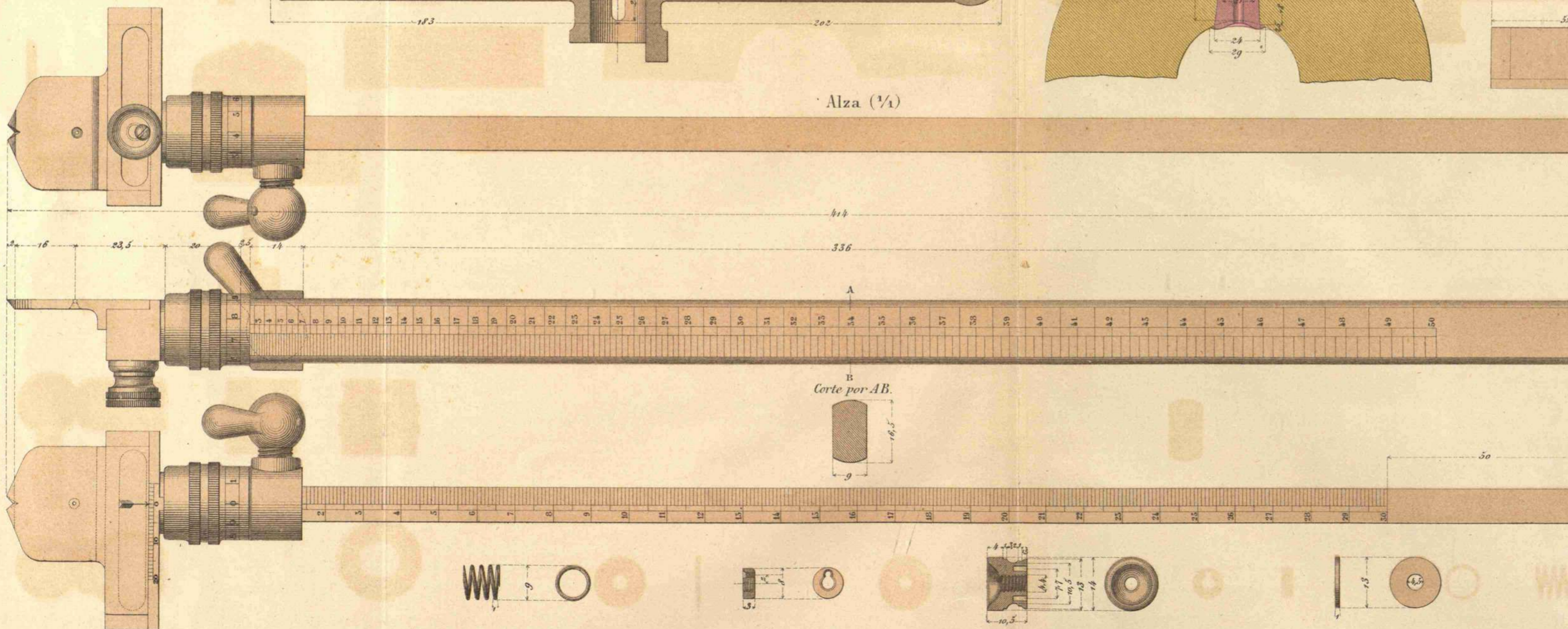

Corte por MN

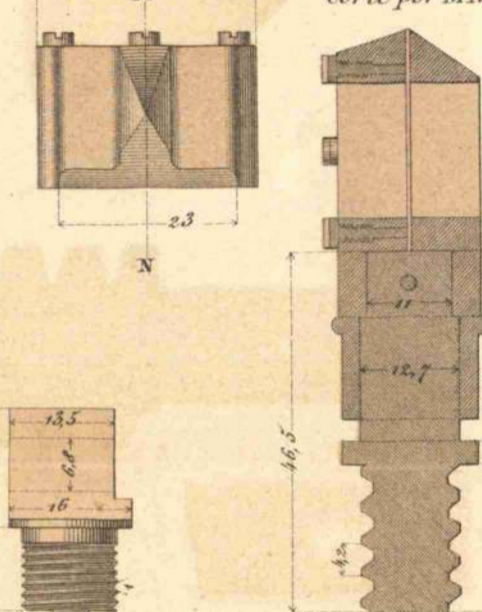



GRANADA INCENDIARIA DE 8 CM.

MD. 1880. (1/4)

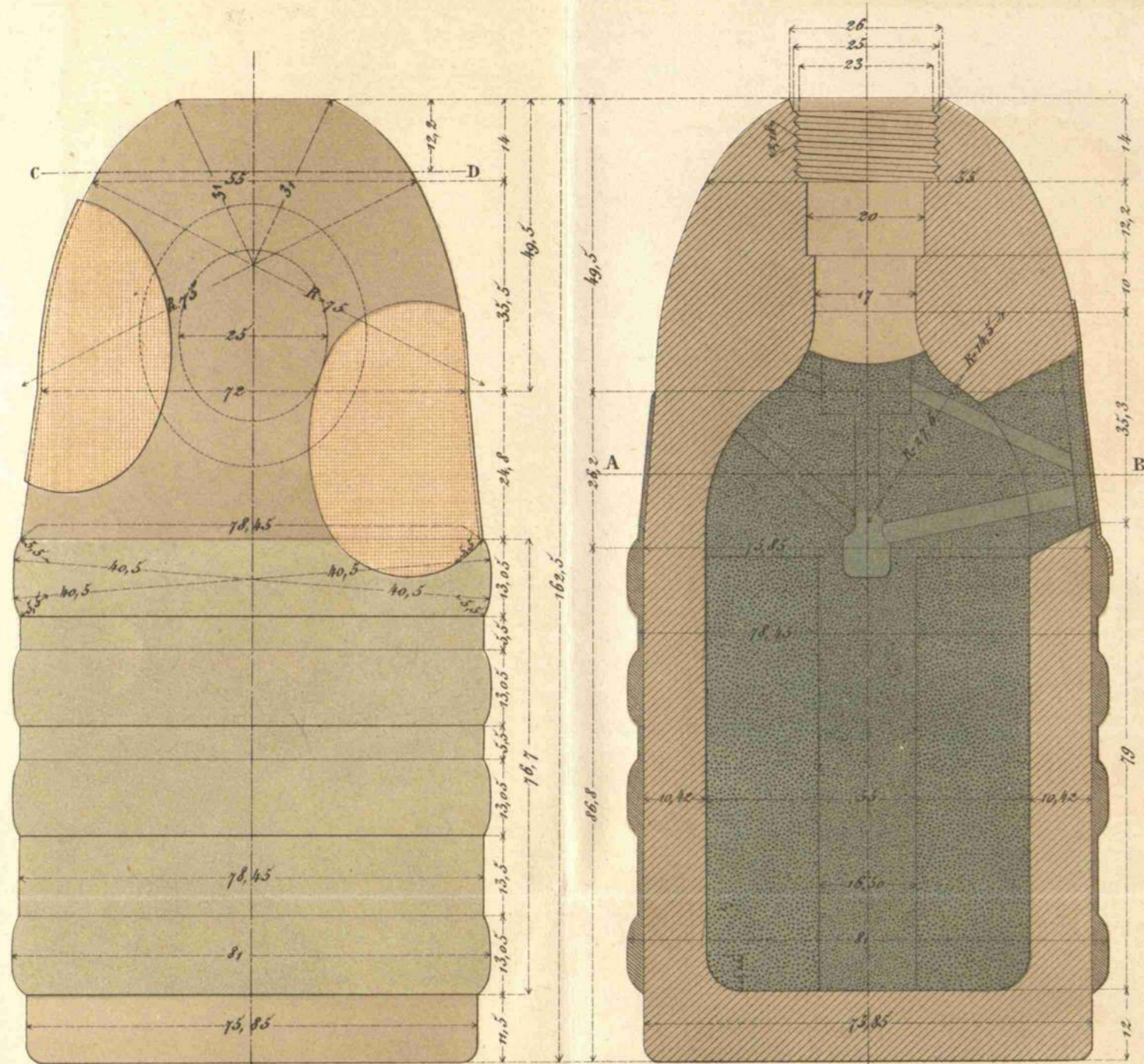

Corte por C.D.

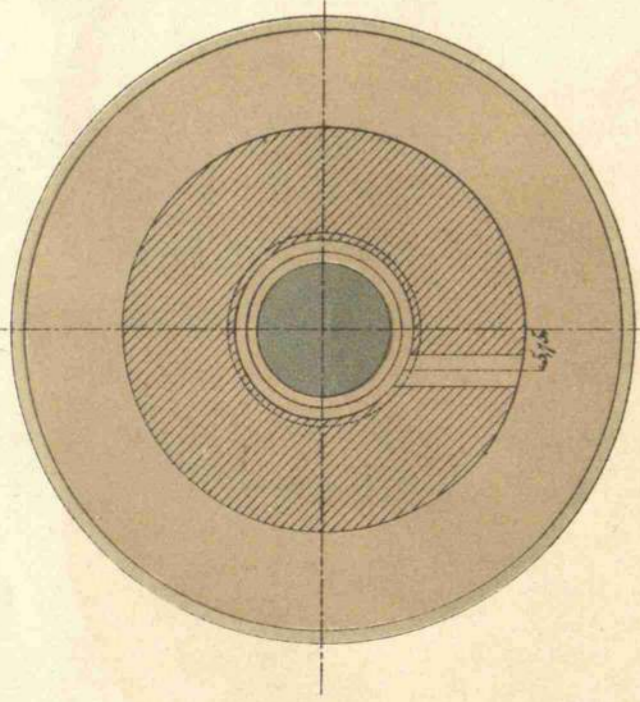

Corte por A.B.

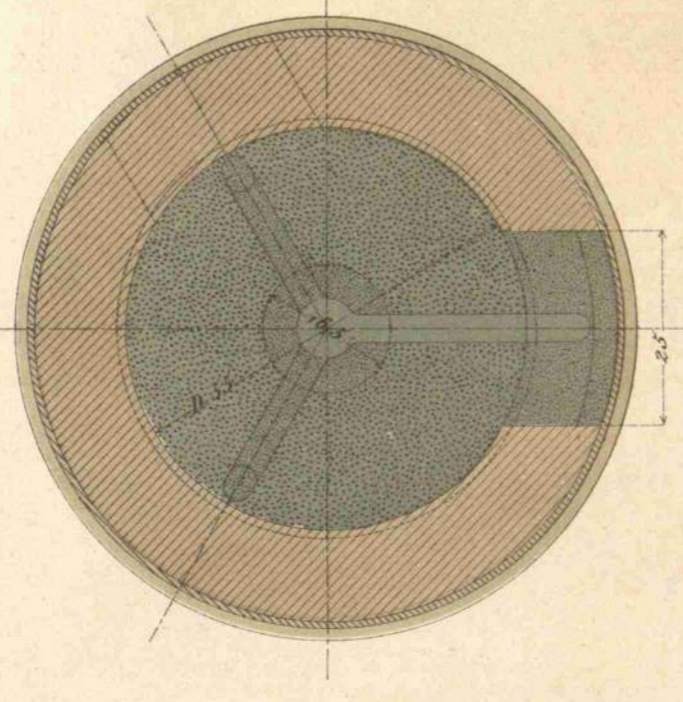

BOTE DE METRALLA DE 8 CM.

MD. 1884. (1/4)

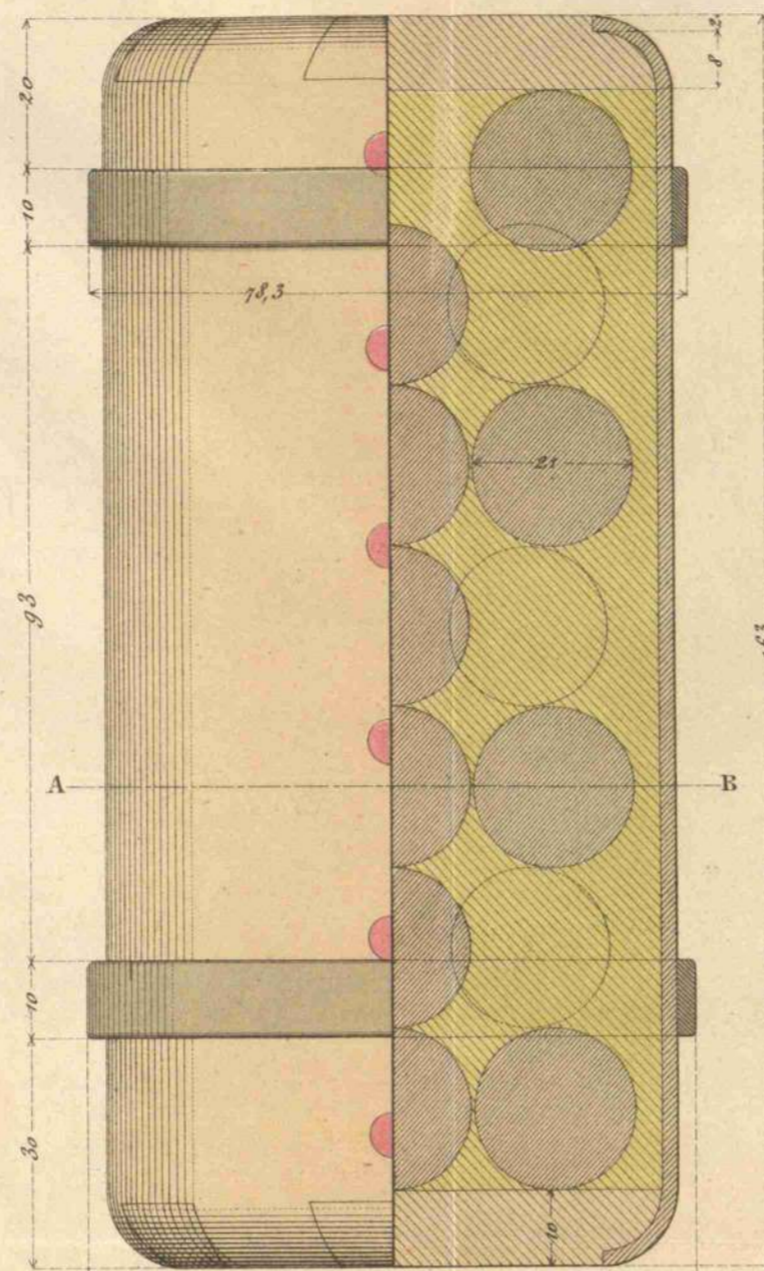

Corte por A.B.

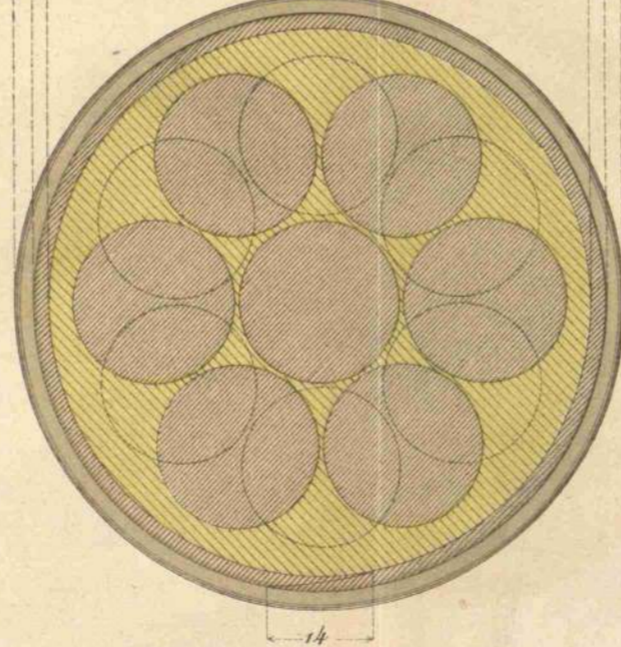

Culote para bote de metralla de 8 cm (1/4)

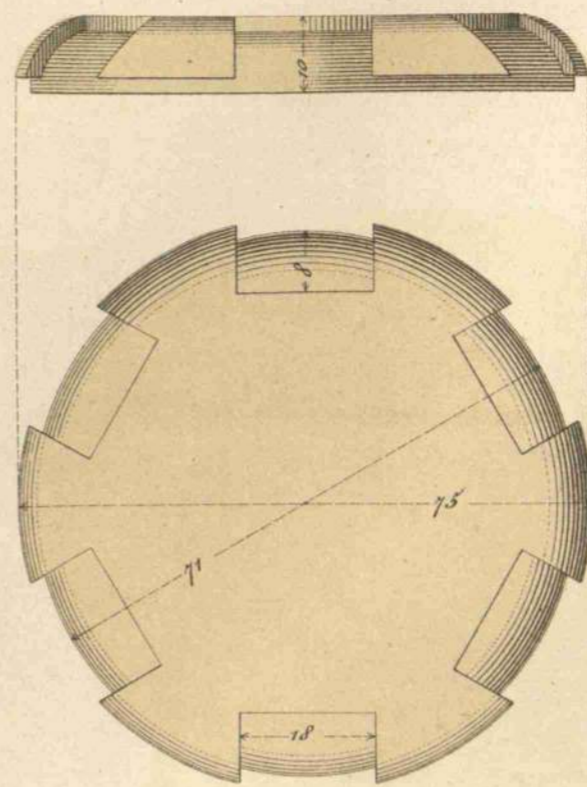

Culote para bote de metralla de 9 cm (1/4)

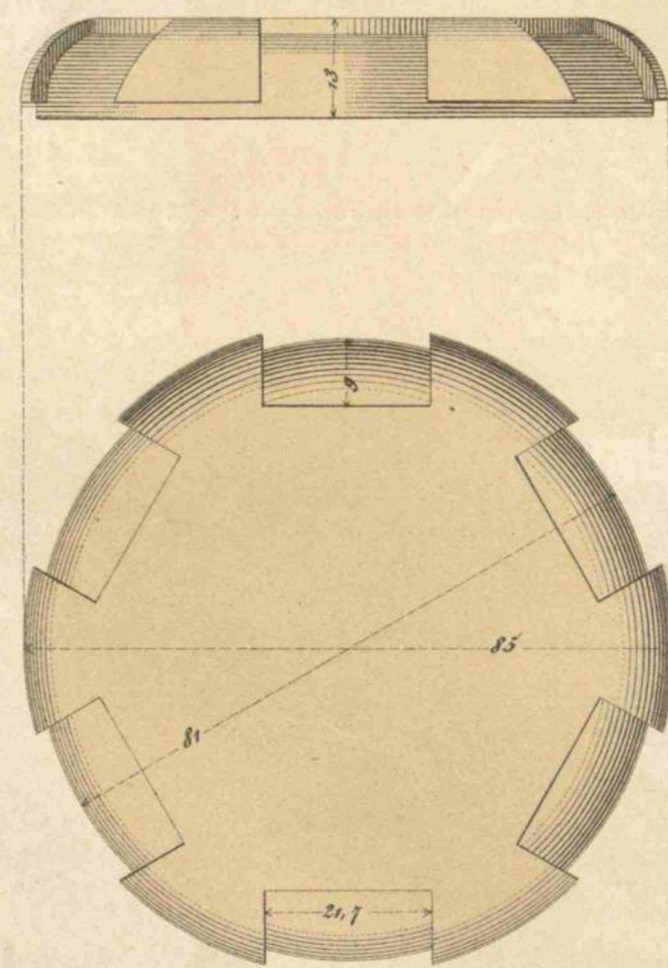

BOTE DE METRALLA DE 9 CM.

MD. 1884. (1/4)

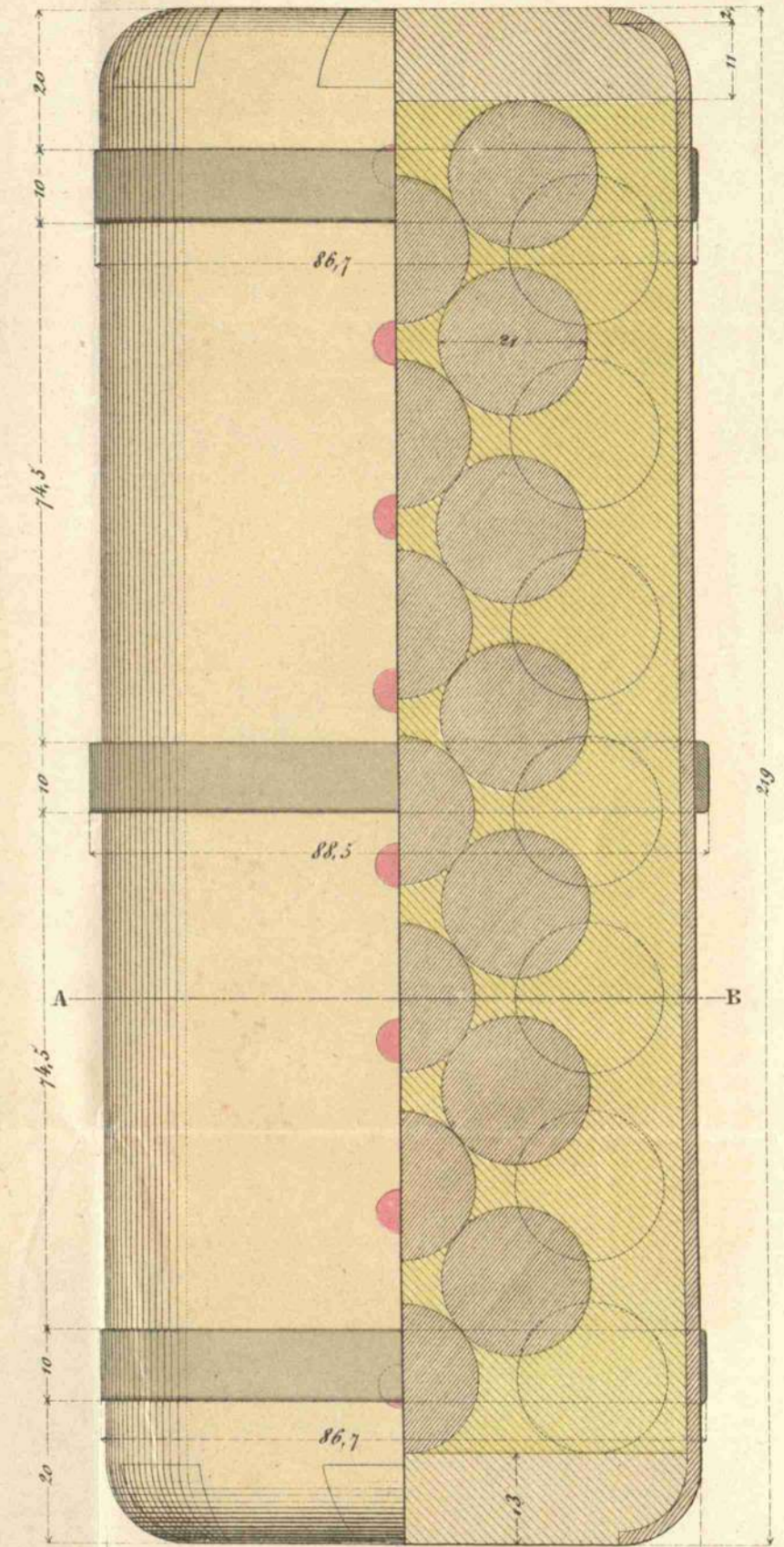

Corte por A.B.

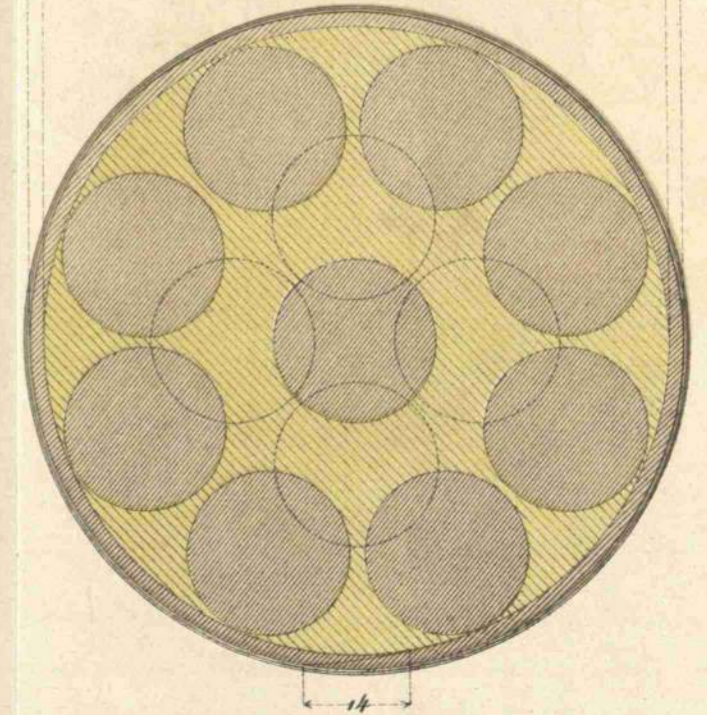

	Bote de metralla de 8 cm.	Bote de metralla de 9 cm.
Peso de la metralla	1,680 Kg.	3,185 Kg.
Id. de la chapa y remaches	0,545 "	0,800 "
Id. de los dos culotes	0,530 "	0,920 "
Id. del axufre	0,561 "	0,675 "
Id. de los anillos	0,109 "	0,105 "
Id. del bote concluido	3,425 "	5,685 "
Núm <sup>o</sup> de balines	48	91
Peso de cada uno	35 g.	35 g.

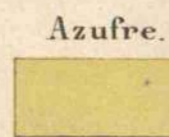



Cartucho de 1,500 Kg de pólvora de 6 à 10 mm. para C. Ac. ó Bc. 9 Ce. (2/5)

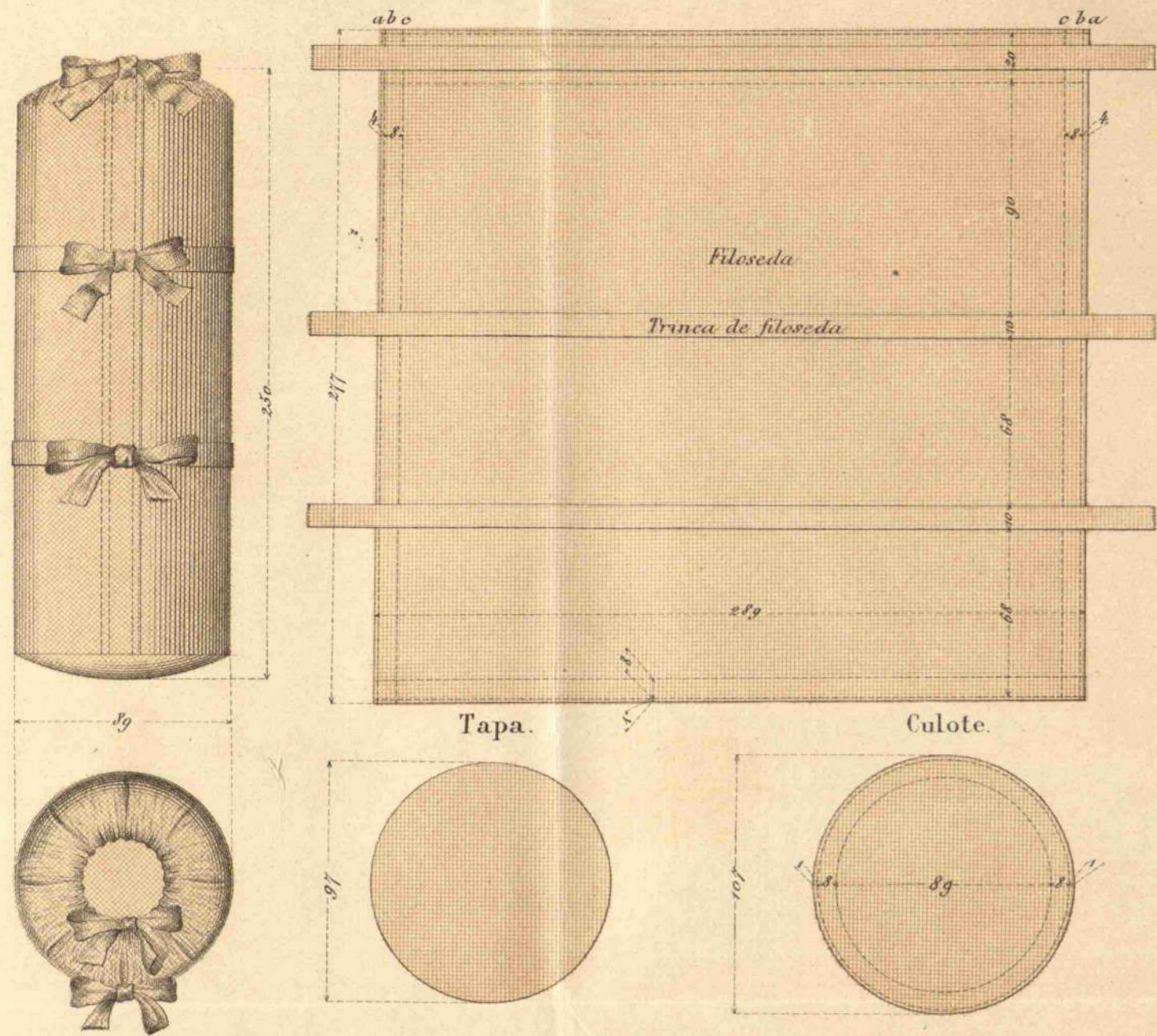

Cartucho de 1,250 Kg de pólvora de 6 à 10 mm. para C. Bc. 8 Ce (2/5)

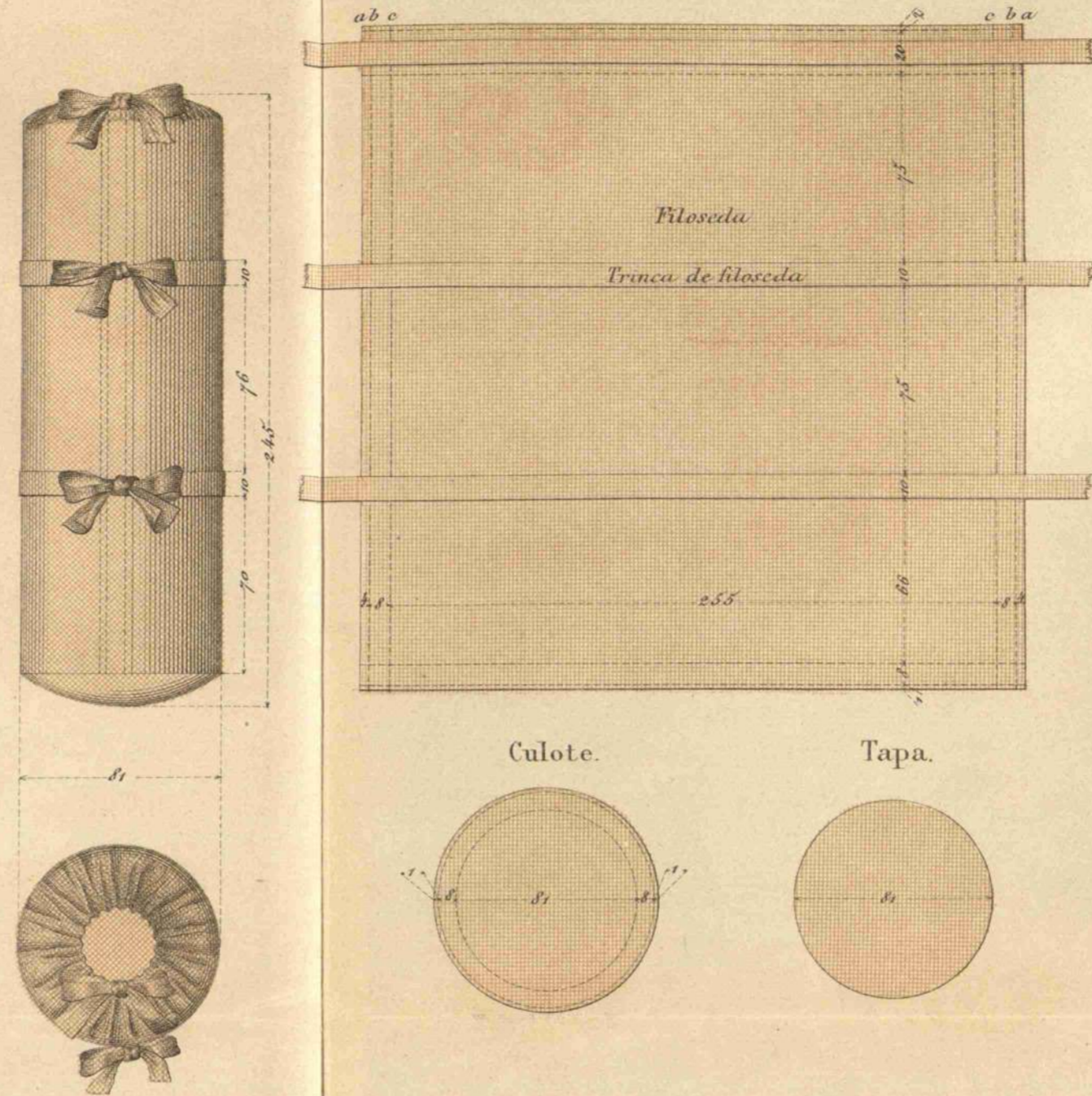

Cartucho de 4 Kg de pólvora prismática de 7 canales para C. B. 14. Ce (1/5)

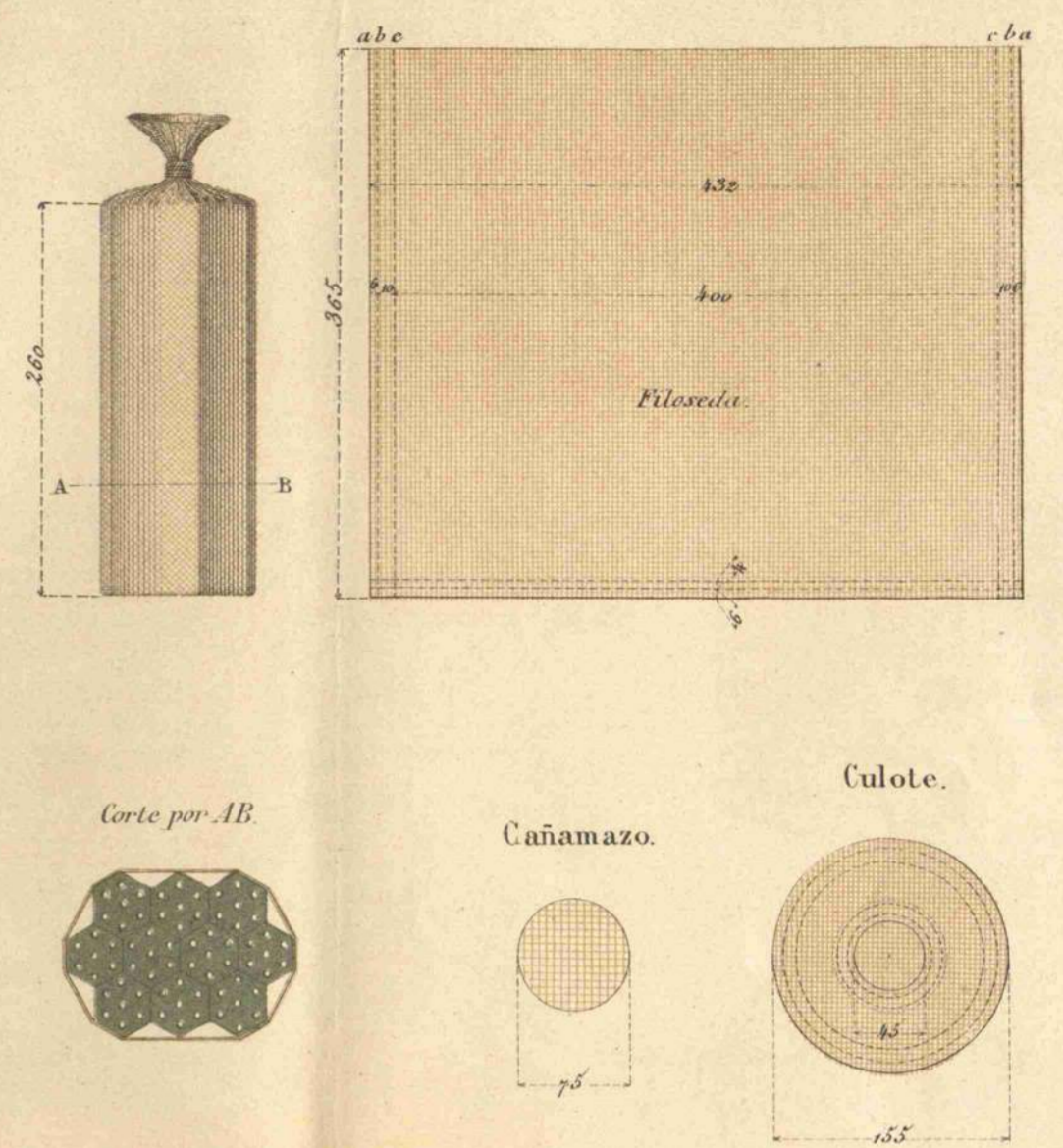

Cartucho de 7 kg. de pólvora prismática de 7 canales para C. H. 15 Ce. } (1/5)  
y de 6,200 Kg. id. id. id. para C. Ac. 15. Ce. }

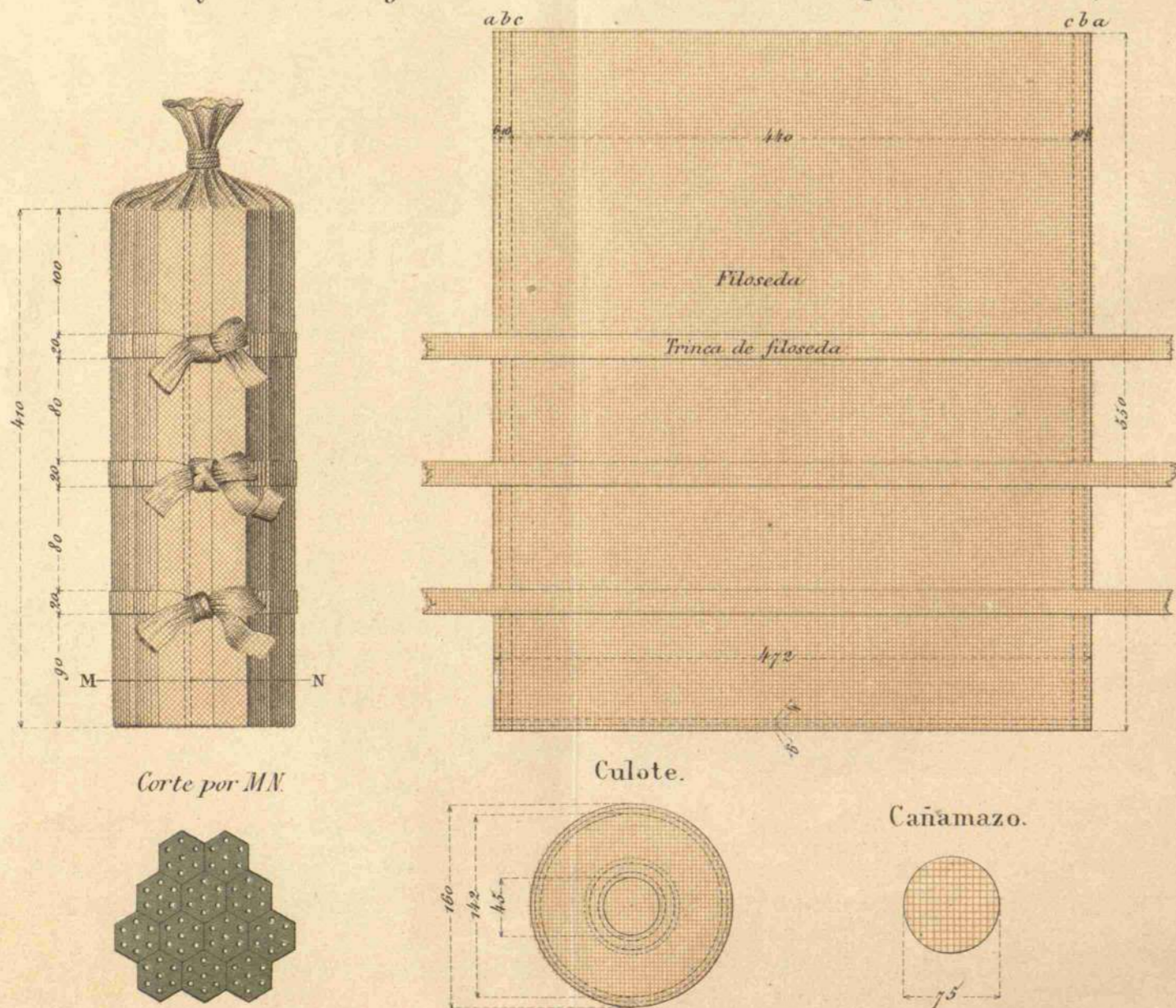

Cartucho de 5,800 Kg. de pólvora prismática de 7 canales para O. H. R. 21. (1/5)

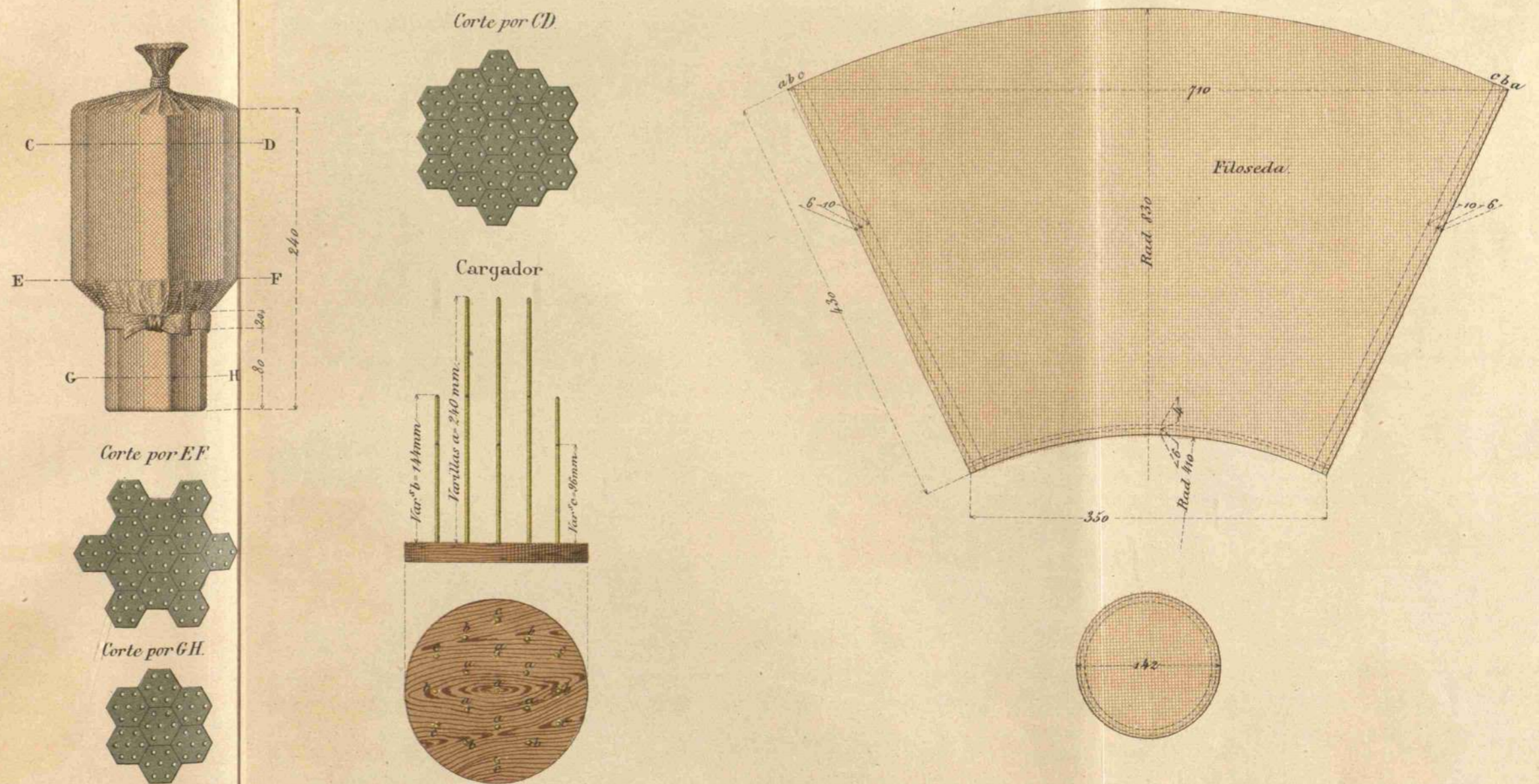



# CAÑÓN DE BRONCE DE 14. Ce.

(1/10)

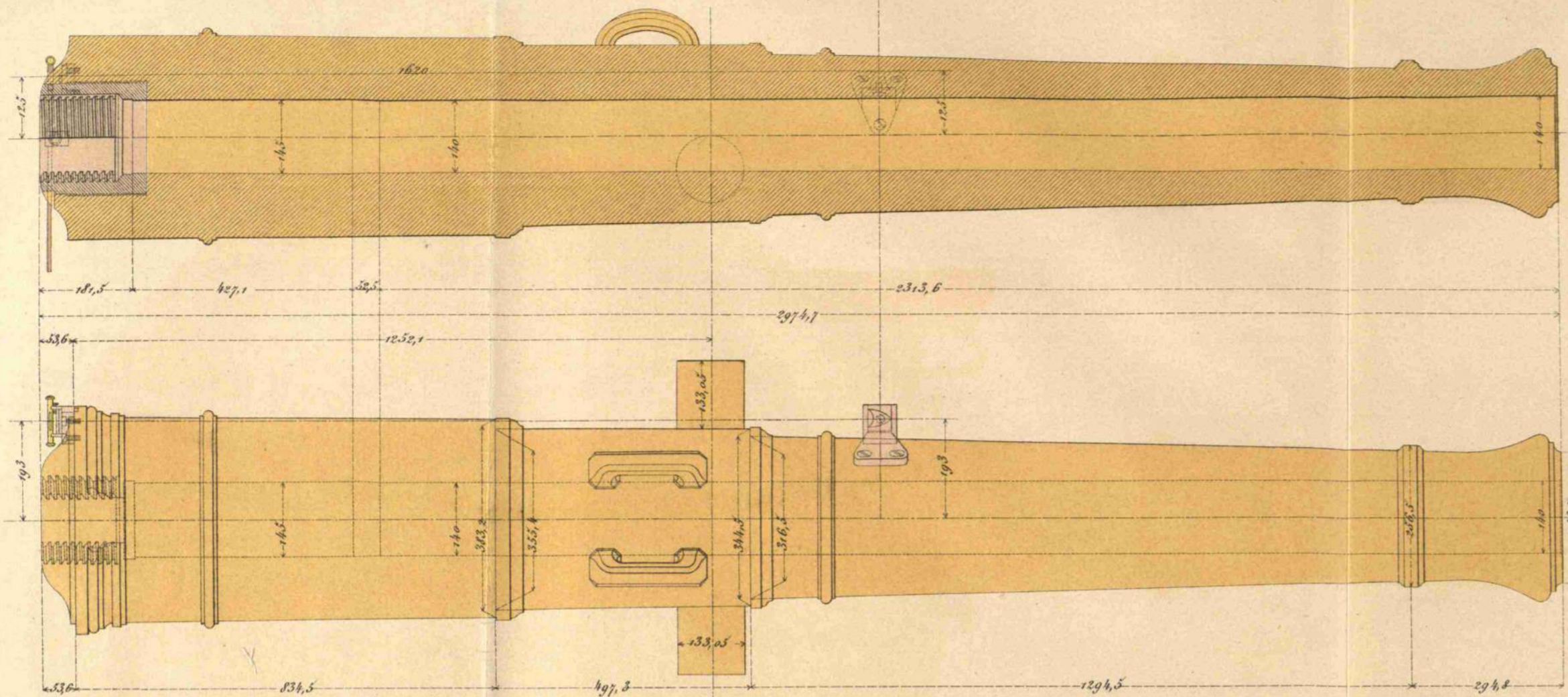

(2/5)

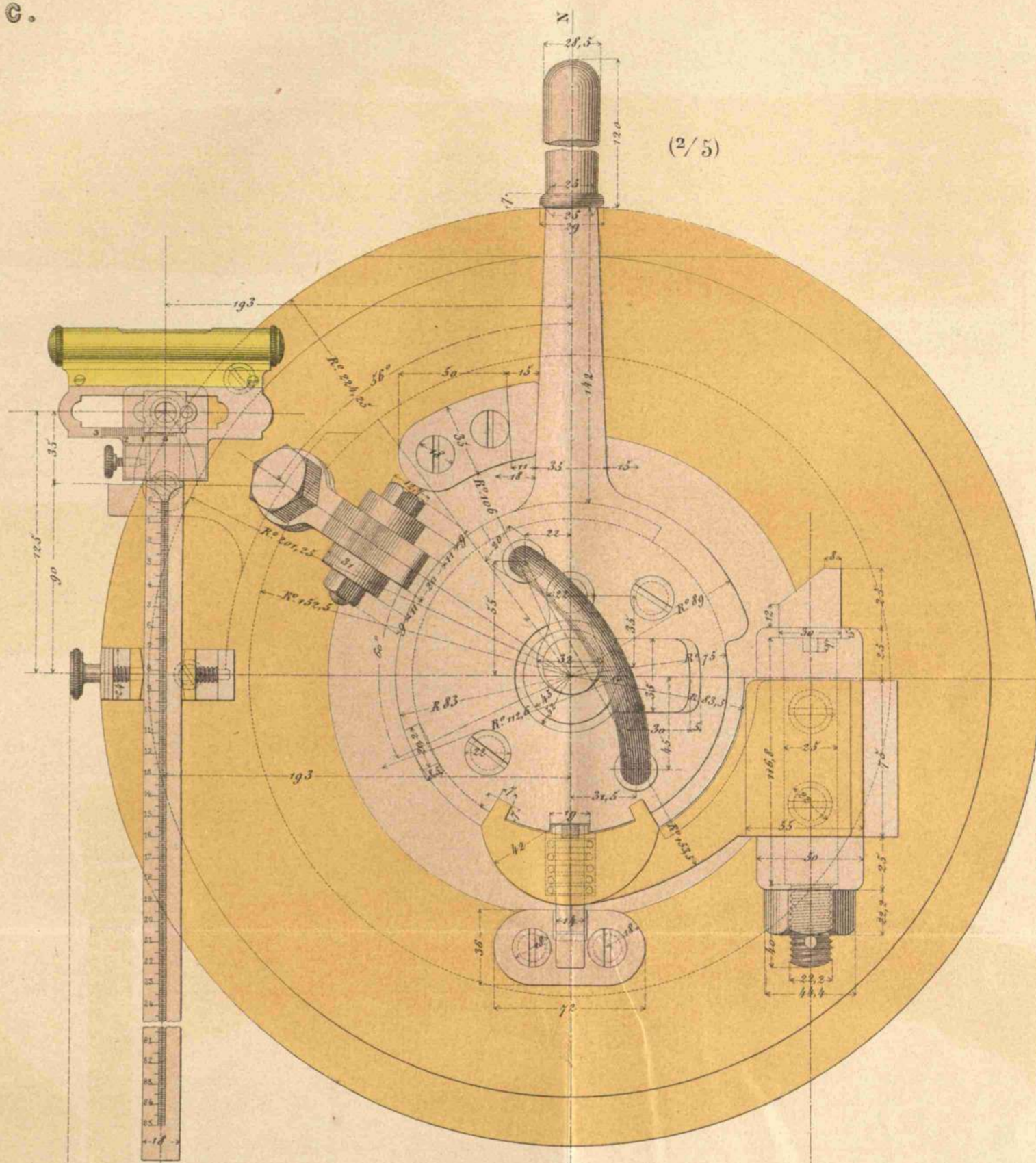

(1/1)

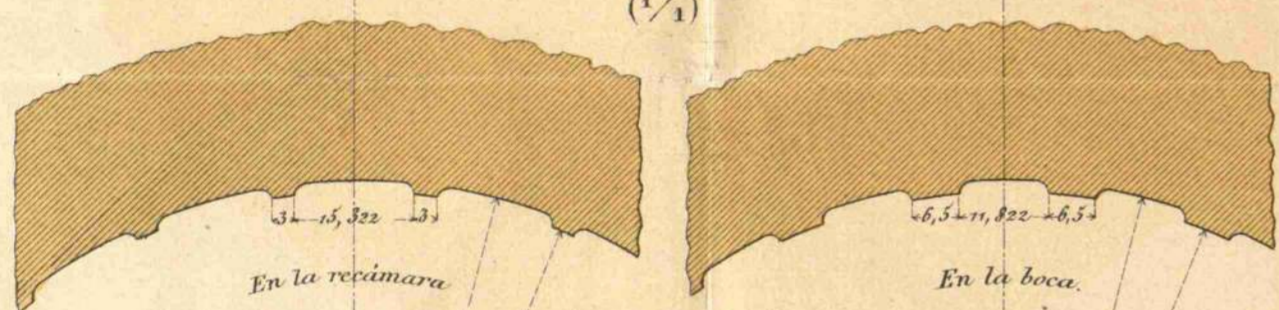

En la retámarca

En la boca.

Corte por M.N.

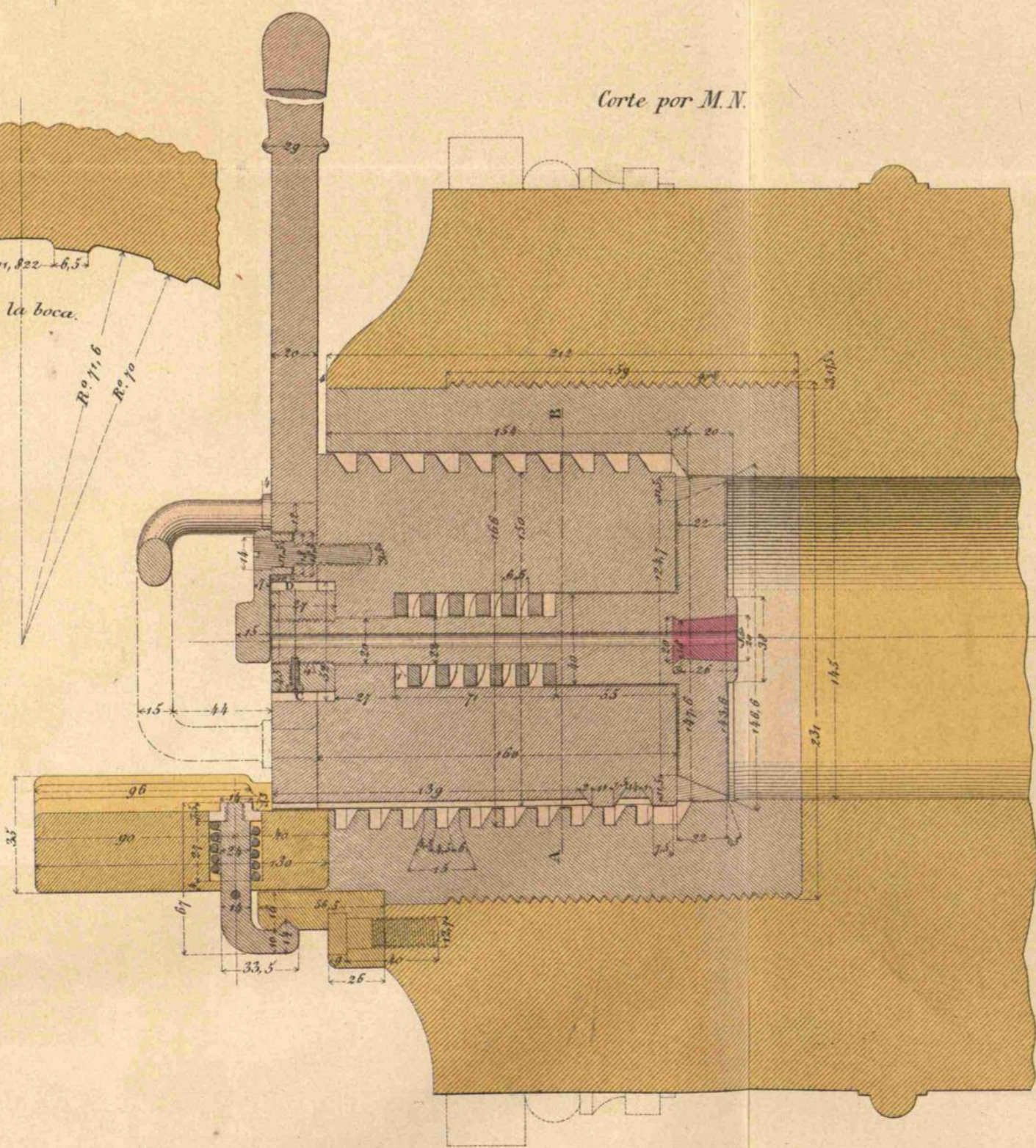

Corte por A.B.

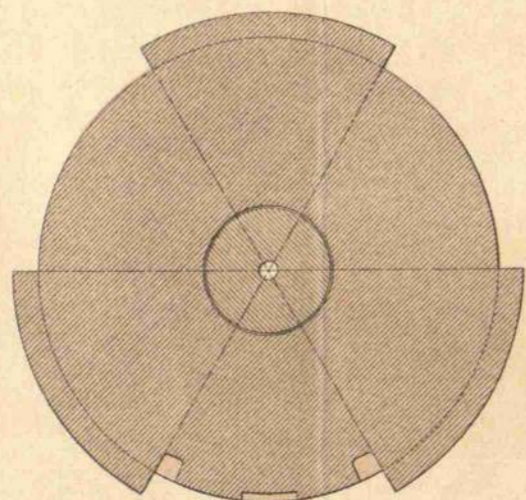

Corte por C.D.





# EMPAQUE METALICO MODELO 1883 PARA POLVORA GRANULAR.

Em. Mo. Md. 1883. Pol. Gr.

Vistas generales (1/5)

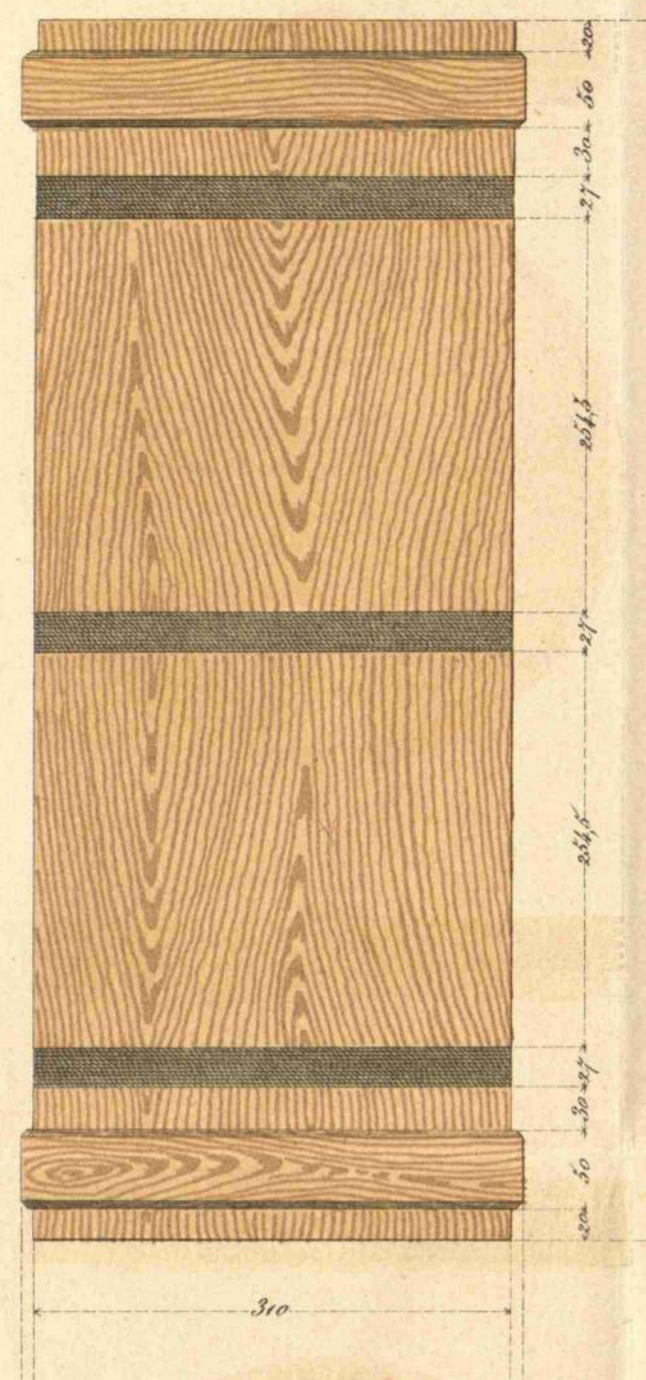

Corte por AB.

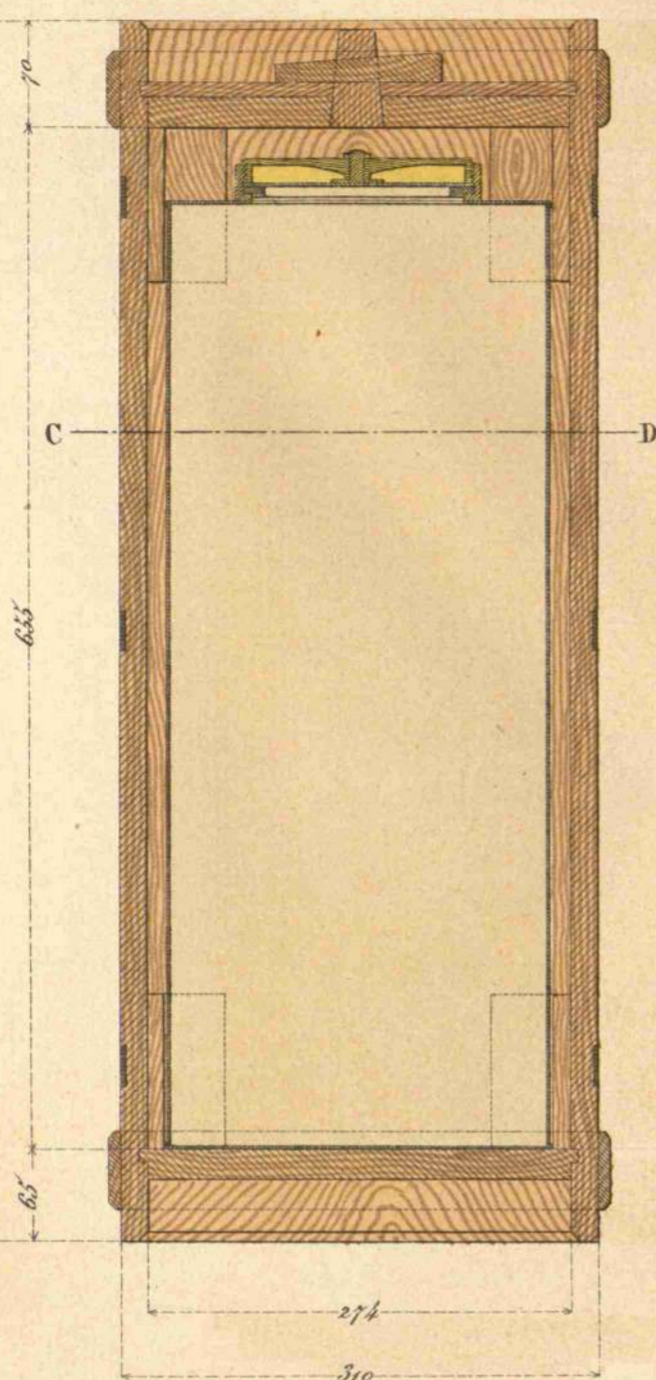

Costados del cajon de madera (1/5)

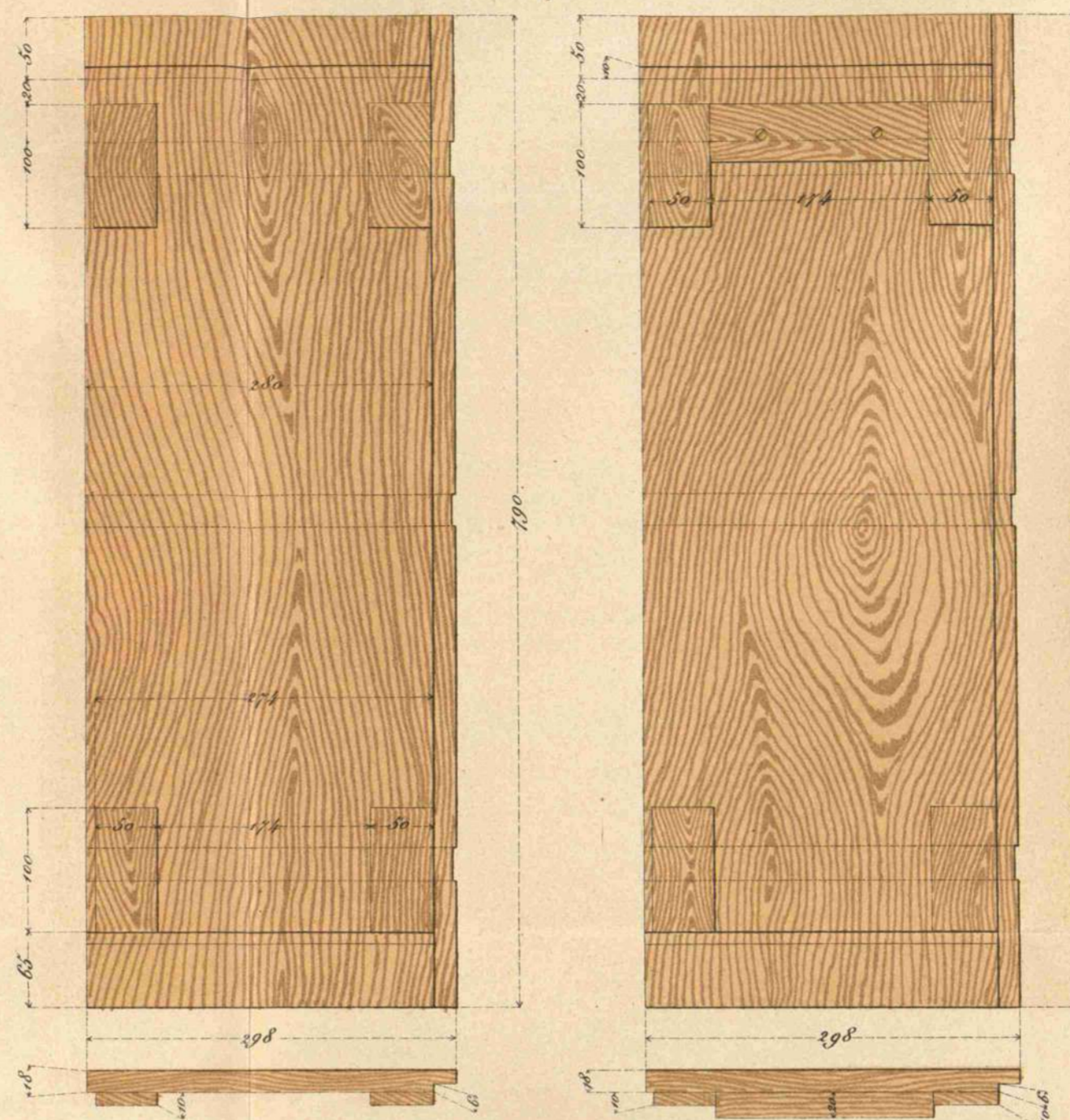

Cierre de giro independiente (1/2)

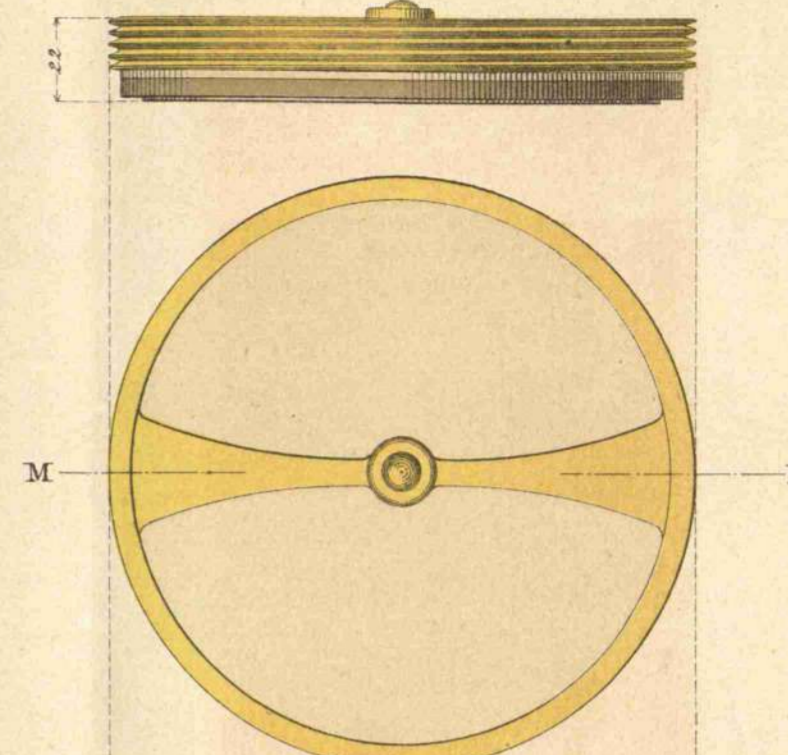

Corte por MN.

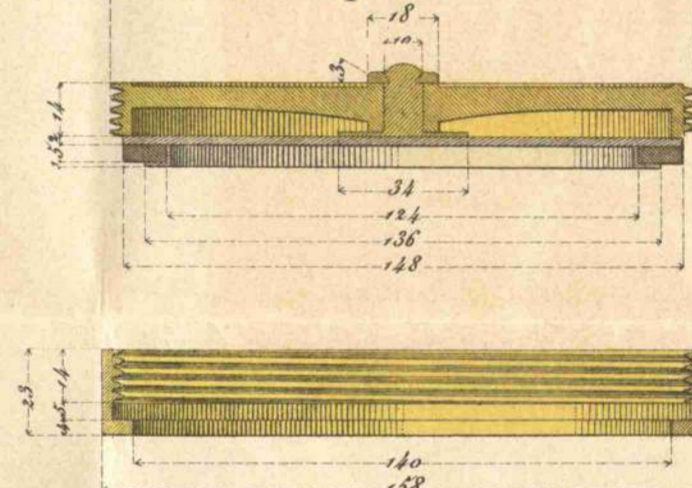

Corte por CD.

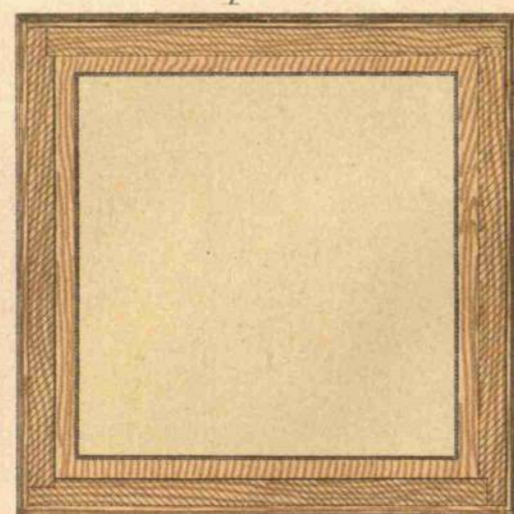

Desarrollo de la caja de zinc (1/5)

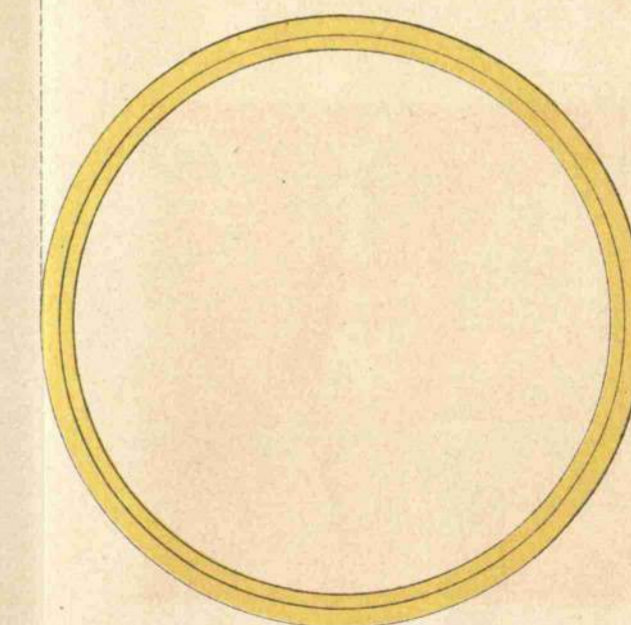
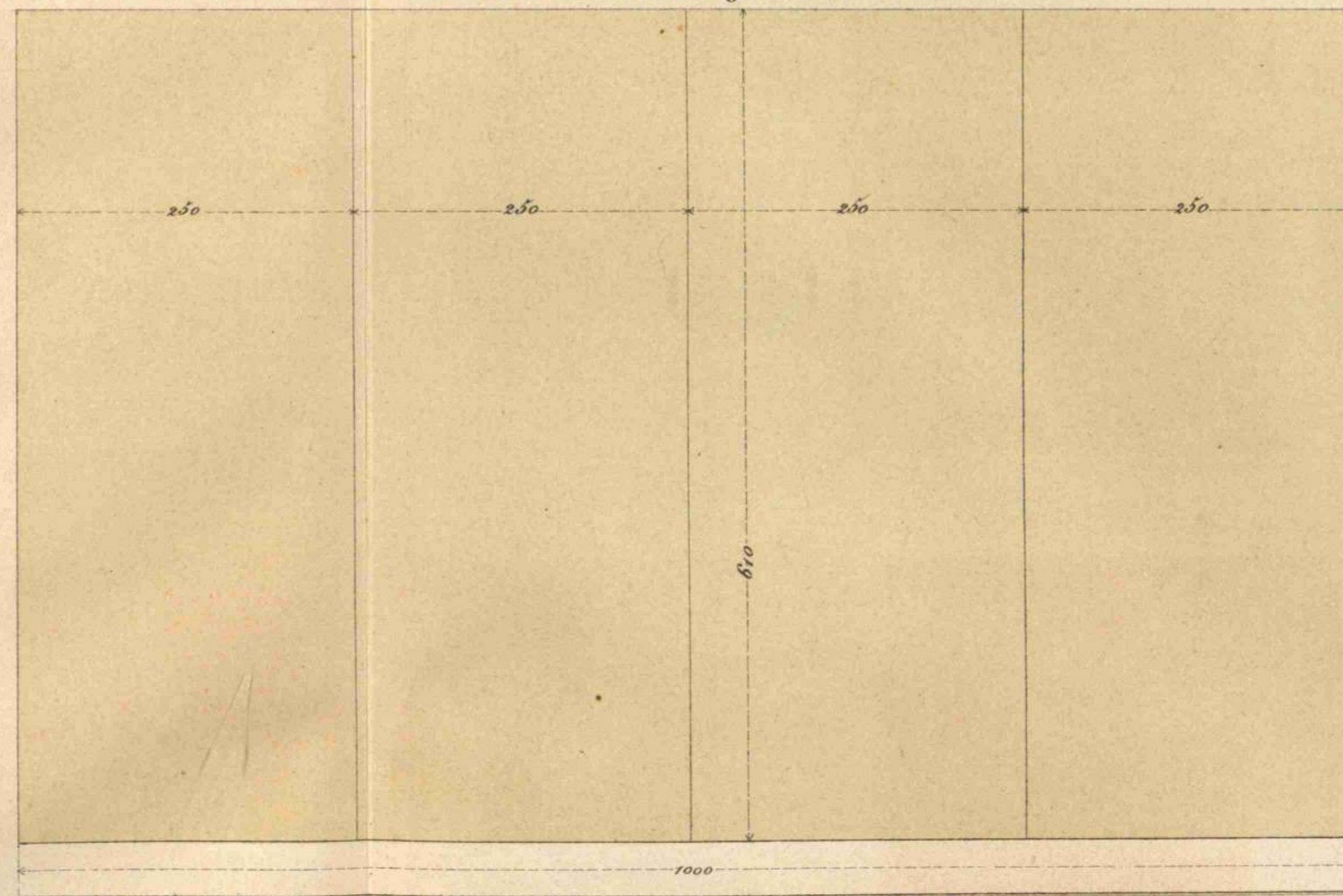

Cubierta de la caja de zinc (1/5)

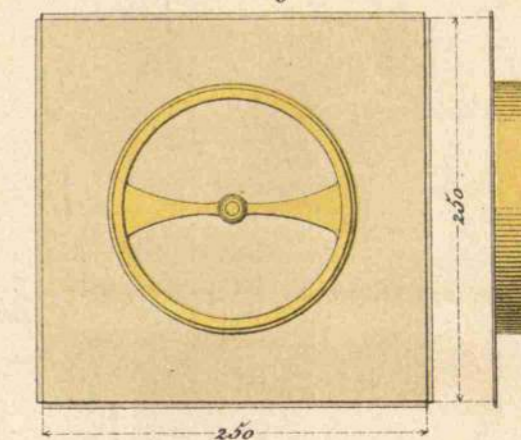

Crucetas para cerrar el cajon (1/5)

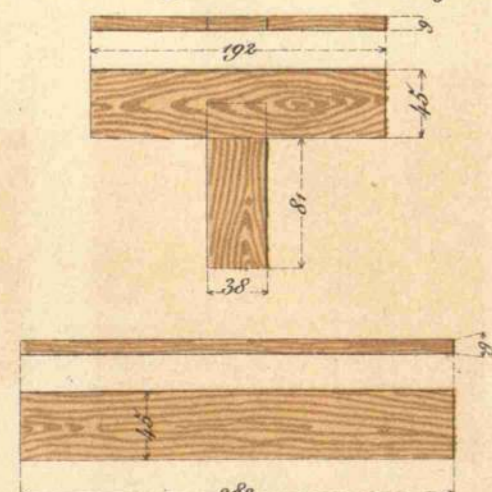

Tapa del cajon (1/5)

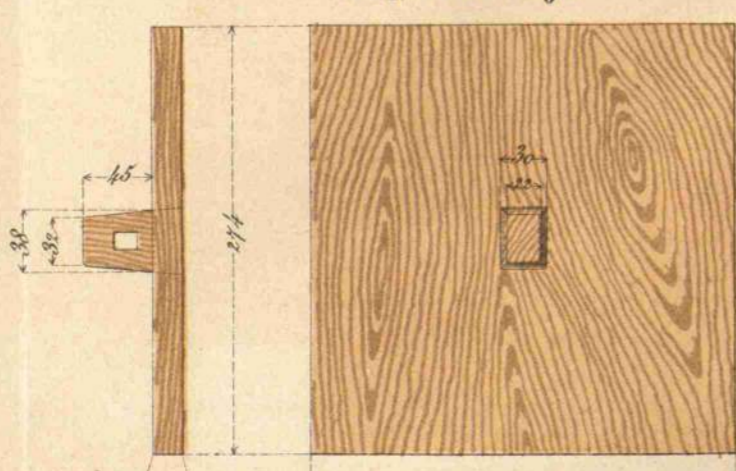



# EMPAQUE METALICO MODELO 1886 PARA POLVORA PRISMATICA.

Em. Mo. Md. 1886. Pol. Pris.

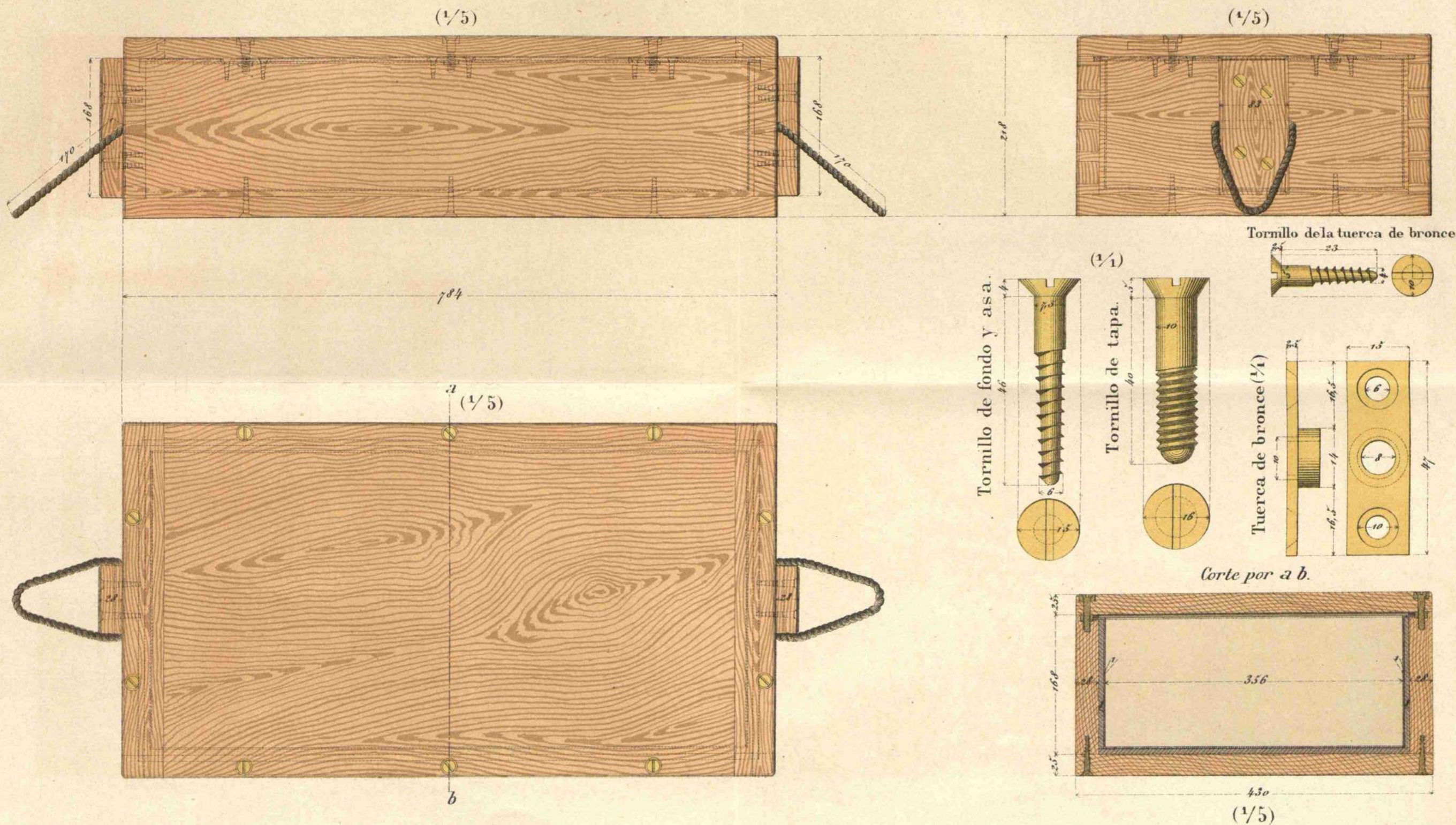



# CAÑÓN DE ACERO DE 15 CARGADO POR LA CULATA.

C. Ac. 15. Cc.

Escala 1/10.

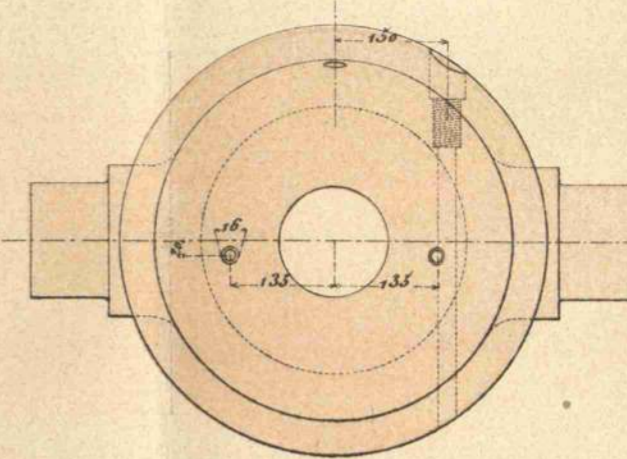
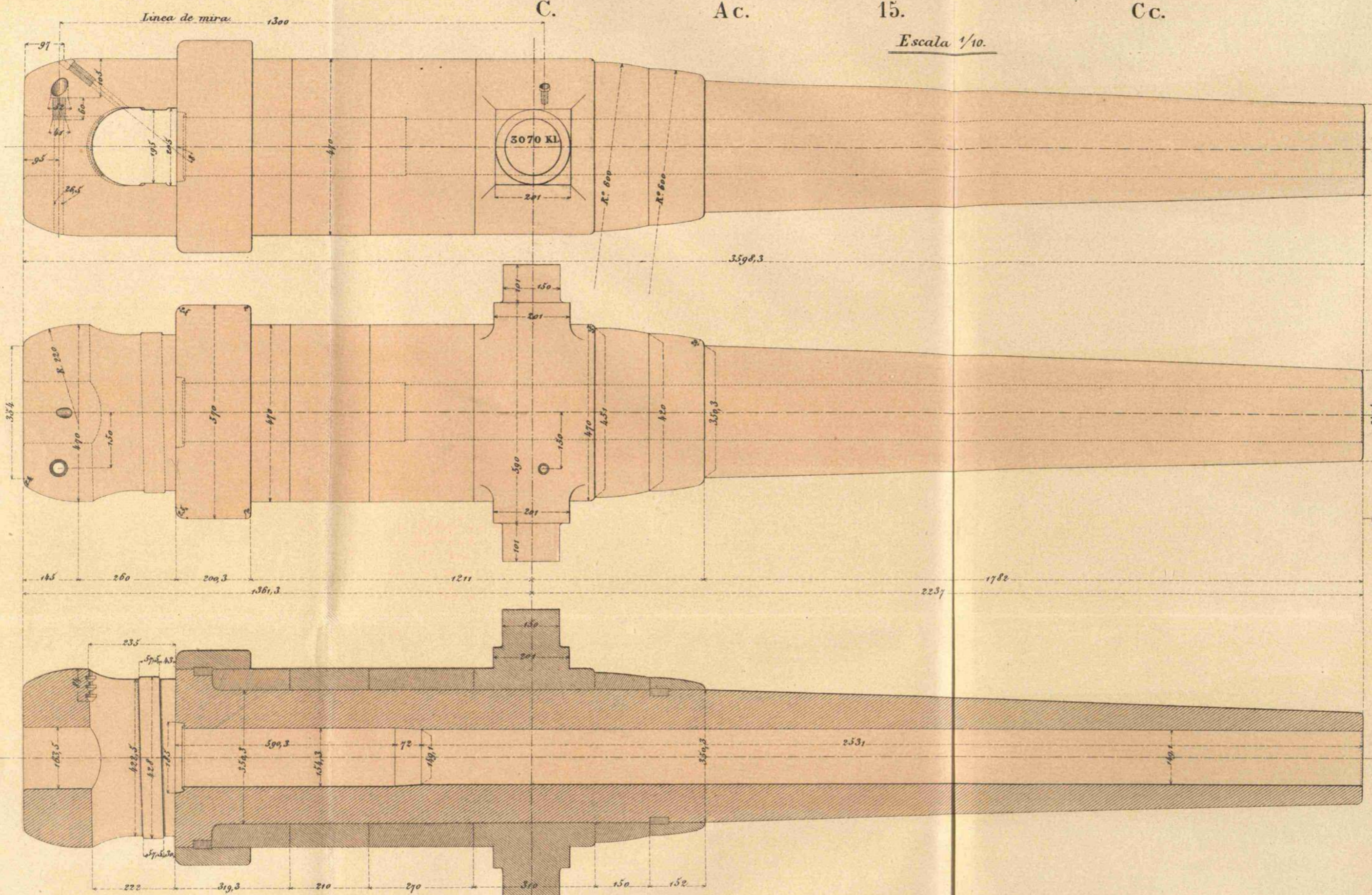

Corte de la mortaja y cuña cerrada, por el plano vertical que pasa por el eje de la pieza (1/5)

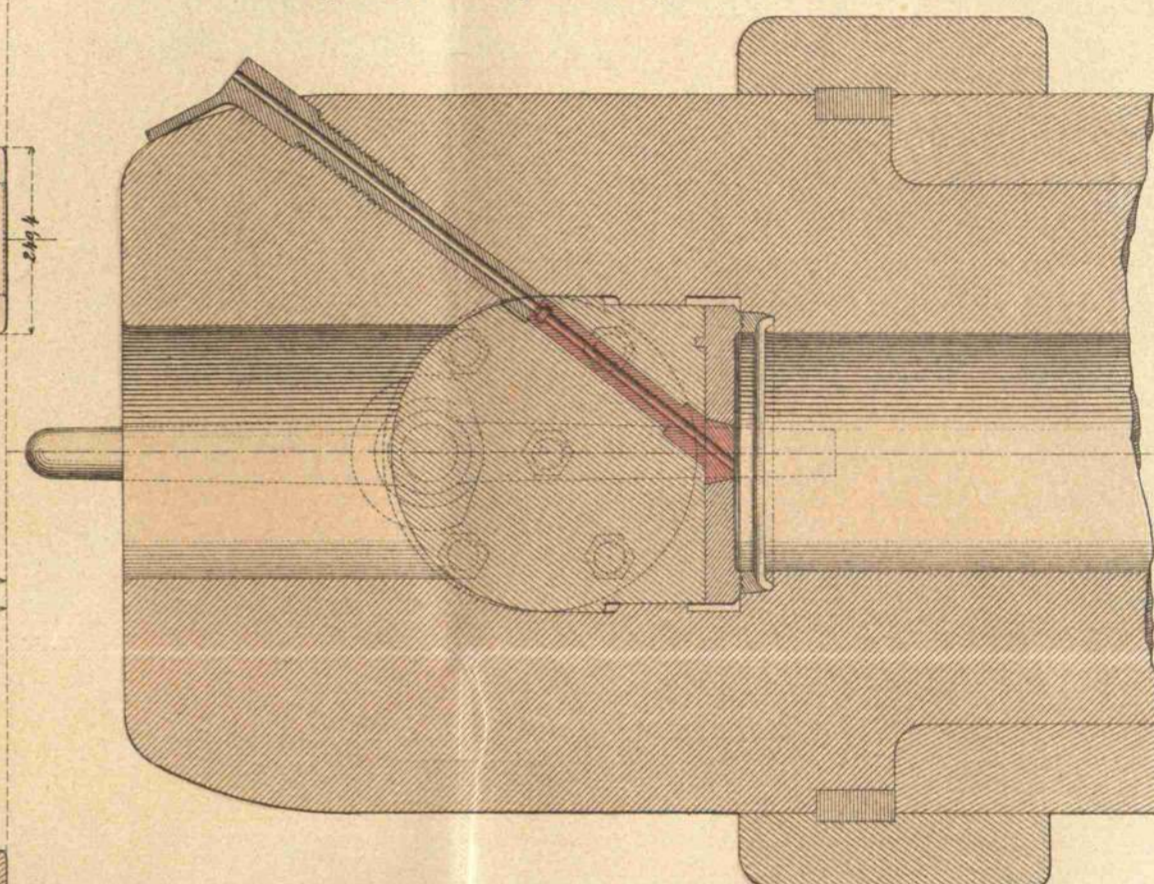

Corte de la mortaja y cuña cerrada, por el plano horizontal que pasa por el eje de la pieza (1/5)

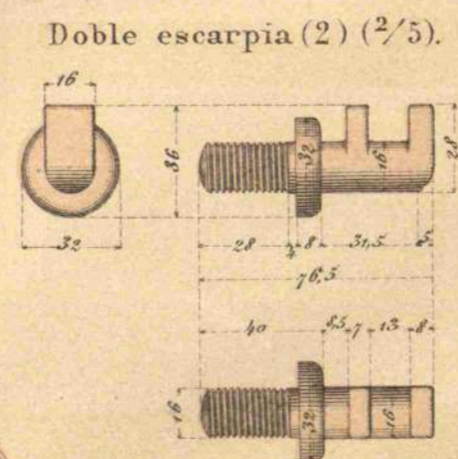
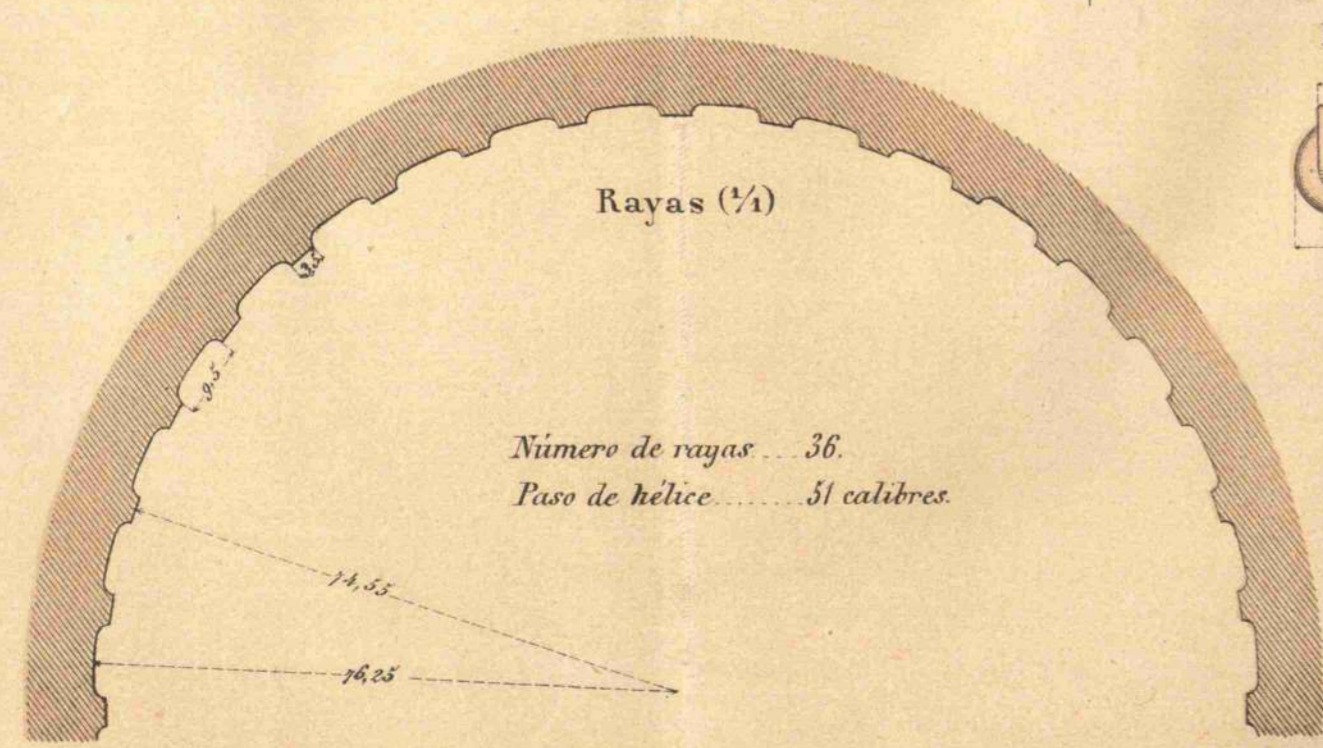

Peso de la pieza... 3010 Kg.  
Preponderancia en plano de la culata... 25 "

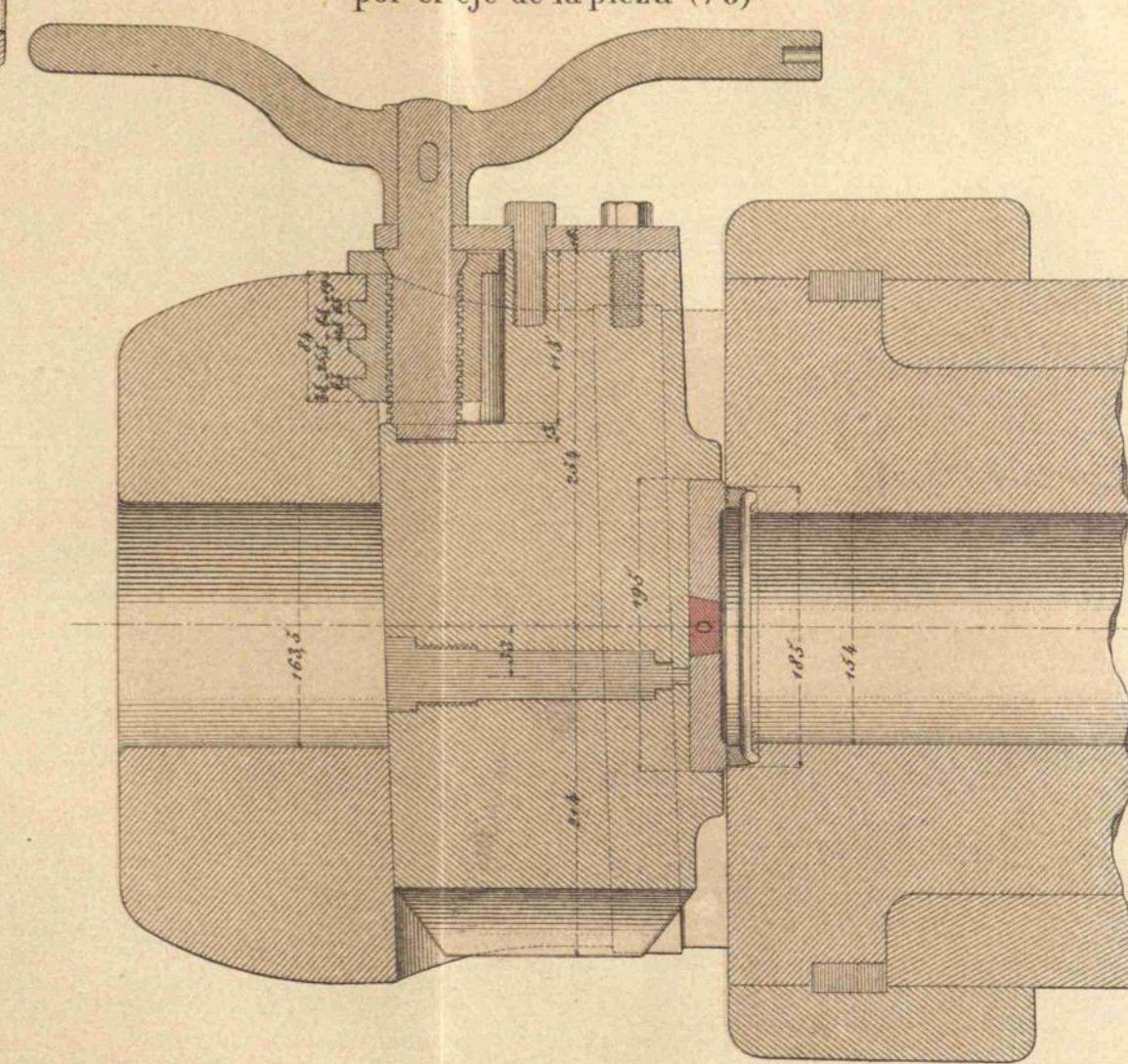
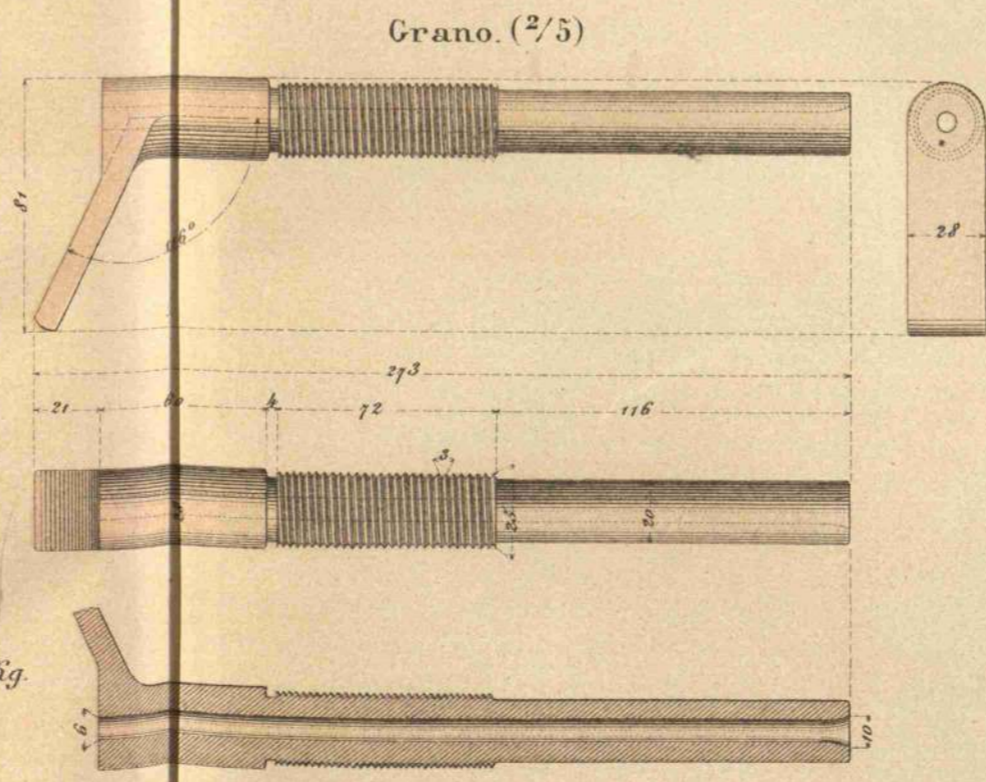



# CAÑÓN DE ACERO DE 15 CARGADO POR LA CULATA.

C. Ac. 15. Cc.

## DETALLES.

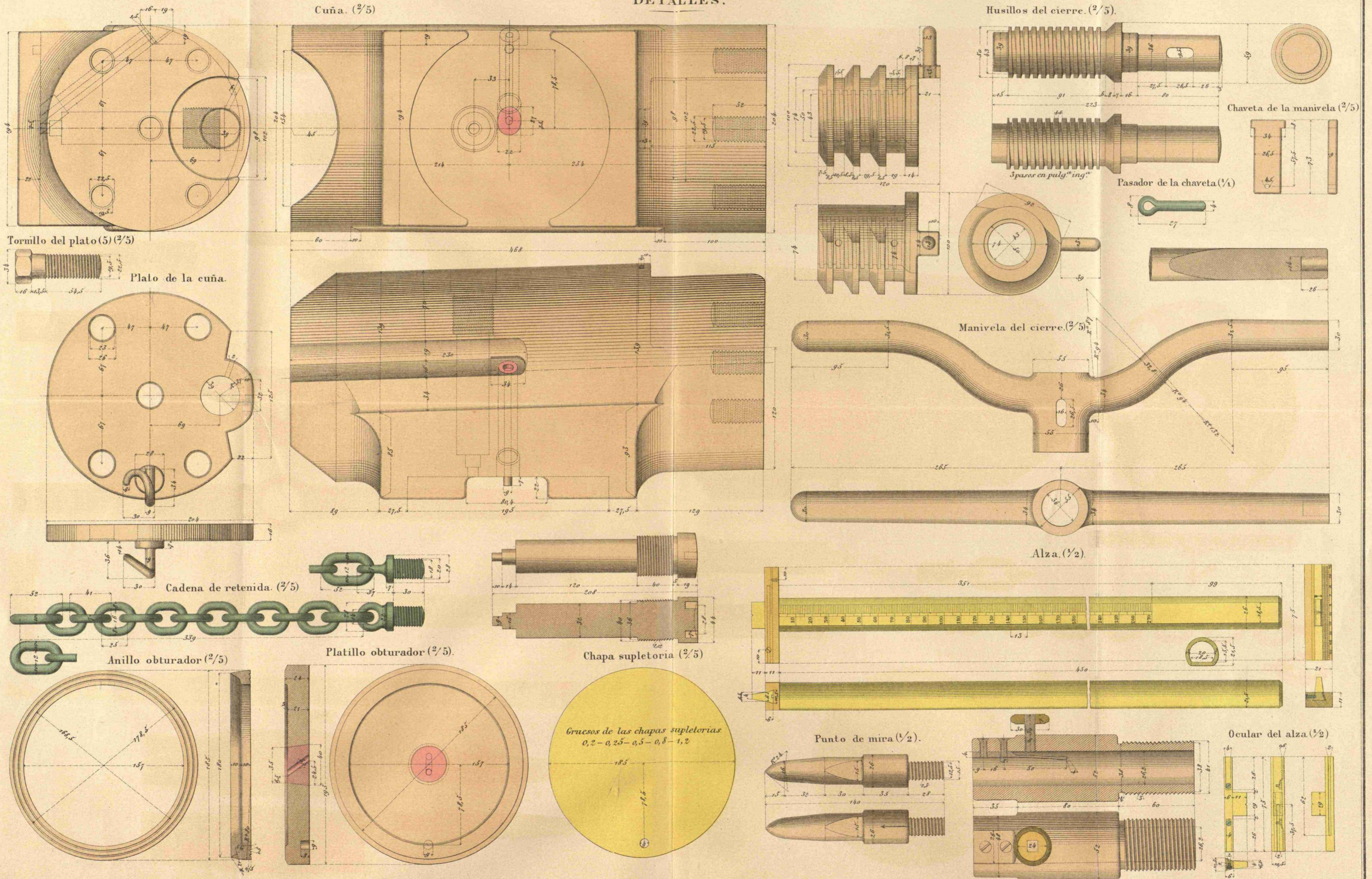



# CAÑÓN DE ACERO DE 8 LARGO CARGADO POR LA CULATA, REFORMADO.

C. Ac. 8. Lr. C.c. Rf.

Linea de mira 808,4

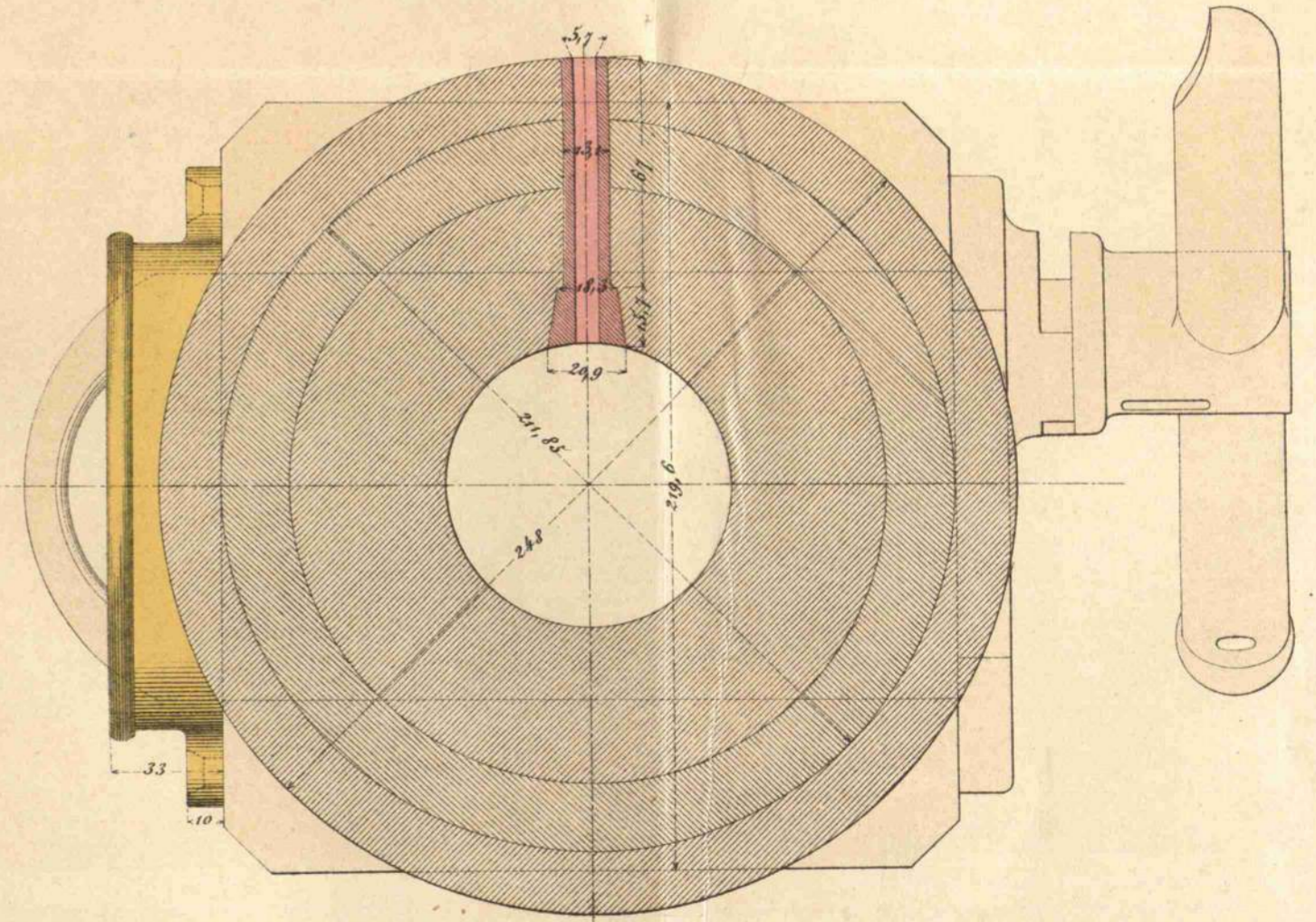
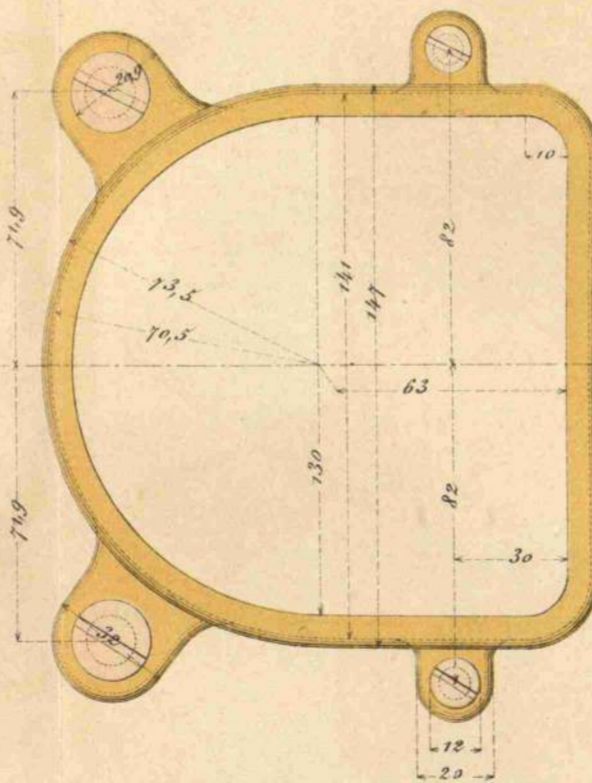
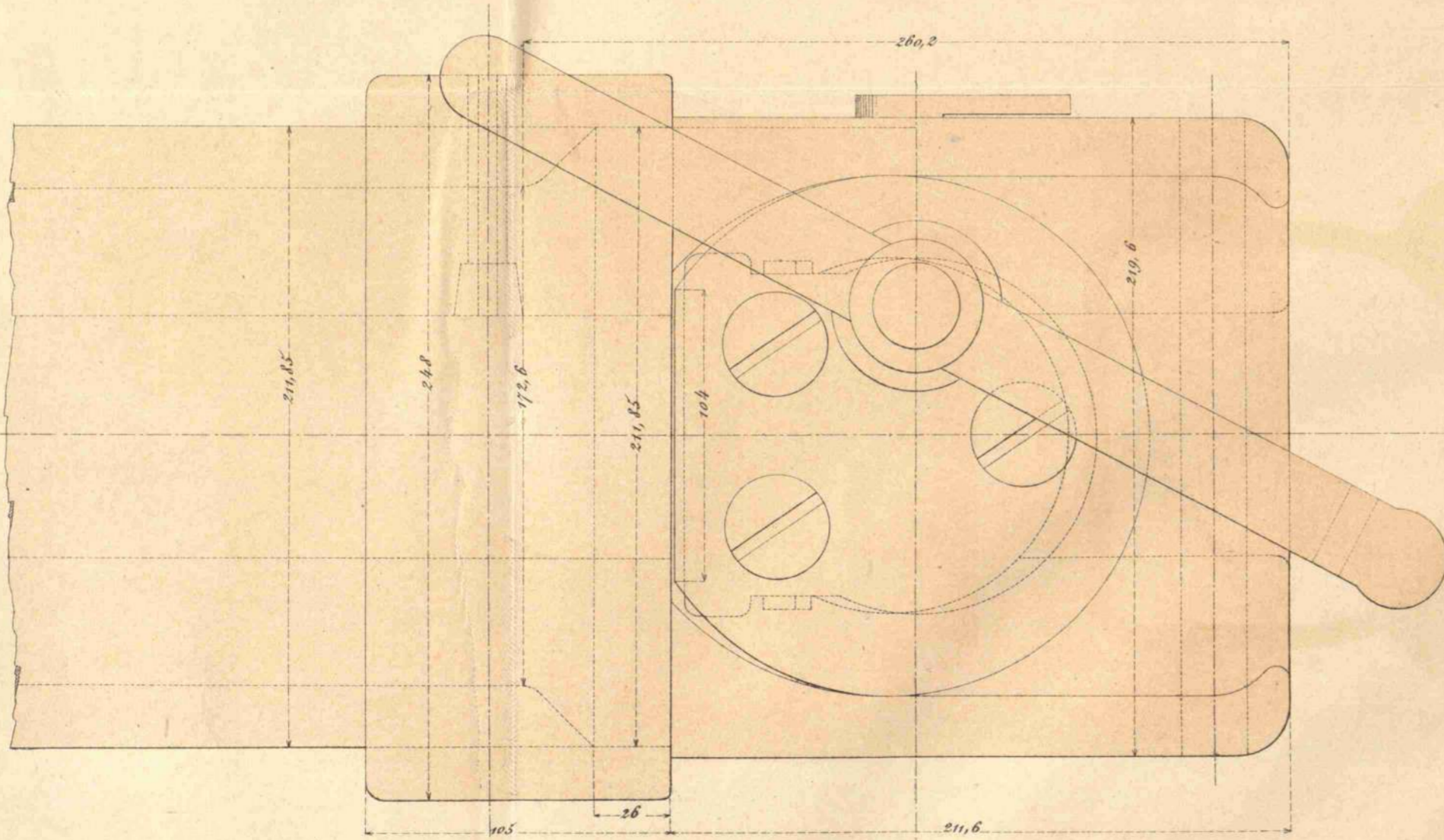
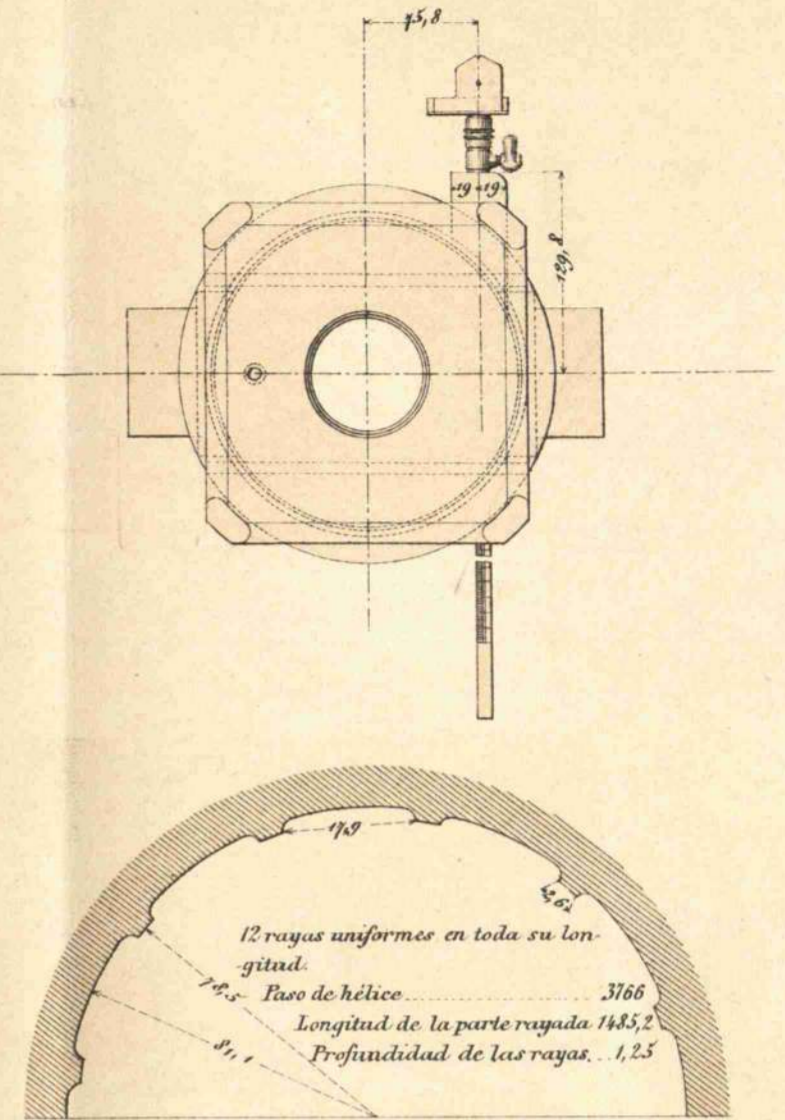
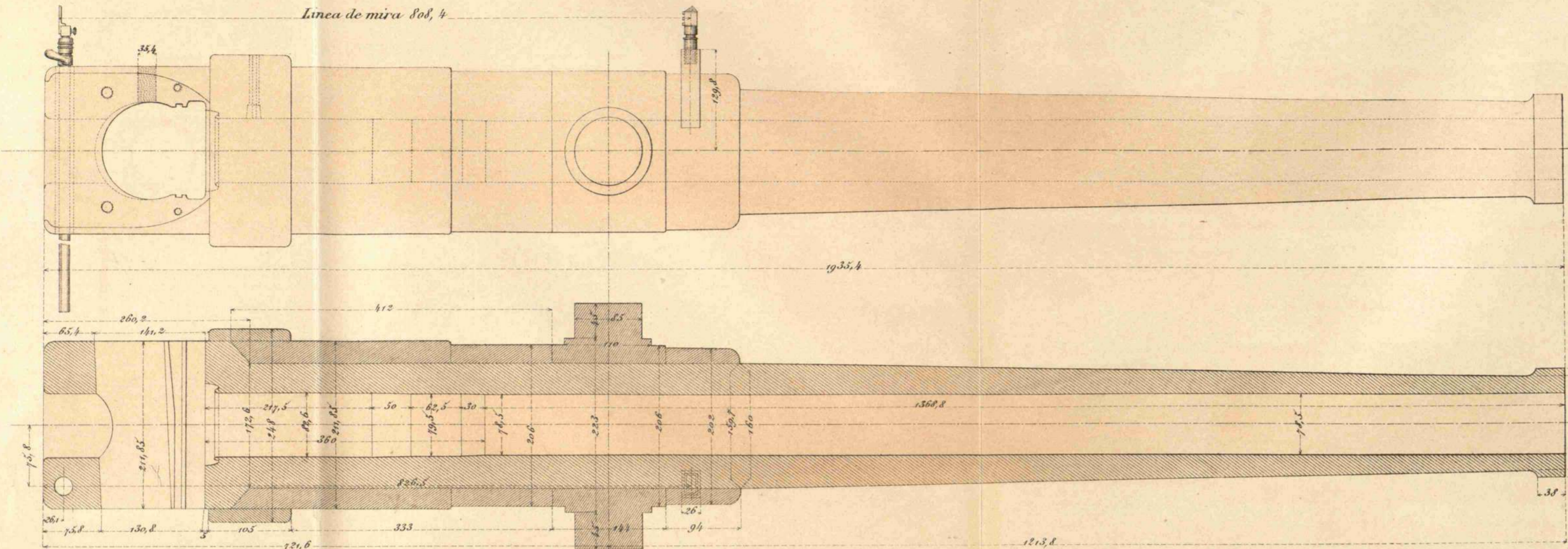

Peso del cañón con cierre  $\frac{Kg.}{338}$   
Preponderancia en el plano de la culata... 37,7

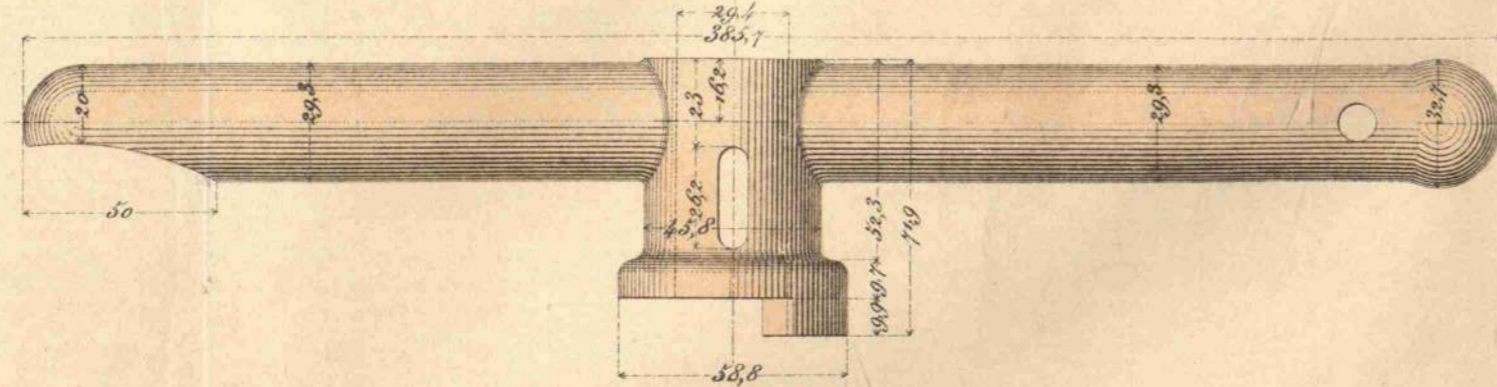

NOTAS. 1<sup>a</sup> La cuña y demás partes que no se detallan, son las mismas que las del C. Ac. Lr. R. & C.c. publicadas en el tomo 3<sup>o</sup> serie A láminas 22 y 23.  
2<sup>a</sup> Los elementos de puntería son iguales en todas sus dimensiones a los del C. B. c. 8. C.c. publicados en el tomo 6<sup>o</sup> serie A lámina 52.  
3<sup>a</sup> Empleando el alza modelo 1868, la longitud de la línea de mira es 800 mm.



# CAÑÓN DE HIERRO SUNCHADO DE 24 CARGADO POR LA CULATA MODELO 1884.

C. H. S. 24. Cc. Md. 1884.

Escala 1/15

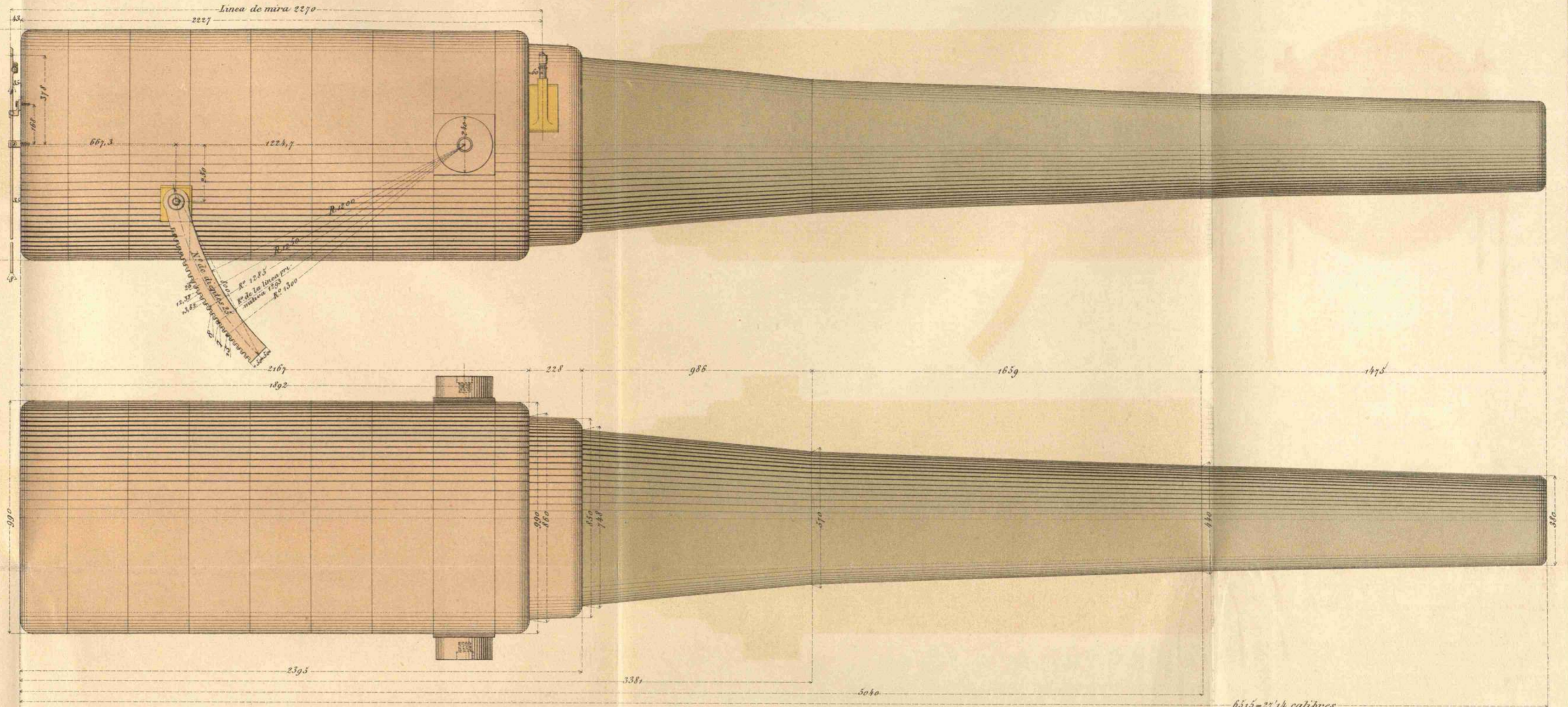
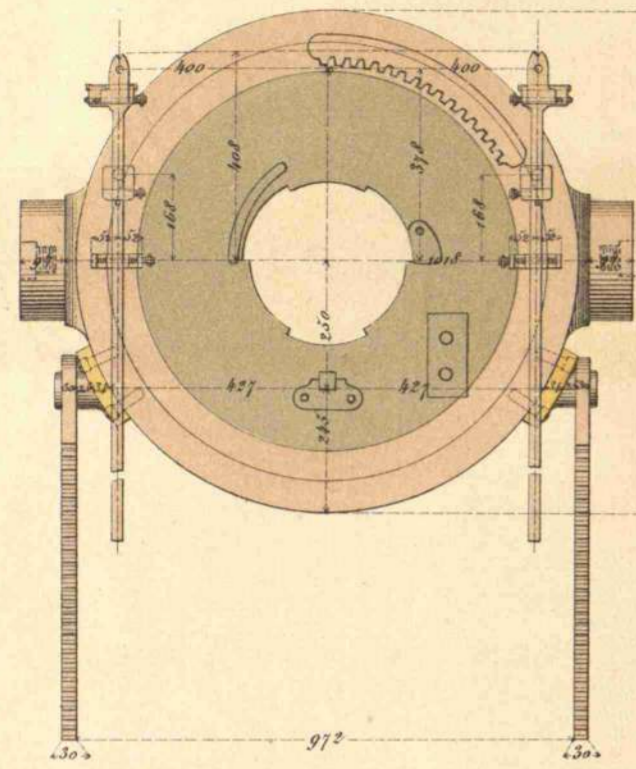

Peso del cañón..... 17,500 Kg.

Preponderancia..... 0

Volumen de la recámara..... 44536 cm<sup>3</sup>

Ecuación de la parábola que empieza con la inclinación de 30° y termina en 5° 21'

$$S = 0,000008055x^2 + 0,00873x.$$

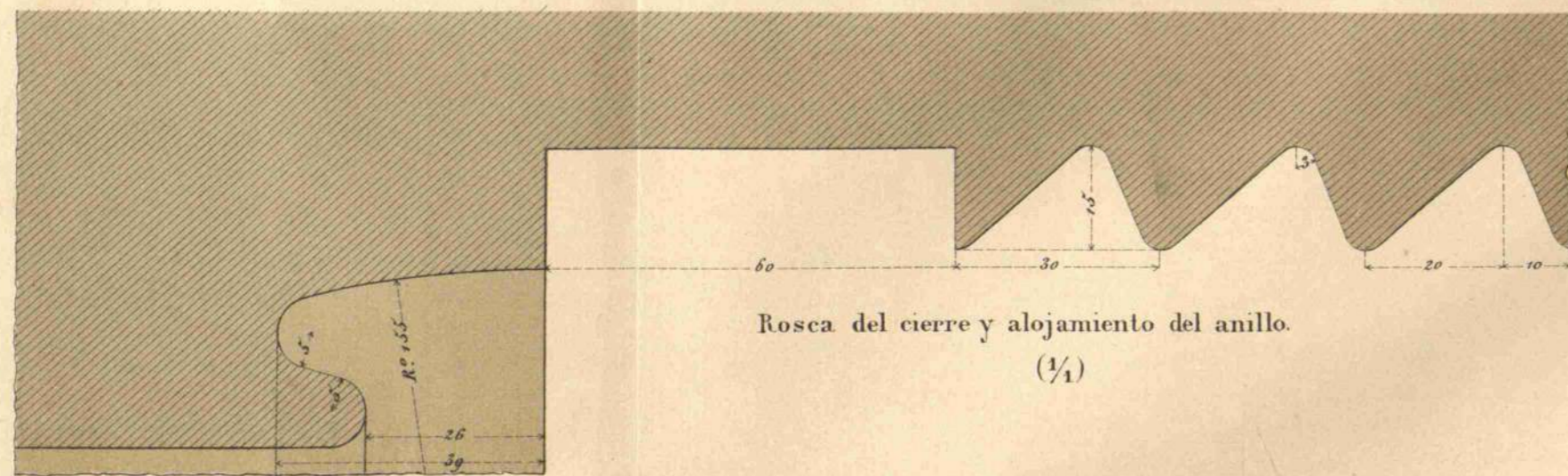
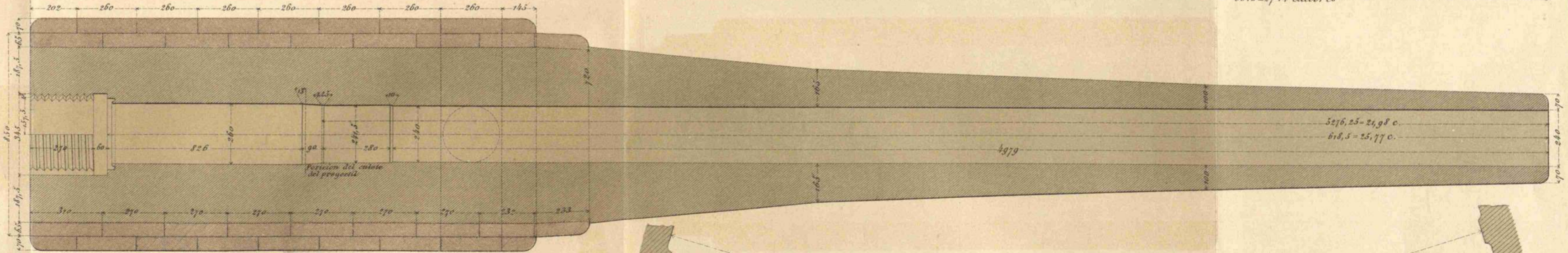

Rosca del cierre y alojamiento del anillo (1/1)

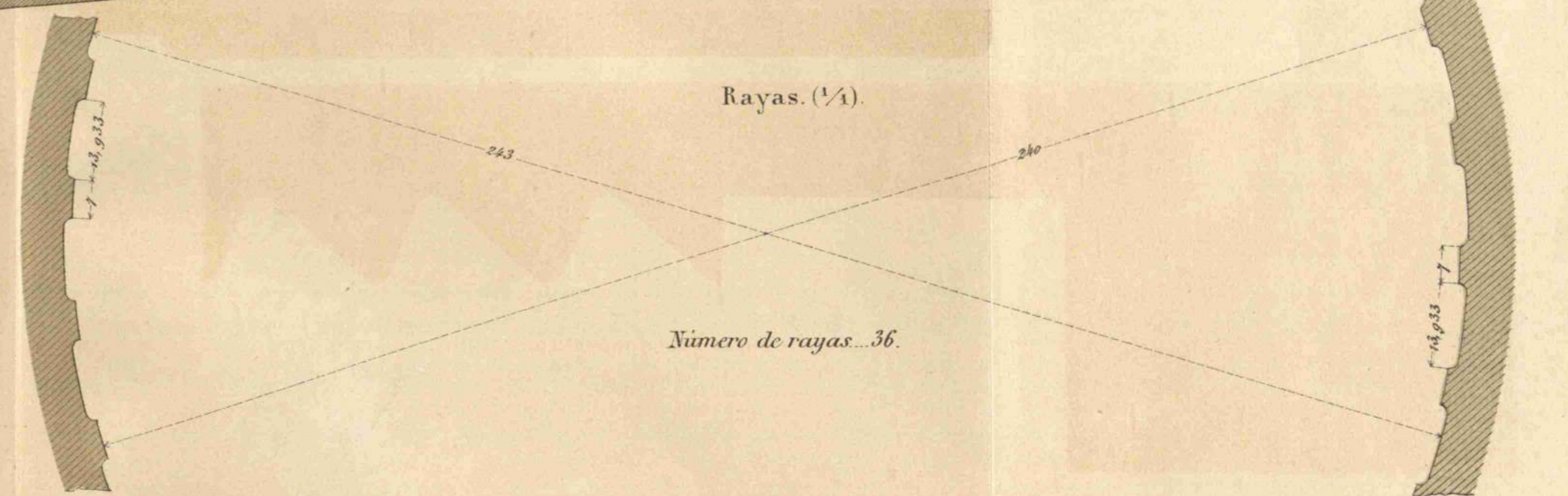

Rayas. (1/1)

Número de rayas...36.



# CAÑÓN DE HIERRO SUNCHADO DE 24 CARGADO POR LA CULATA MODELO 1884.

C. H. S. 24 Cc. Md. 1884.

DETALLES.

Escala  $\frac{3}{10}$

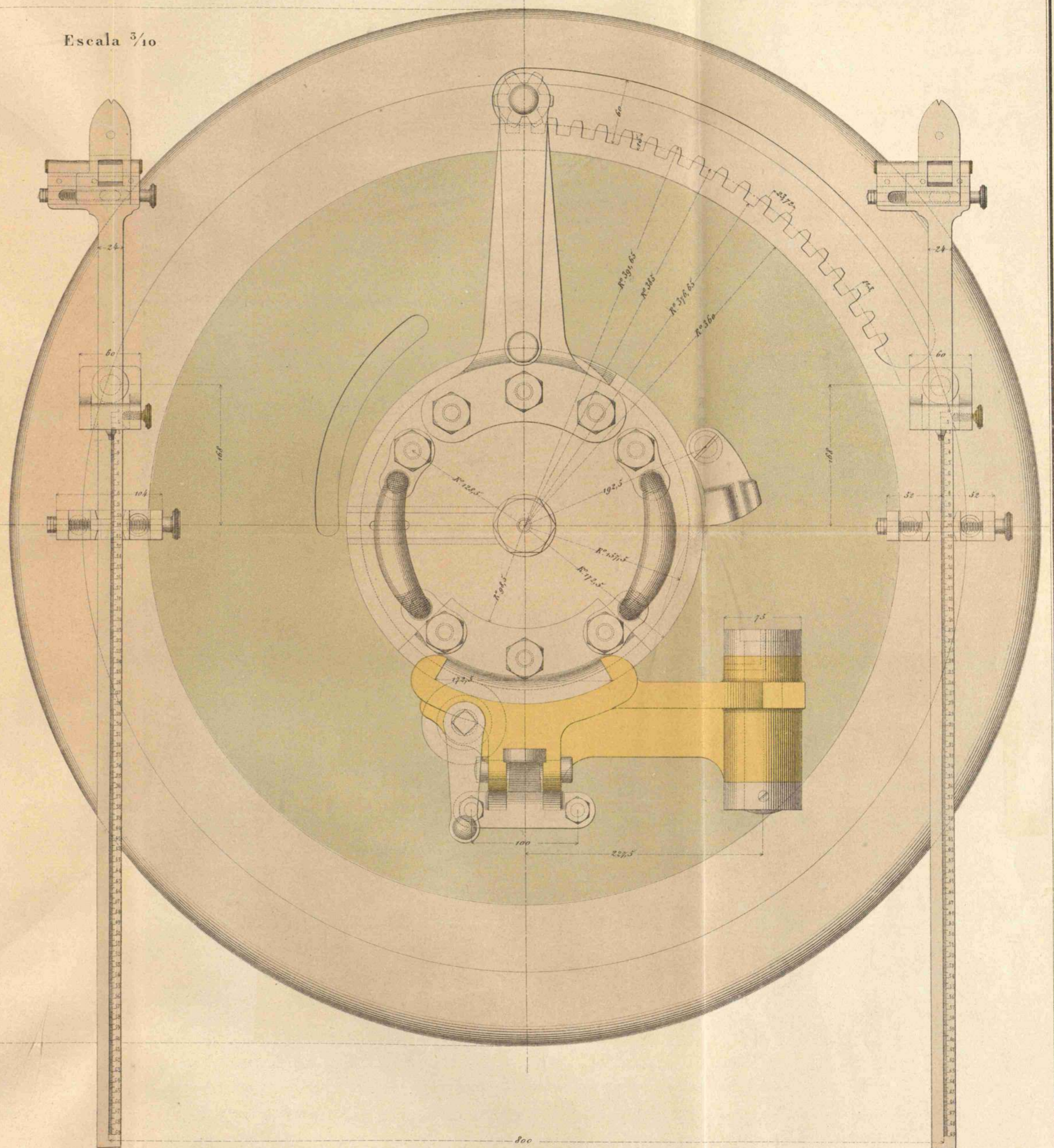
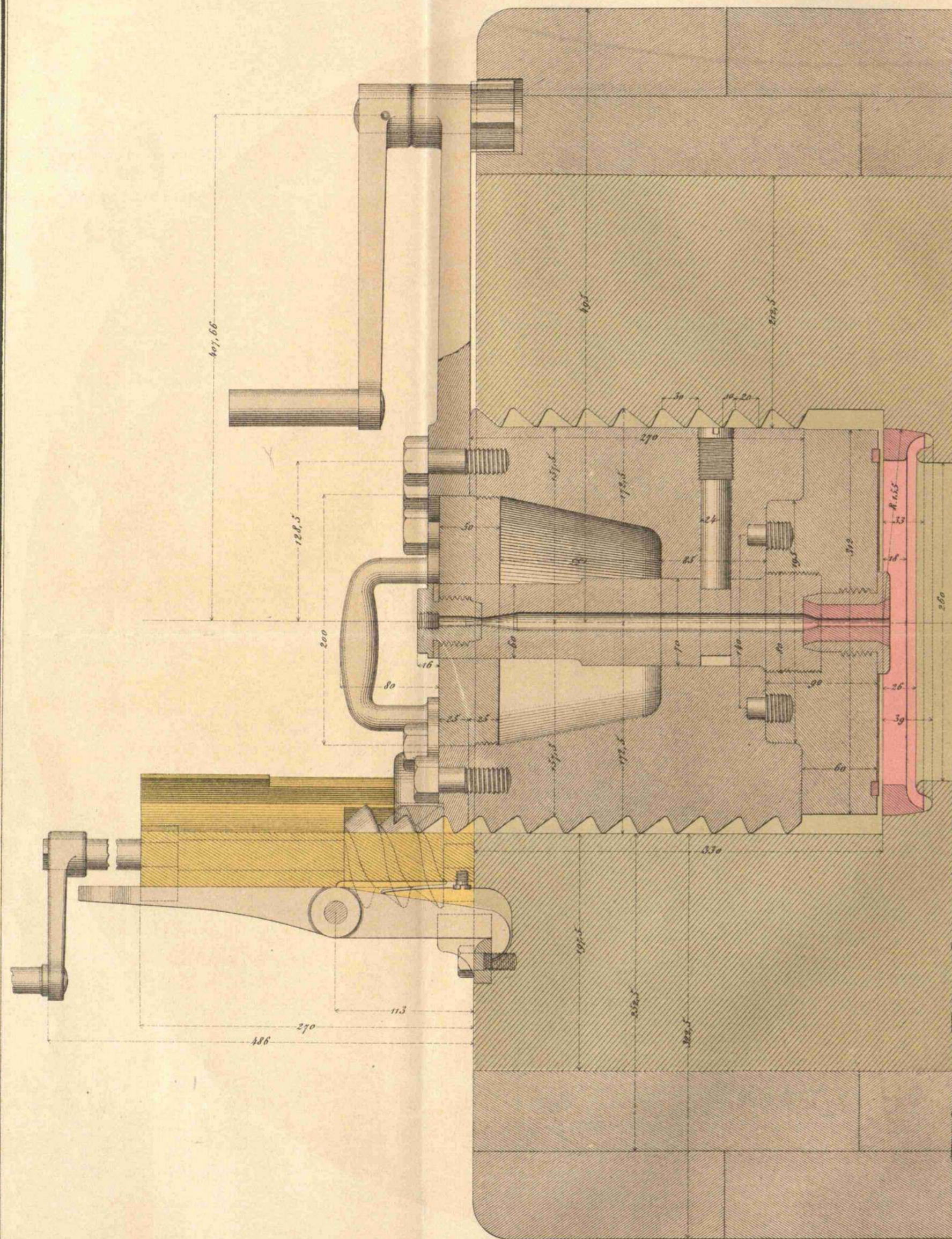



# CAÑÓN DE HIERRO SUNCHADO DE 24 CARCADO POR LA CULATA MODELO 1884.

C. H. S. 24. Cc. Md. 1884.

## DETALLES.

Tornillo de cierre (3/10)

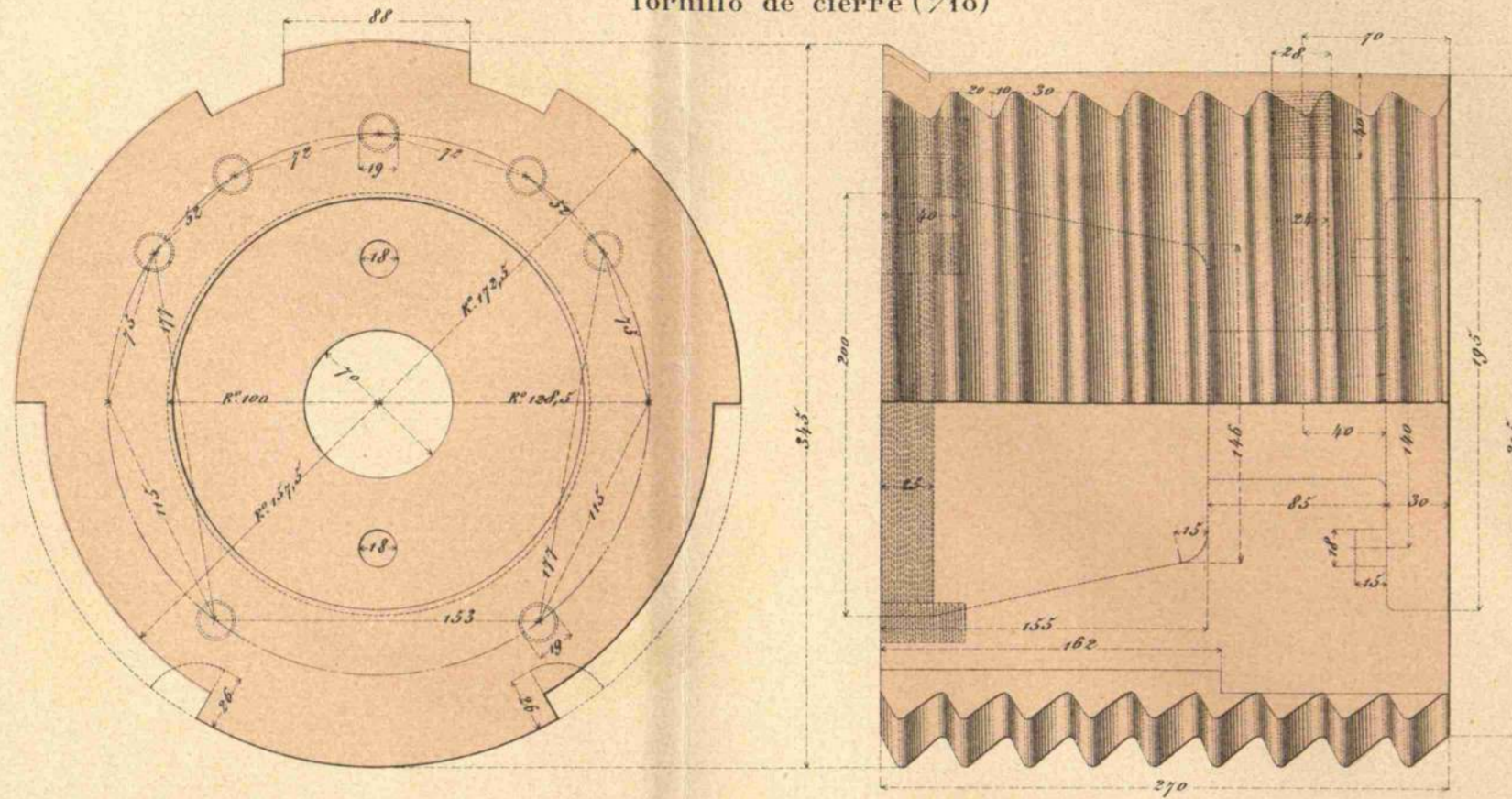

Platillo obturador (3/10)

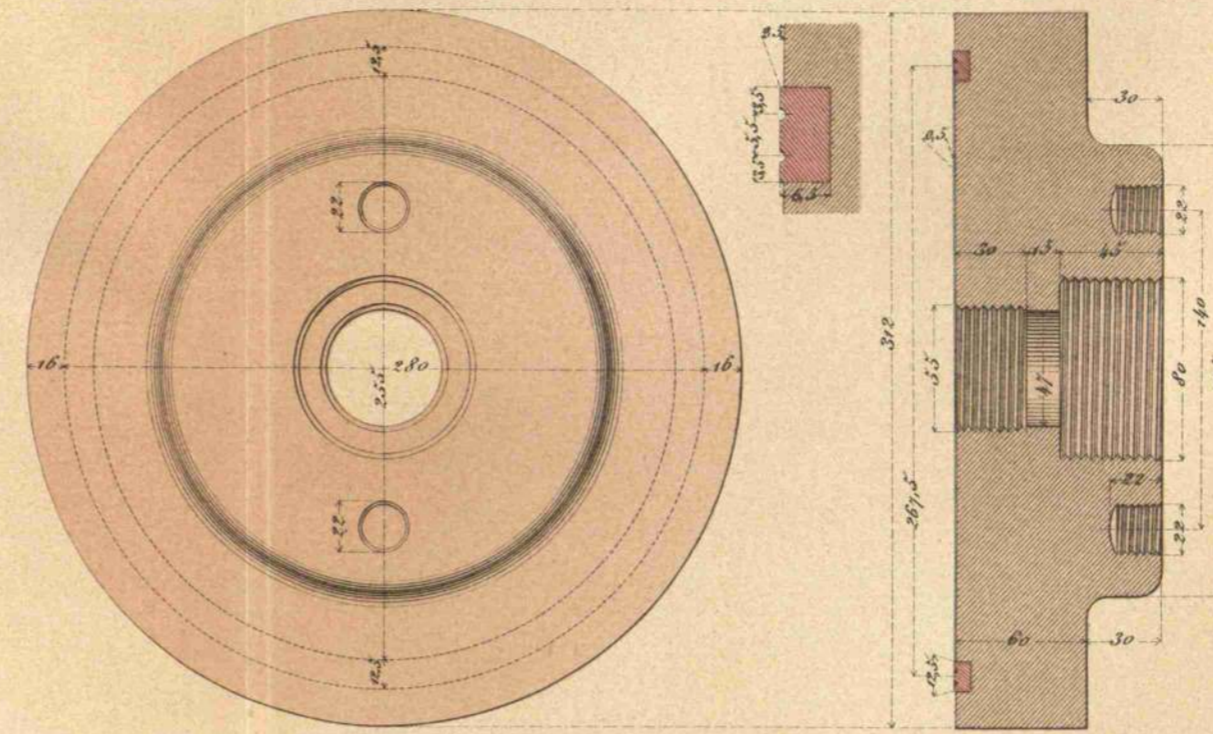

Anillo obturador (3/10)

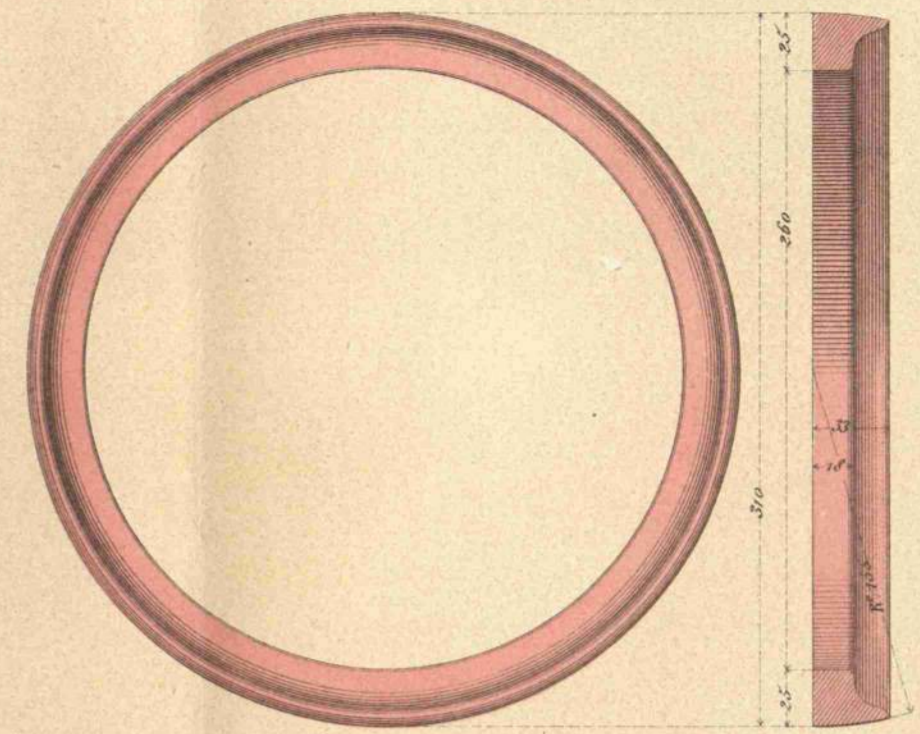

Platillo anterior (3/10)

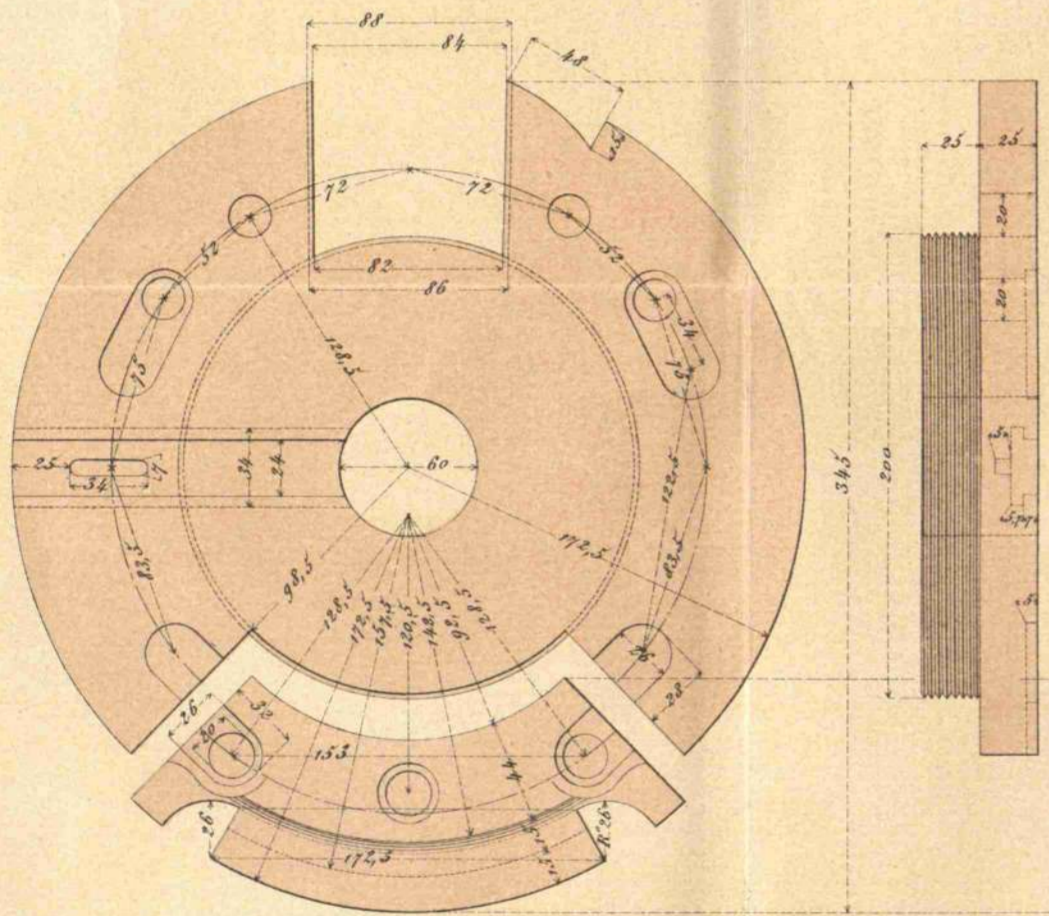

Tornillo para fijar el platillo obturador (2/5)



Vástago del platillo obturador (2/5)

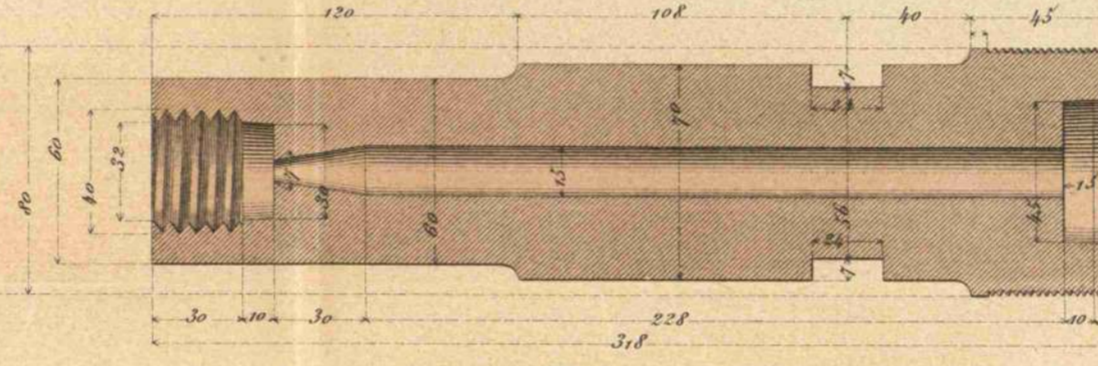

Tornillo de retención del vástago del platillo (2/10)



Tornillo del platillo exterior (8) (2/5)

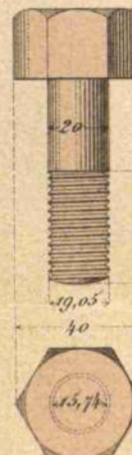

Asa del cierre (2) (2/5)

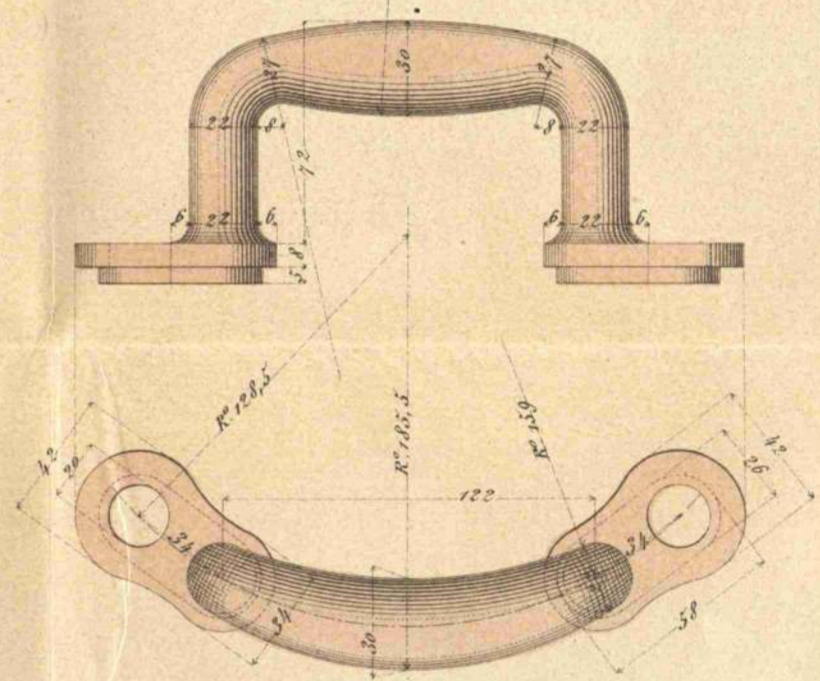

Seguro de cierre (2/5)

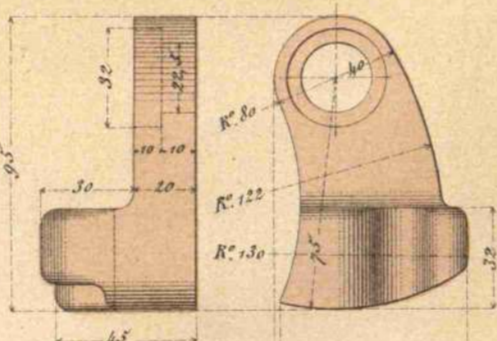

Corredera tapa-fojon (2/5)

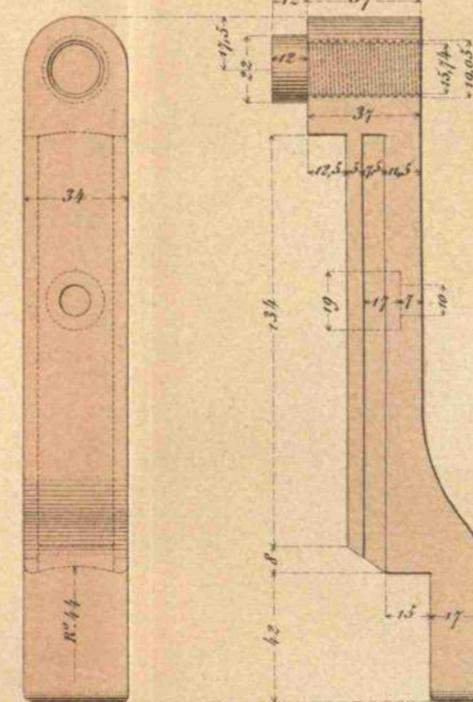

Palanca de cierre (2/5)

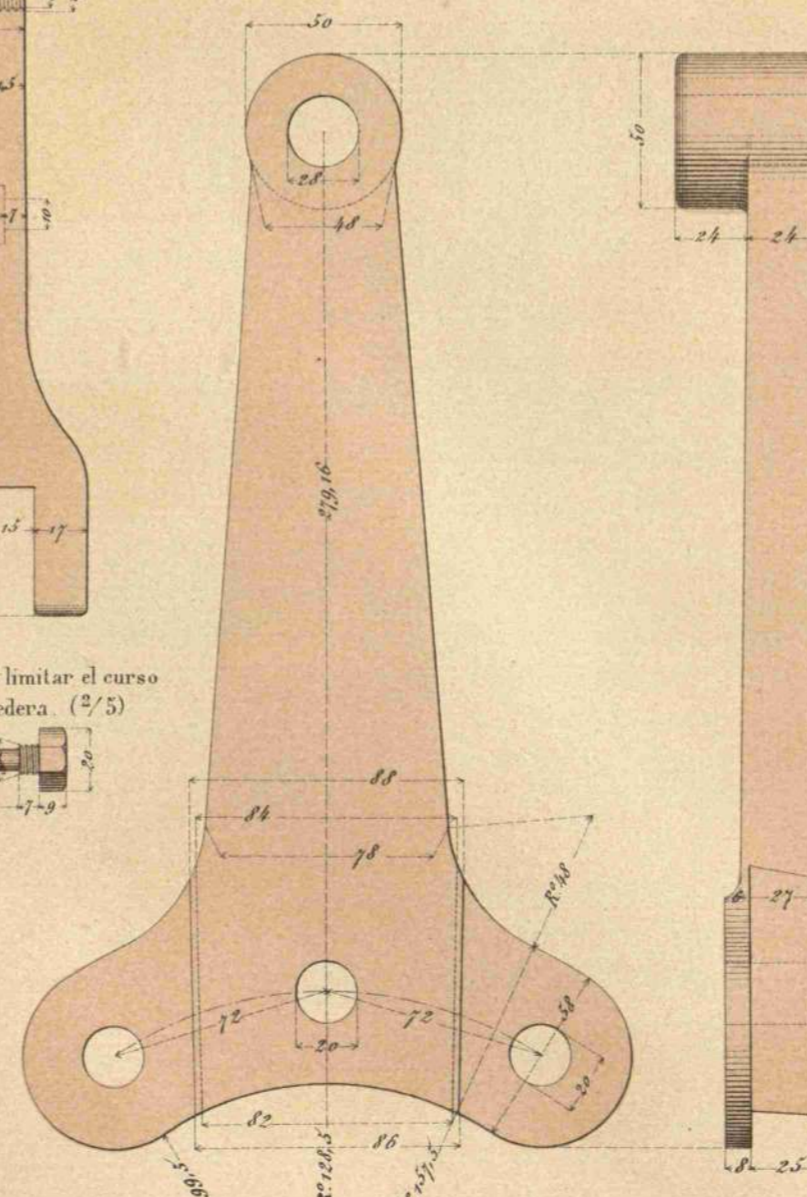

Manubrio (2/5)

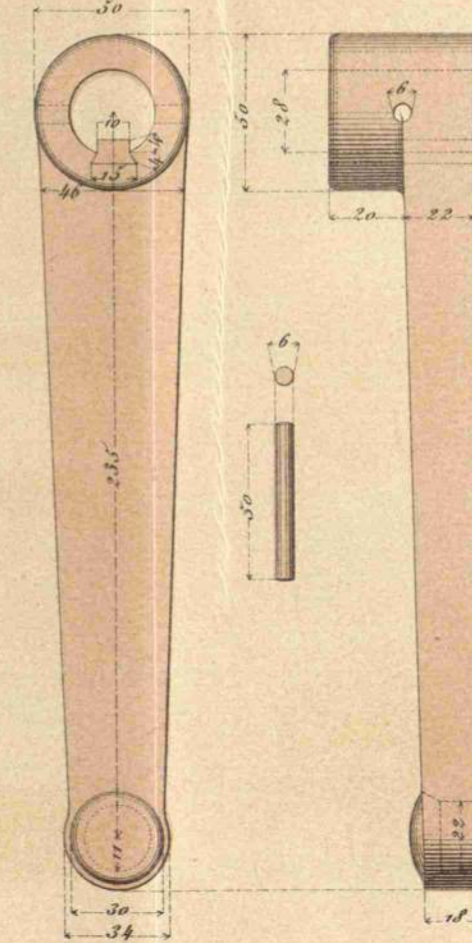

Engrane (2/5)

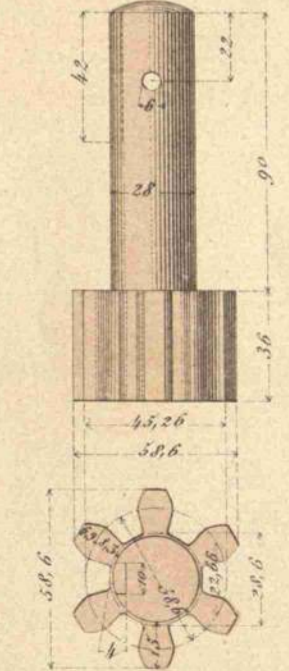

Boquilla para estopín obturador (2/5)

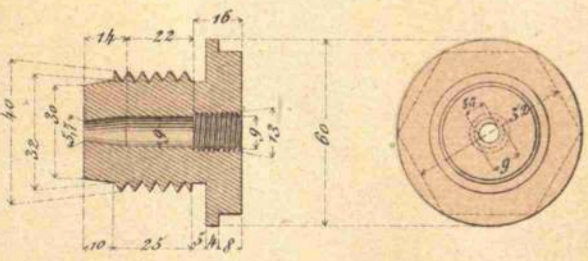

Estopín obturador de fricción Md. provisional de 1885 (1/2)

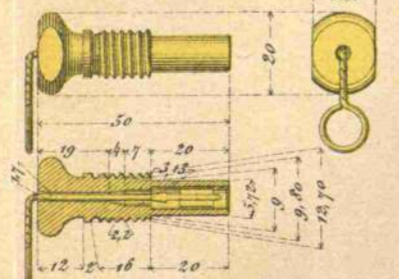

Boquilla para estopín de fricción (2/5)

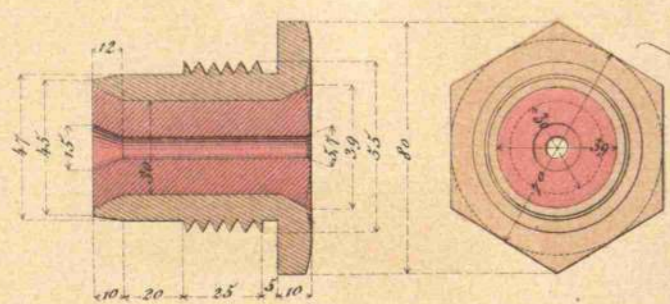

Boquilla del platillo obturador.

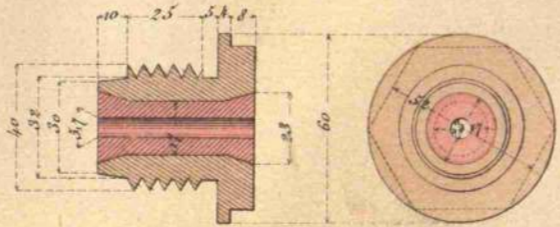

Volandera del torn. de la corredera (2/5)



Muelle de la corredera (2/5)

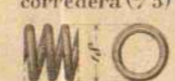

Tornillo p.º limitar el curso de la corredera (2/5)

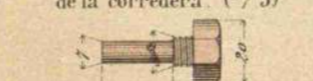

Volandera para la boquilla del platillo obturador (2/5)

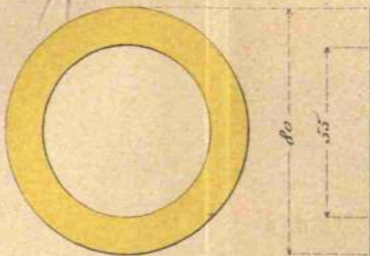



# CAÑÓN DE HIERRO SUNCHADO DE 24 CARGADO POR LA CULATA MODELO 1884.

C. H. S. 24. Cc. Md. 1884.

## DETALLES.

Teja porta-tornillo (3/10)

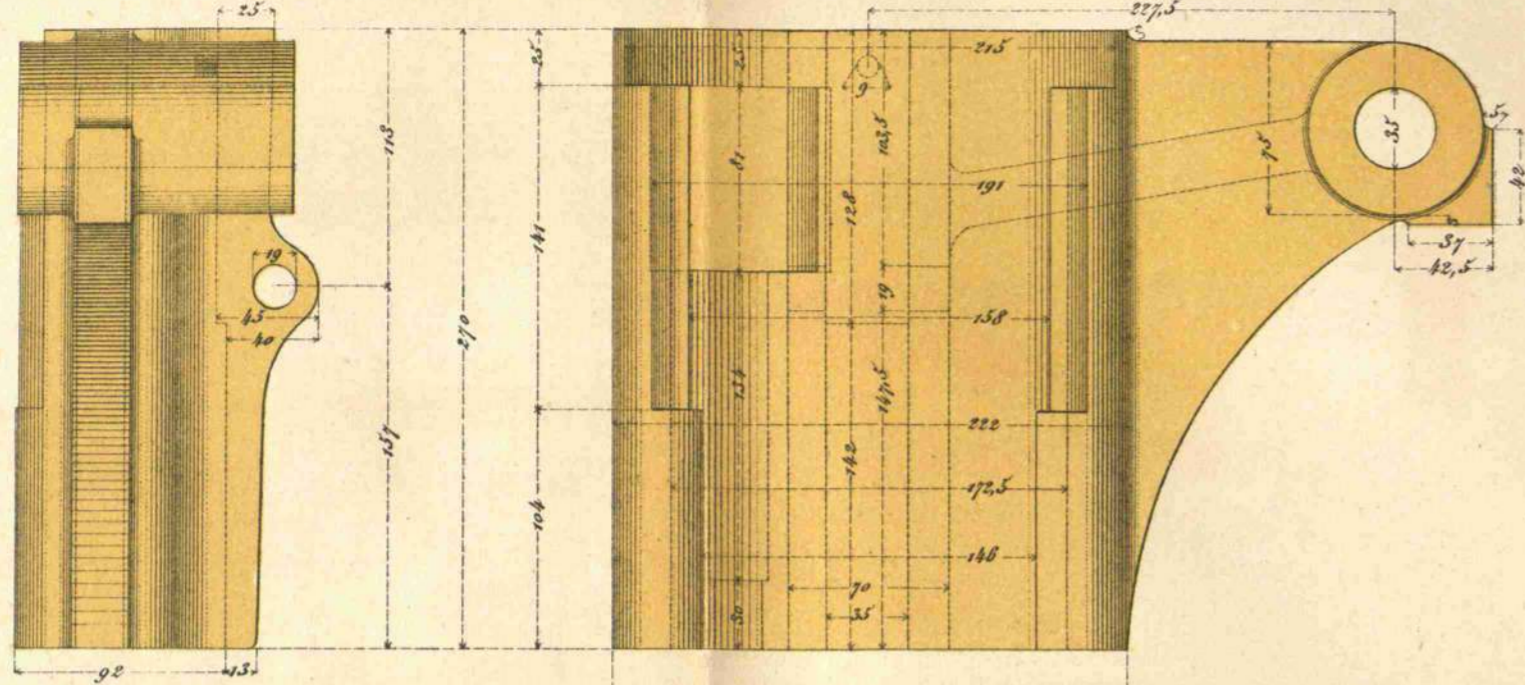

Soporte lateral de la teja (2/5)

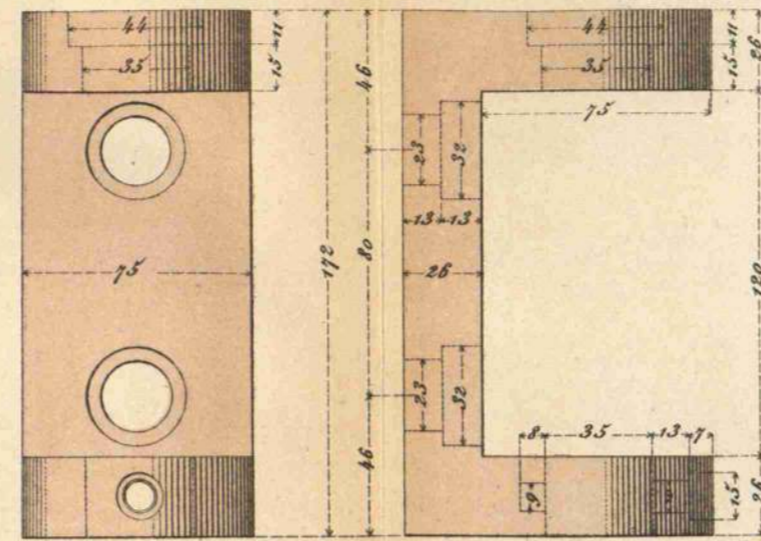

Soporte inferior de la teja (2/5)

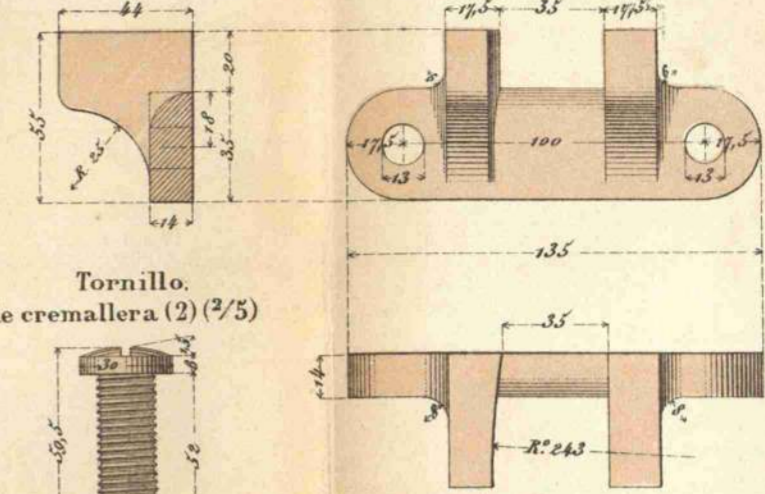

Tornillo del soporte lateral (2)(2/5)

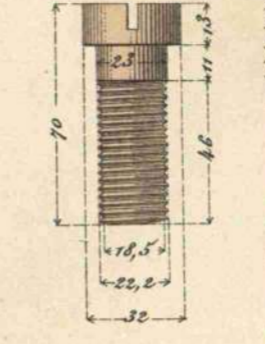

Tornillo de cremallera (2)(2/5)

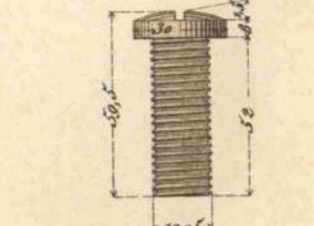

Tornillo del soporte inferior (2)(2/5)

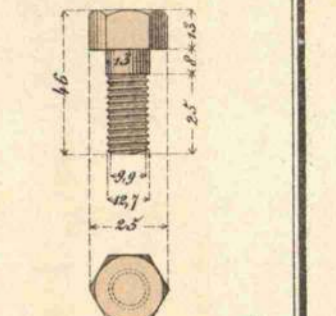

Soporte de cremallera (2)(2/5)

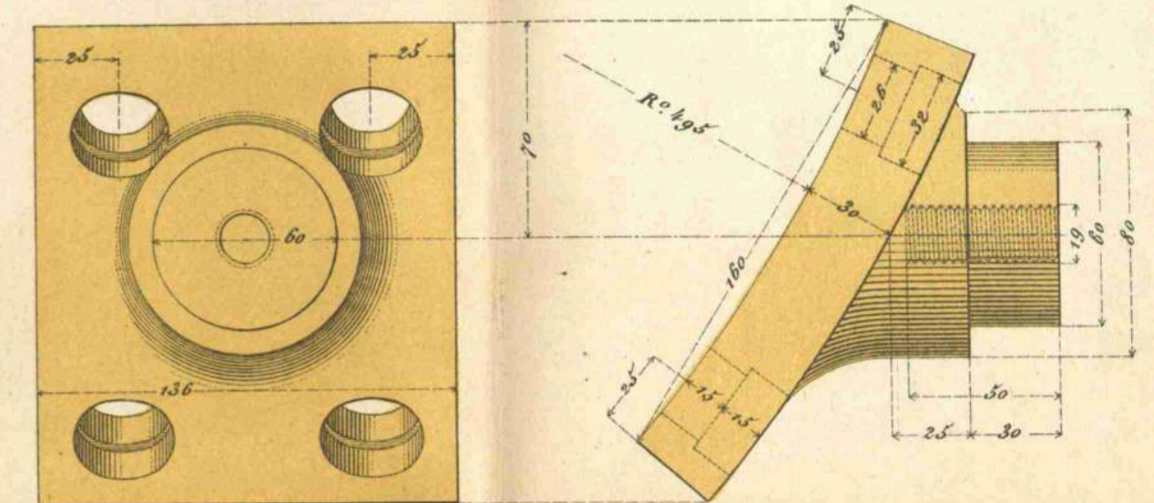

Palanca fiador de la teja (2/5)

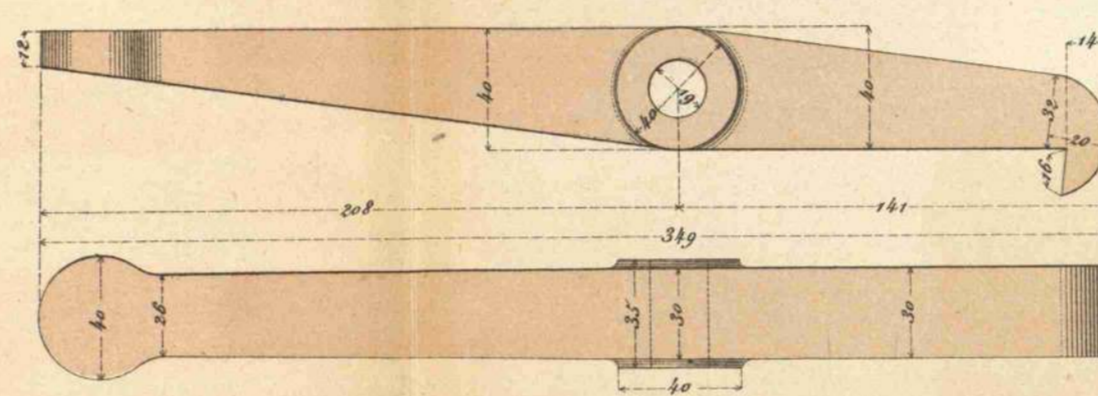

Muelle de la palanca fiador (2/5)

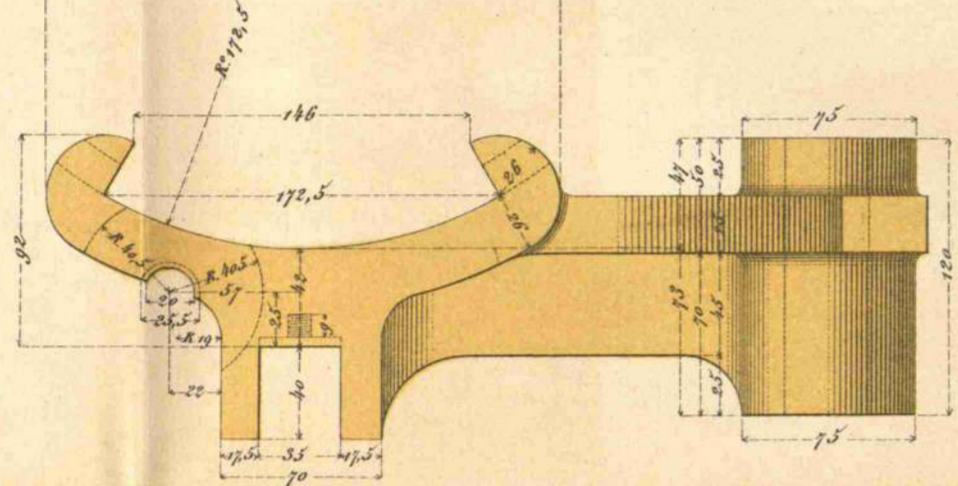
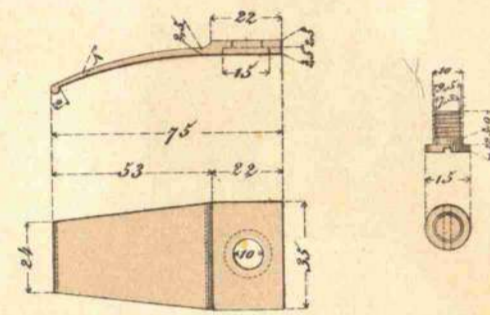

Tornillo de sujecion del eje de la teja (2/5)

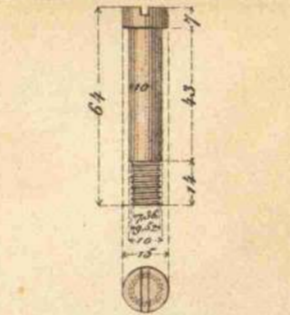

Pasador eje del fiador (2/5)

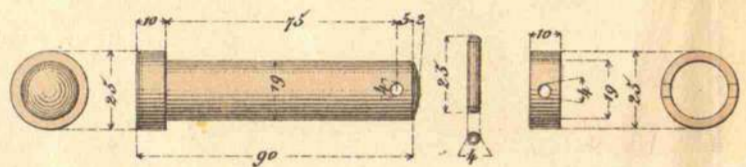

Pasador eje de la teja (2/5)

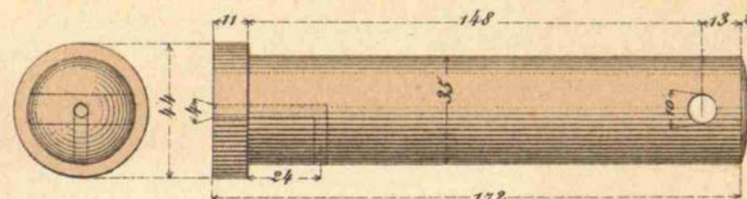

Husillo extractor del cierre (2/5)

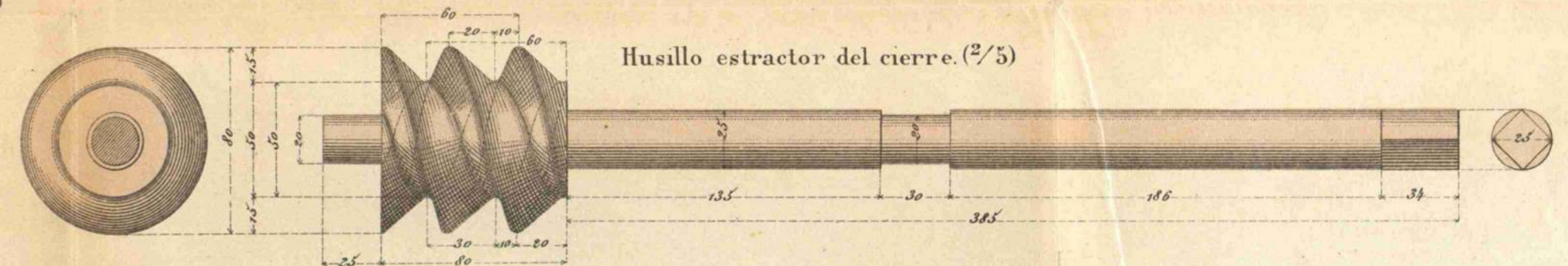

Aparato de suspension del cañon (1/10)

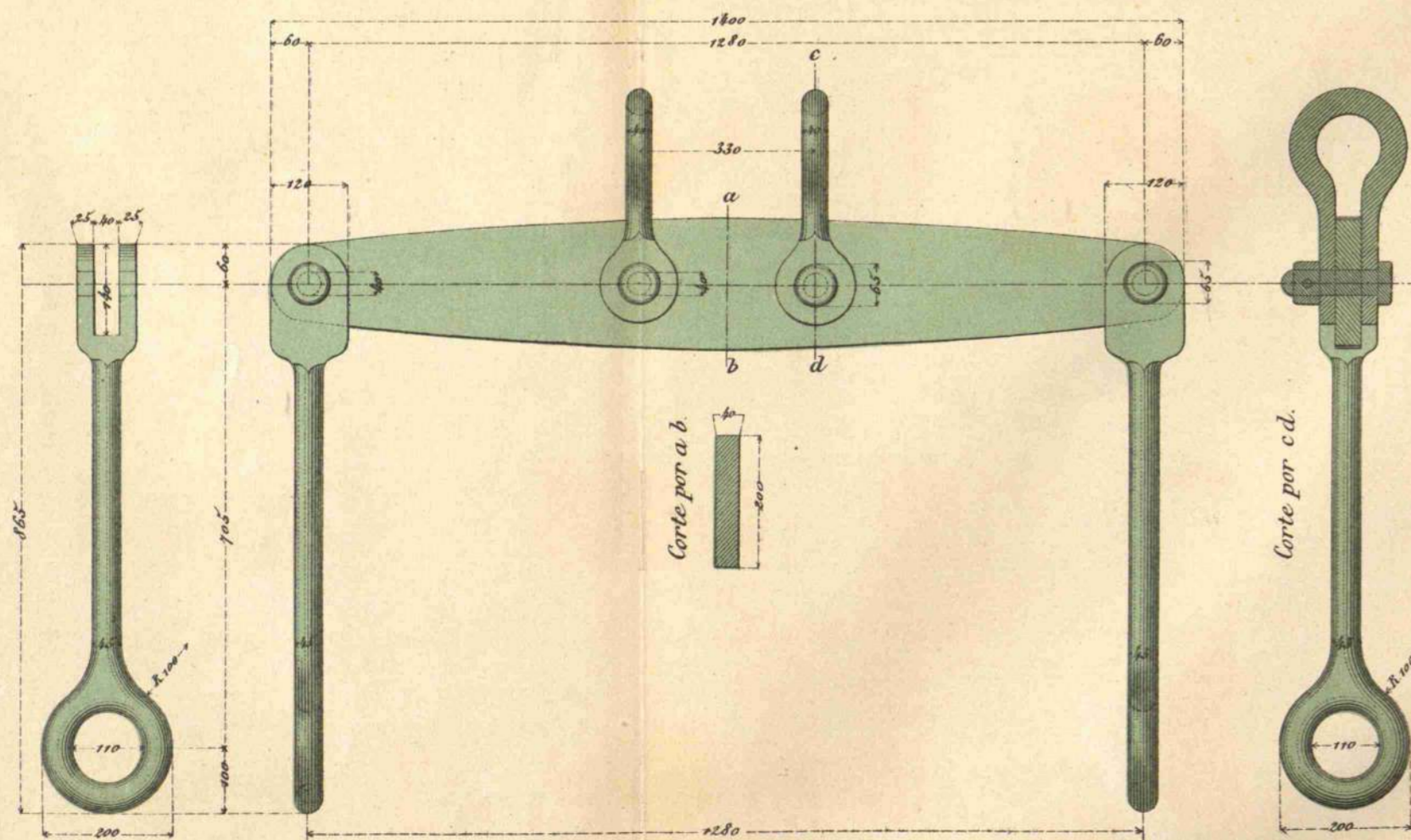

Argillon del aparato de suspension (2)(1/5)

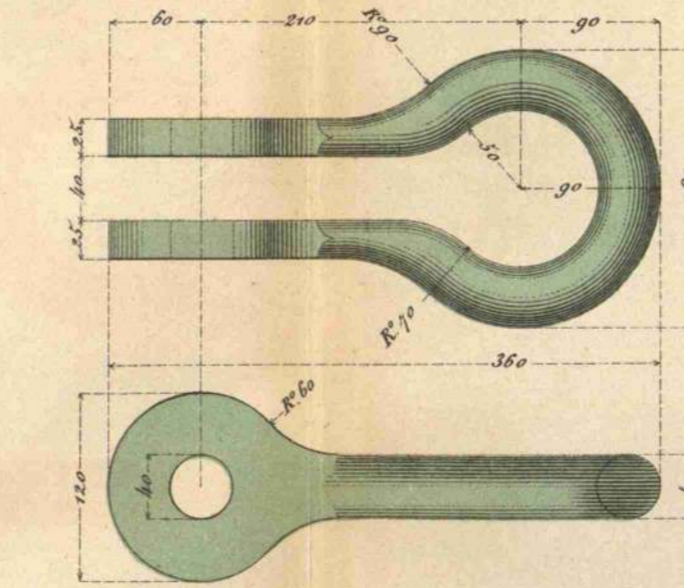

Volandera del soporte de cremallera (2)(2/5)

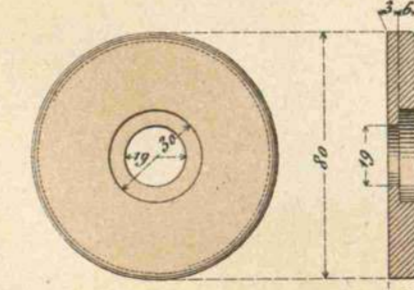

Soportes del husillo extractor (1/2)

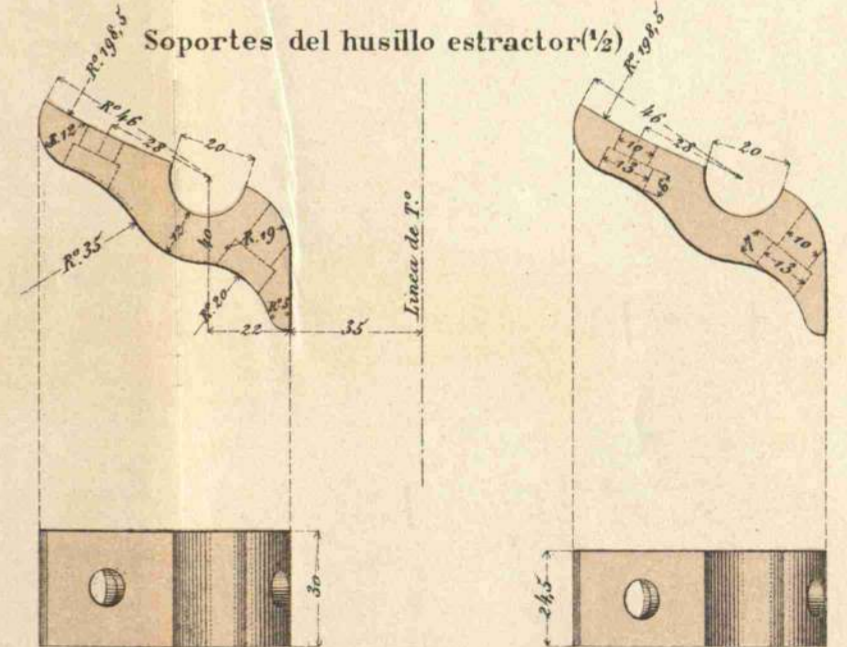

Manivela del extractor (2/5)

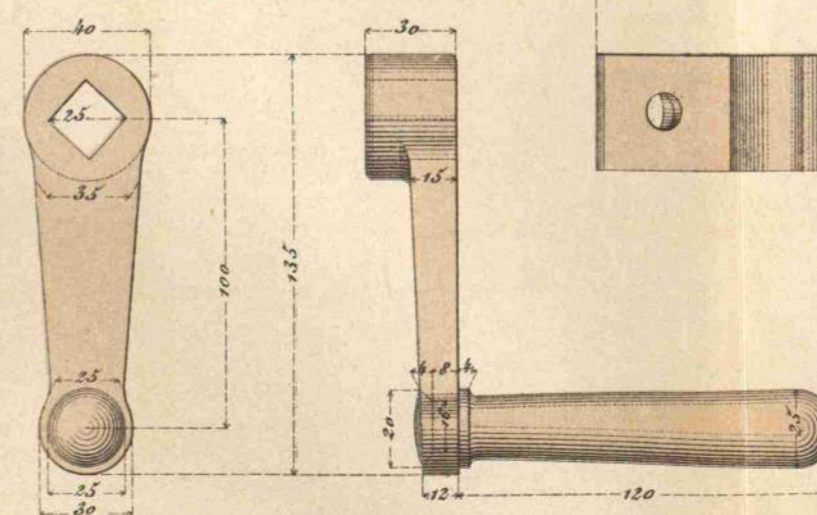

Pasador del tirante y argillon (4)(1/5)



Muñon de maniobra (2)(1/5)

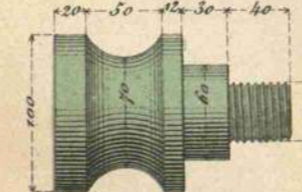

Tornillos del soporte del extractor (1/2)





# CAÑÓN DE HIERRO SUNCHADO DE 24 CARGADO POR LA CULATA MODELO 1884.

C. H. S. 24. Cc. Md. 1884.

## ALZA Y PUNTO DE MIRA.

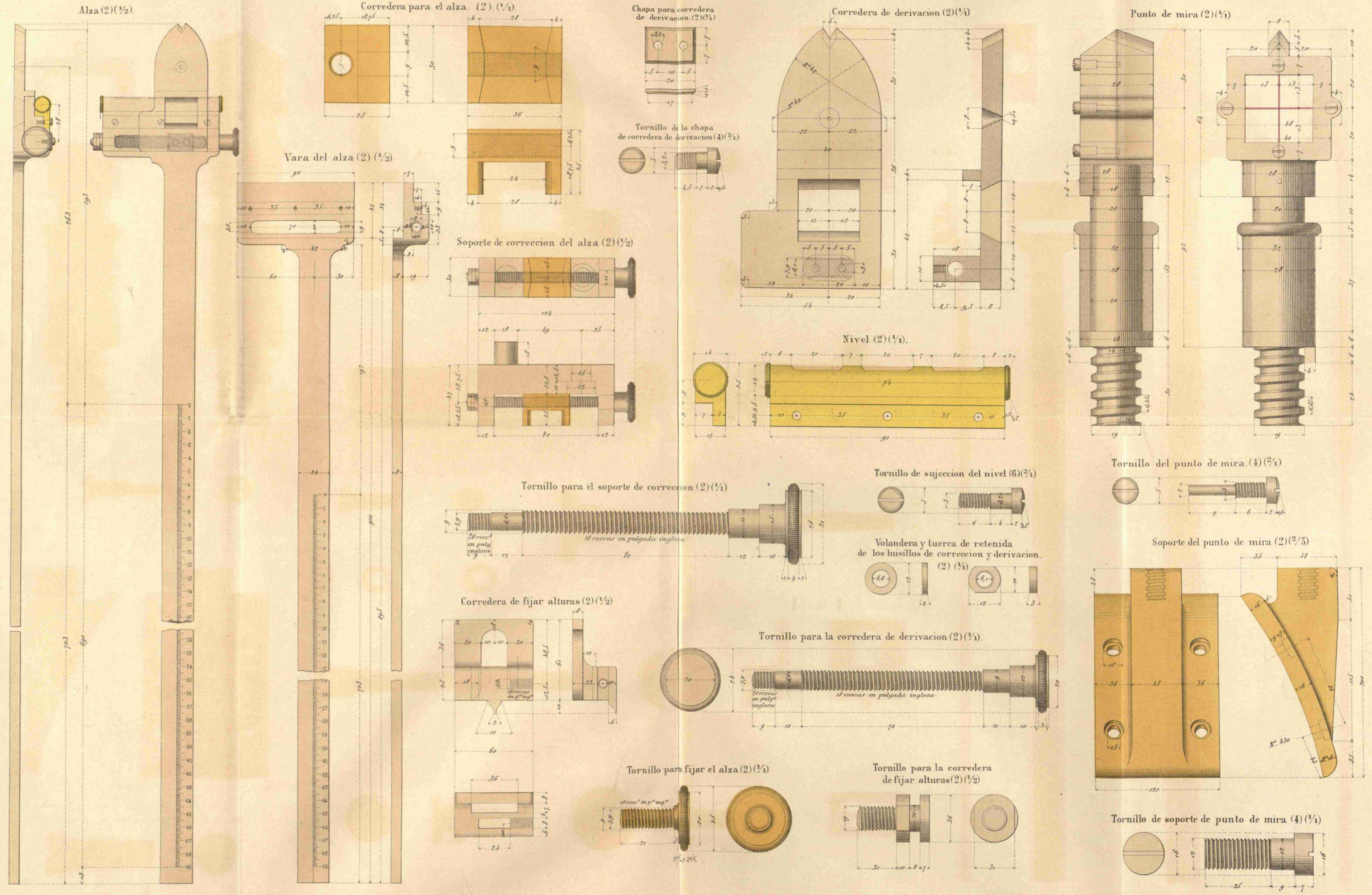



# GRANADAS PARA C. H. 24.Cc.

Ordinaria (2/5)

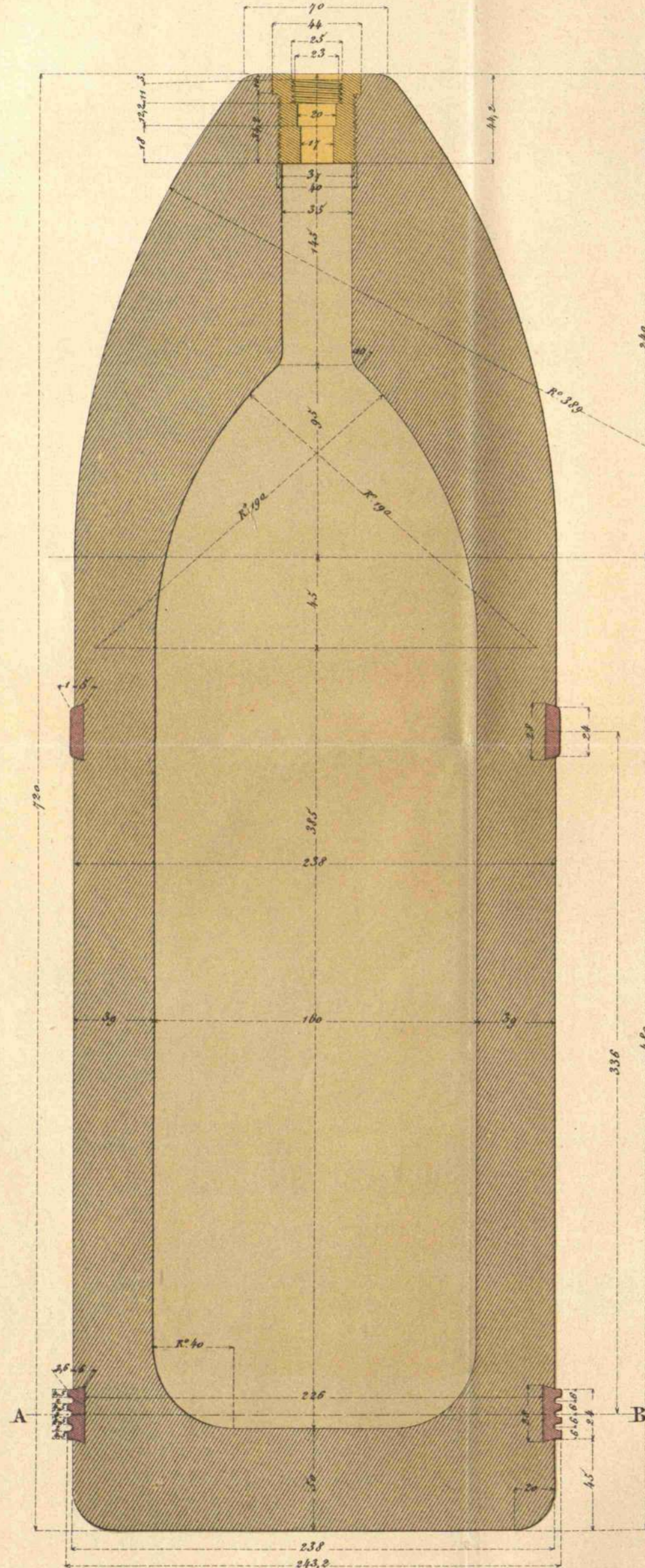

Peso de la granada vacía ..... Kg. 134,785 ± 1,35  
 Id. .... id. cargada ..... „ 144

Anillo de conducción (1/1)

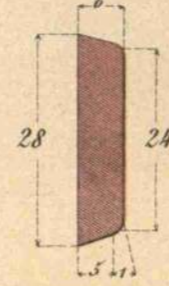

Anillo de forzamiento.

Ordinaria.

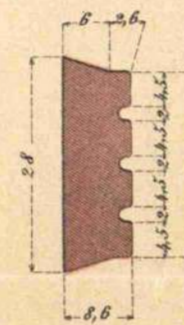

Perforante.

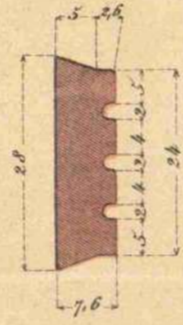

Corte por A.B.

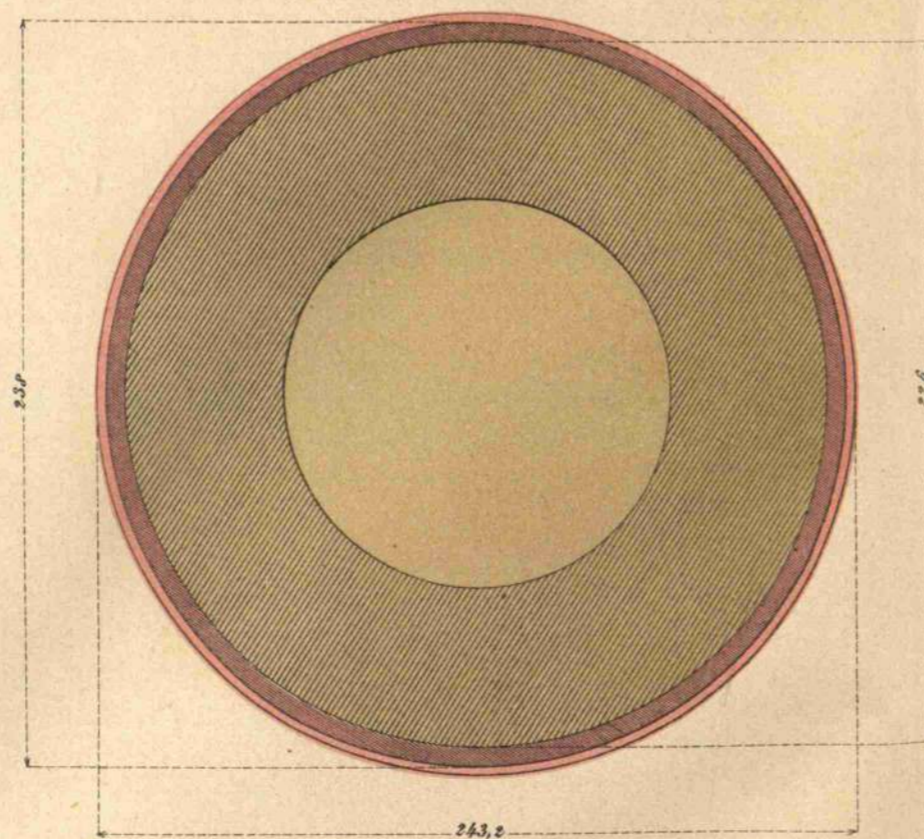

(1/1)

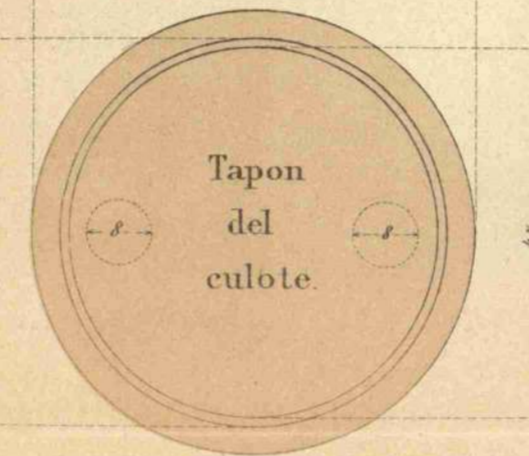
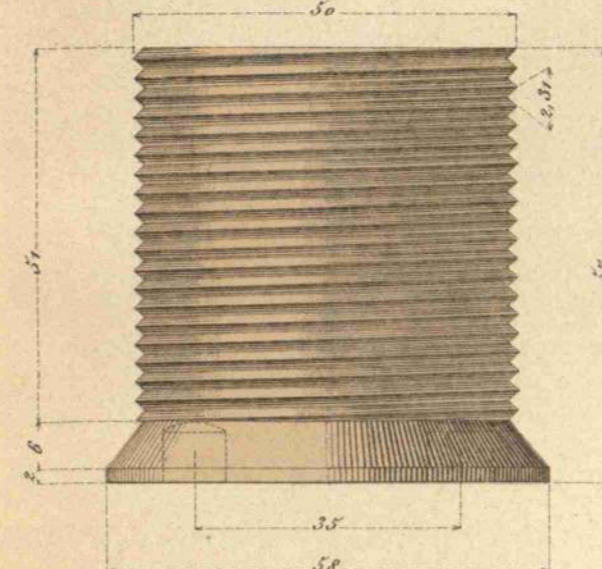

Corte por C.D.

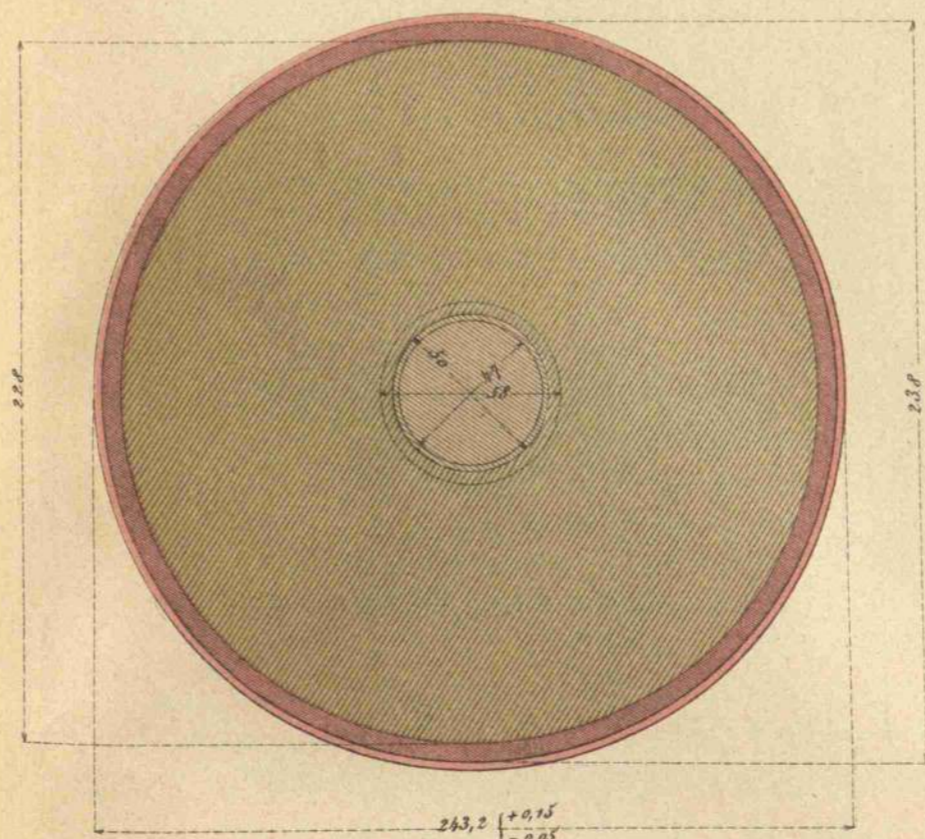

Perforante (2/5)  
(de hierro endurecido)

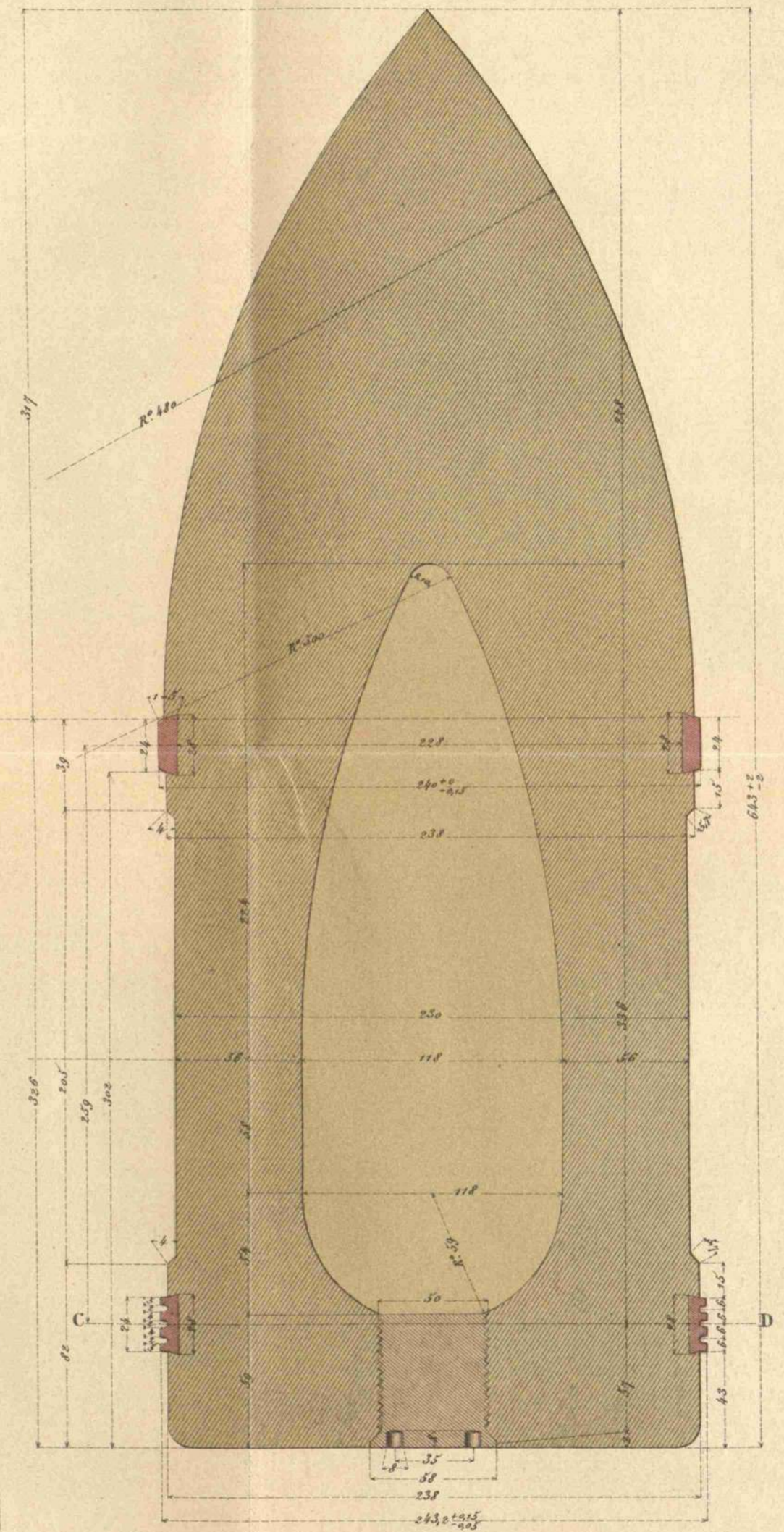

Peso de la granada vacía ..... Kg. 141,600 ± 1,42  
 Id. .... id. cargada ..... „ 144



# LLAVE DE ESPOLETAS MODELO 1886.

Ll. Esp. Md. 1886.  
Escala 1/4.

Espoletas á que se aplican las diferentes partes de esta llave.

- a } Percusion Md. 1865.
- o o }
- a } Percusion Md. 1865 Rf. al 80.
- o o }
- o o } Percusion Md. 1882.
- a a' } Tiempos Md. 1880.
- n n n }
- p q r } Krupp.
- n n n }

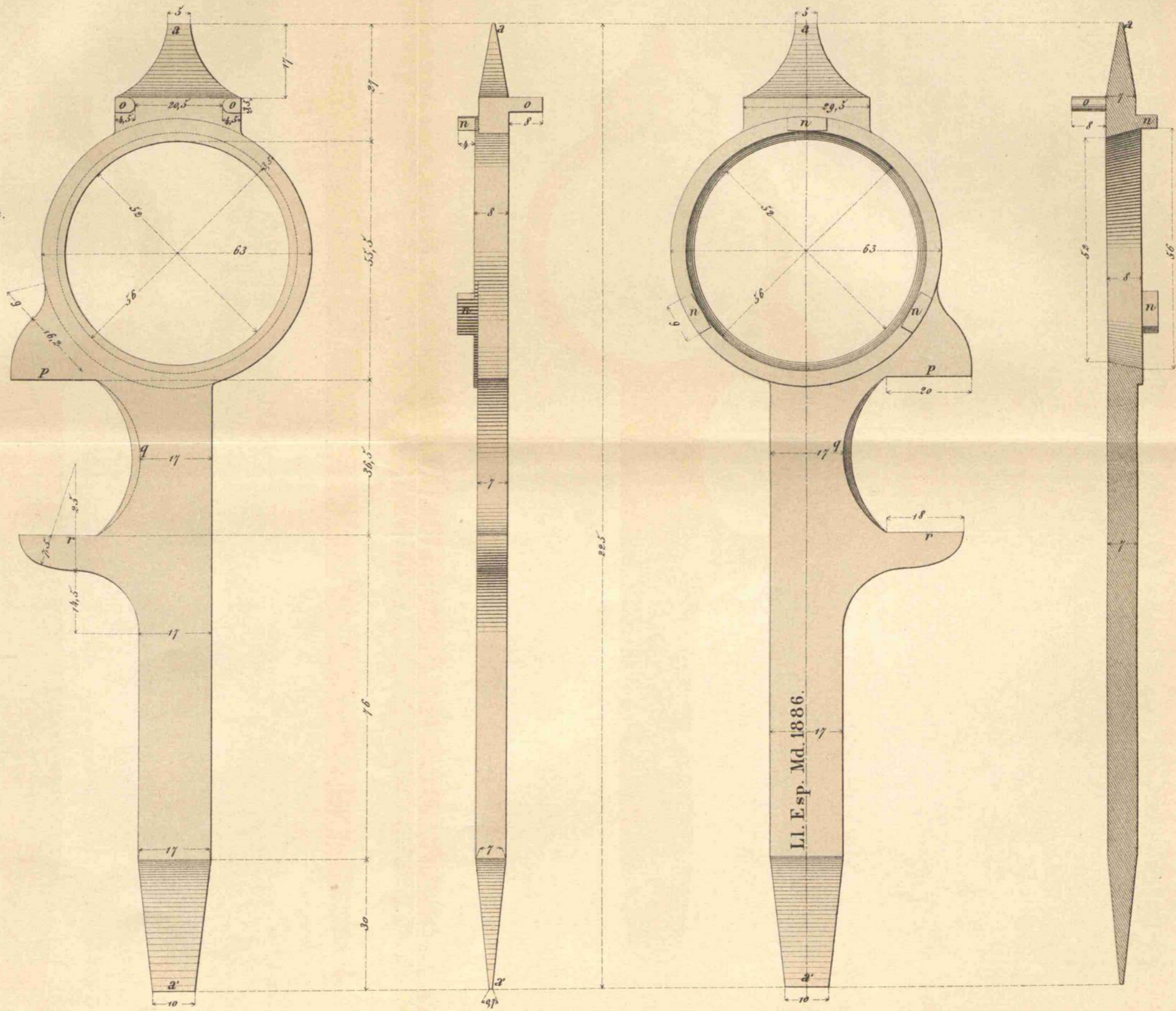



CARTUCHO DE 27 Kg. DE PÓLVORA PRISMÁTICA DE 1 CANAL PARA C.H. 24. Cc. Md. 1881.

Escala 1/5.

Culote.

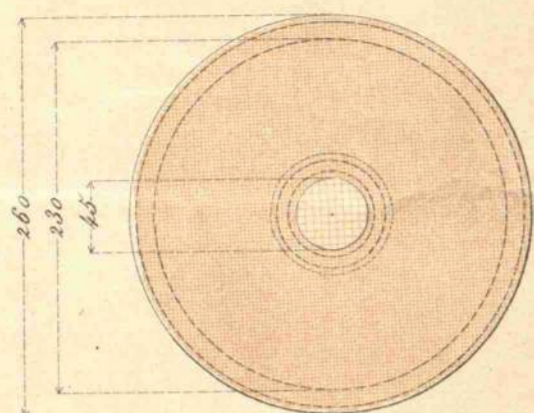

Cañamazo.



Corte por AB.

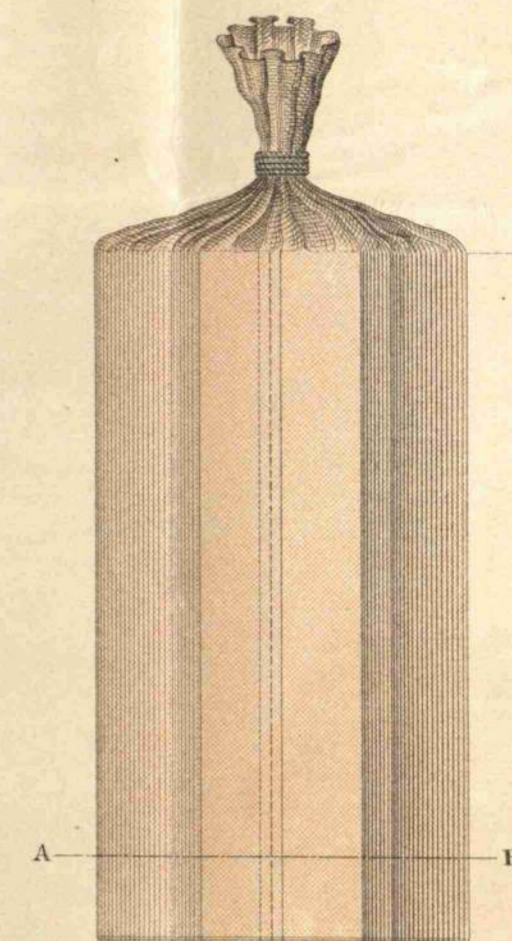
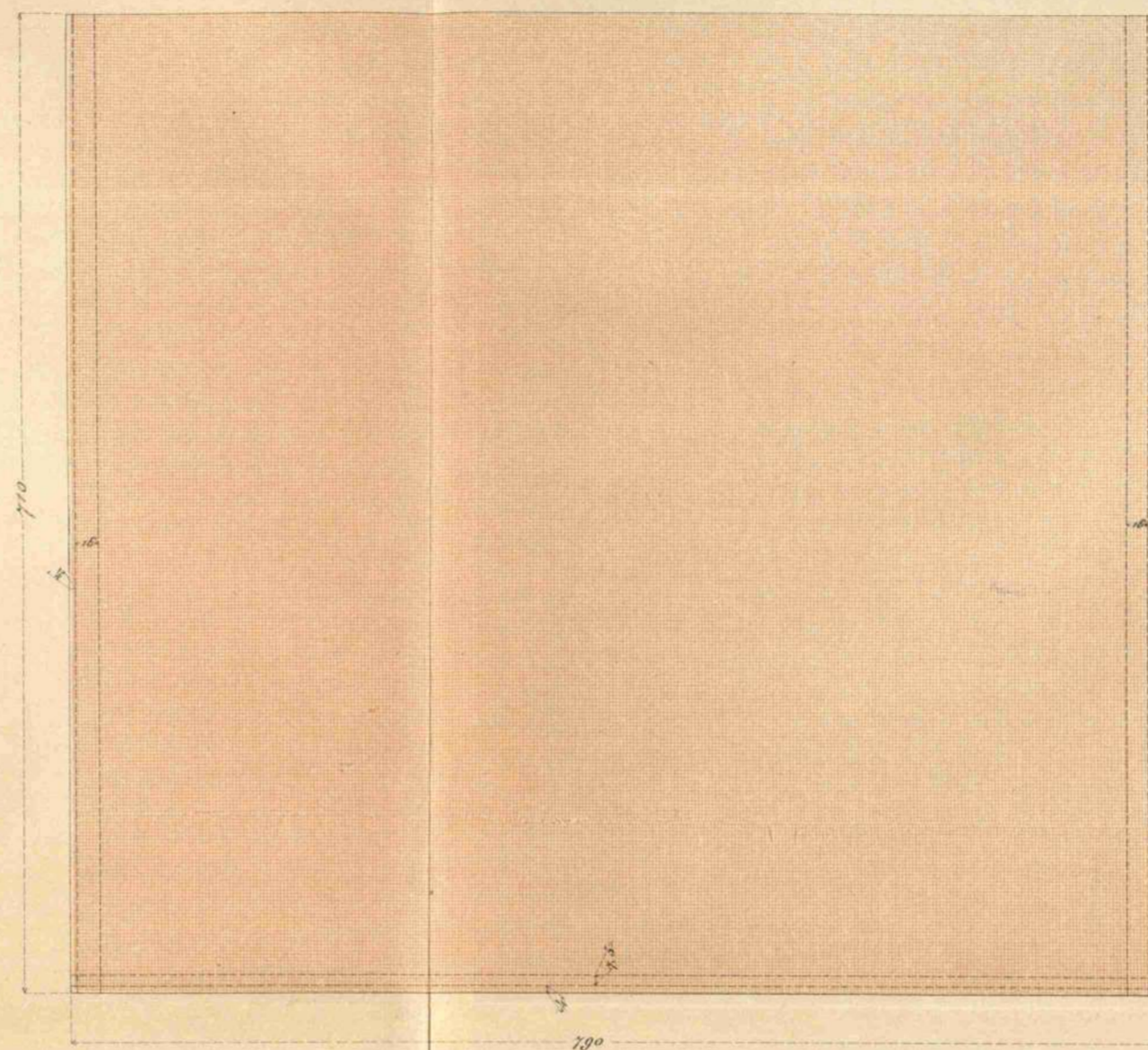
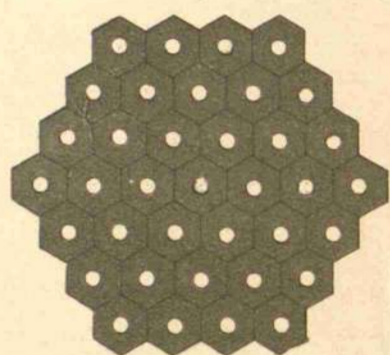

A B

242,5

CARTUCHO DE 20 Kg. DE PÓLVORA PRISMÁTICA DE 7 CANALES PARA C.H. 24. CON PROYECTIL DE TETONES.

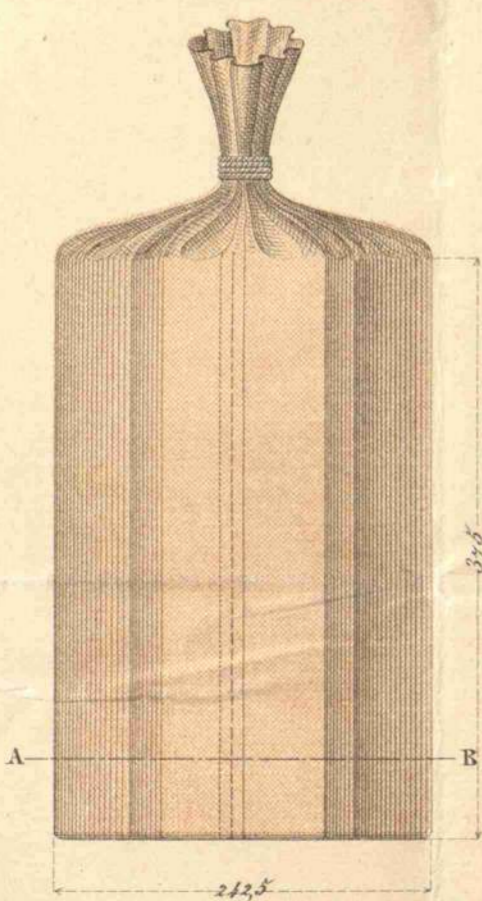

A B

242,5

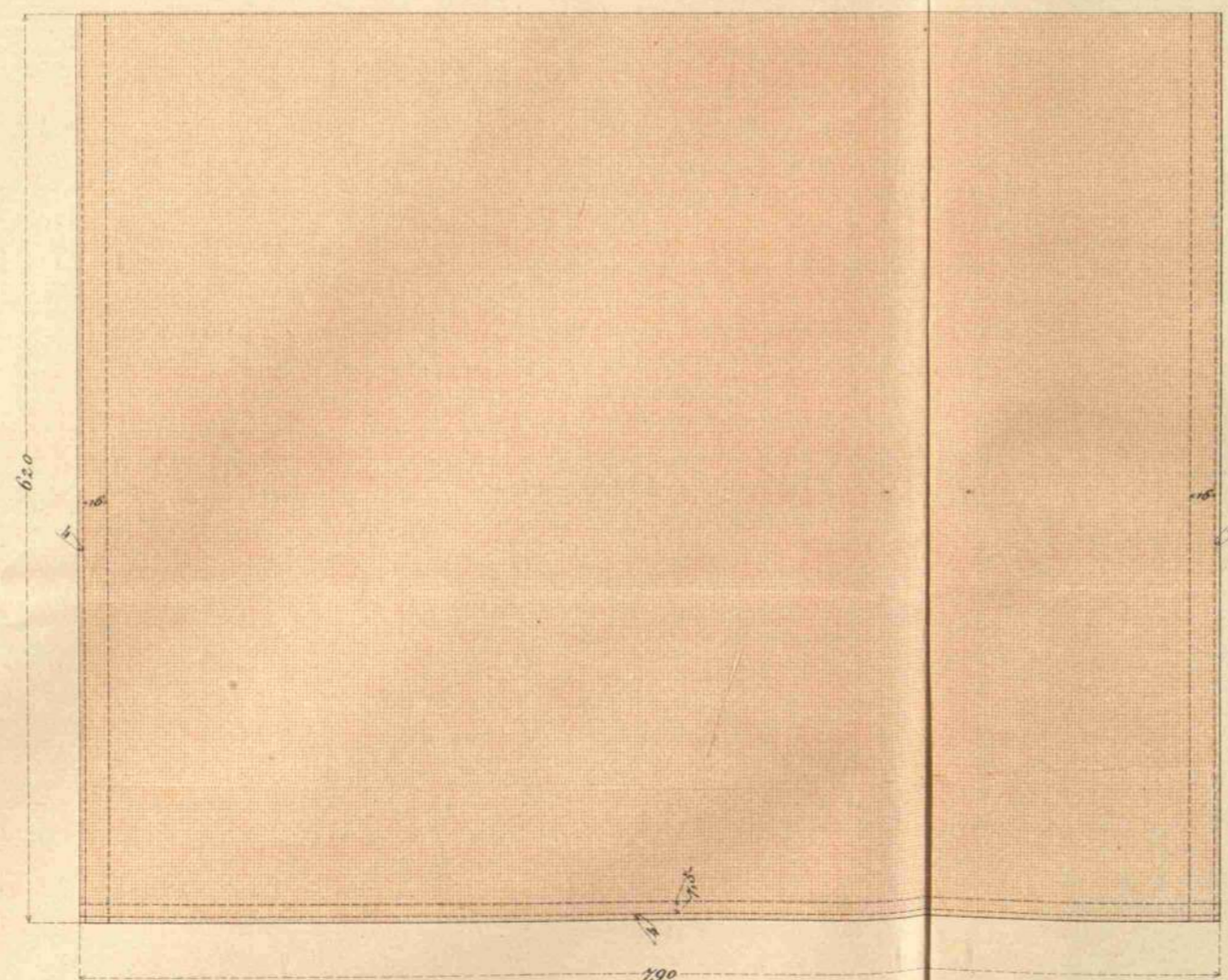

Culote.

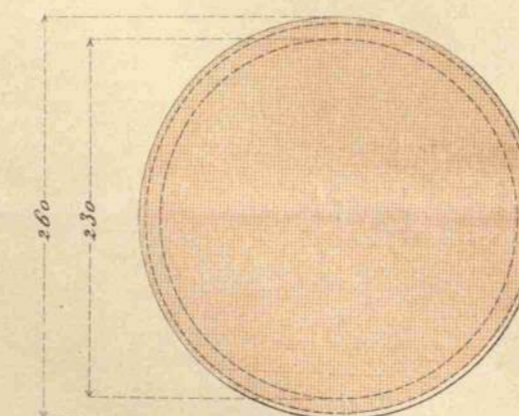

Corte por AB.

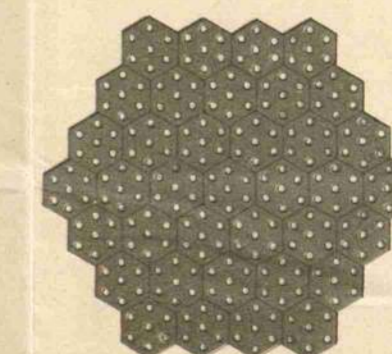



# GRANADAS DE METRALLA DE 8 Y 9 MODELO 1887.

Escala 1/4

G. Mlla. De 8 cm. Md. 1887.

G. Mlla. De 9 cm. Md. 1887.

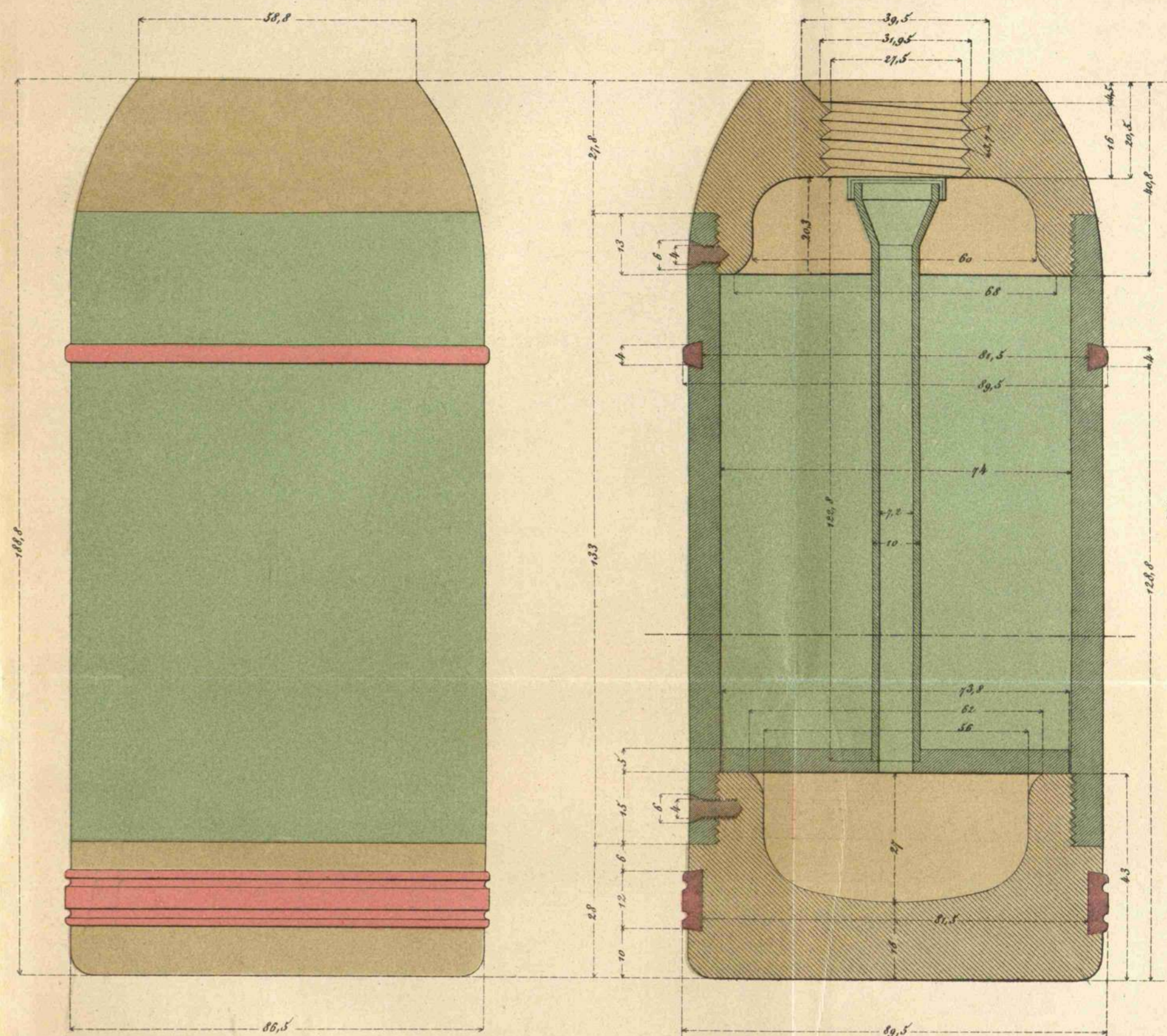
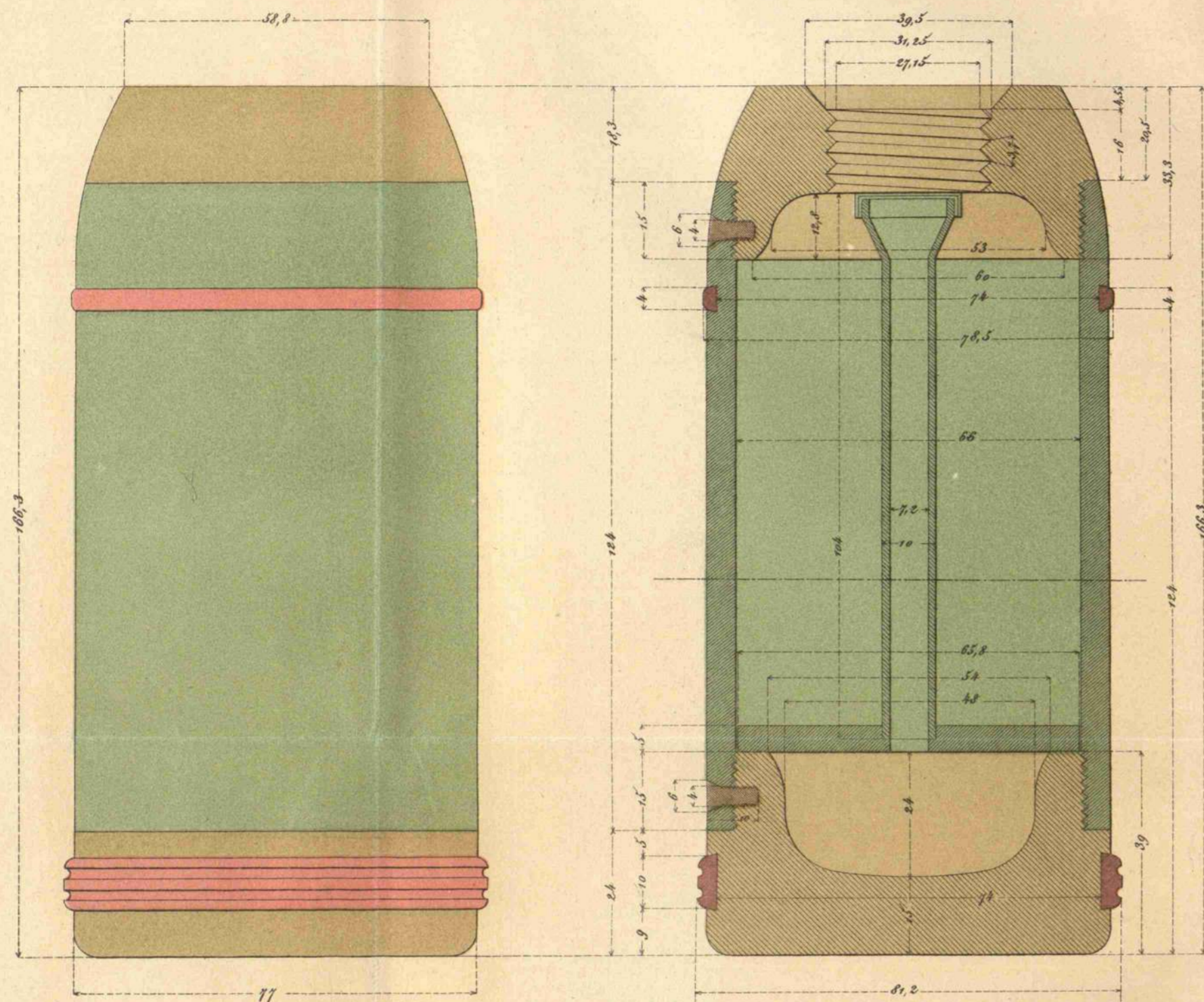

Pesos		Kg. <sup>s</sup>
Granada vacia	.....	2,488
Balines	.....	1,820
Tubo, diafragma y colofenia	.....	0,339
Carga explosiva	.....	0,060
Espoleta	.....	0,450
Total	.....	5,157
Número de balines	.....	140
Peso de cada uno	.....	13

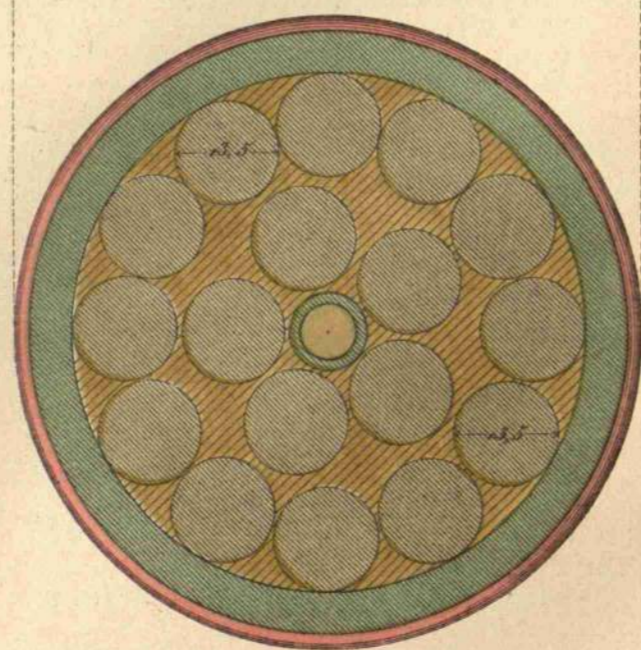

Pesos.		Kg. <sup>s</sup>
Granada vacia	.....	3,445
Balines	.....	2,730
Tubo, diafragma y colofenia	.....	0,479
Carga explosiva	.....	0,068
Espoleta	.....	0,450
Total	.....	7,172
Número de balines	.....	210
Peso de cada uno	.....	13

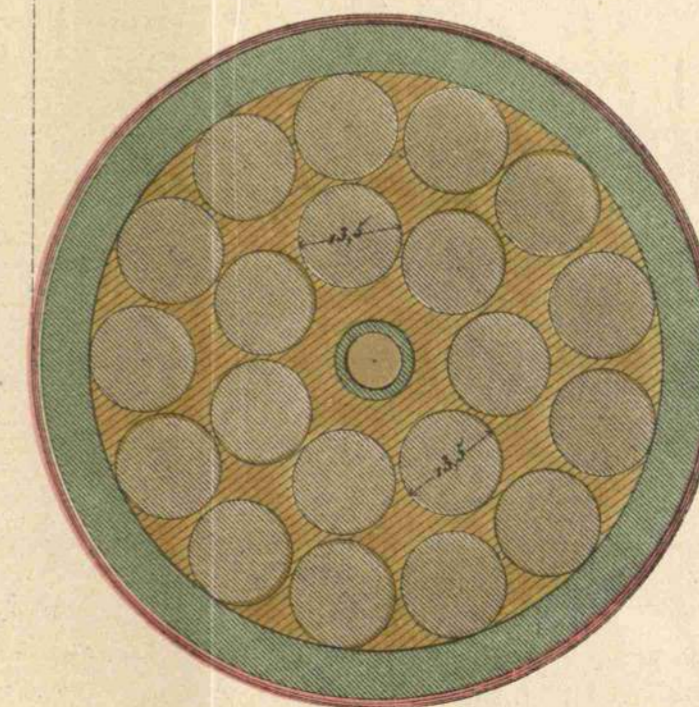



MATERIAL DE PLAZA COSTA Y SITIO.

CUREÑA DE CHAPA MD. 1881 PARA C.B. I.A. Co.

Escala 1/10.

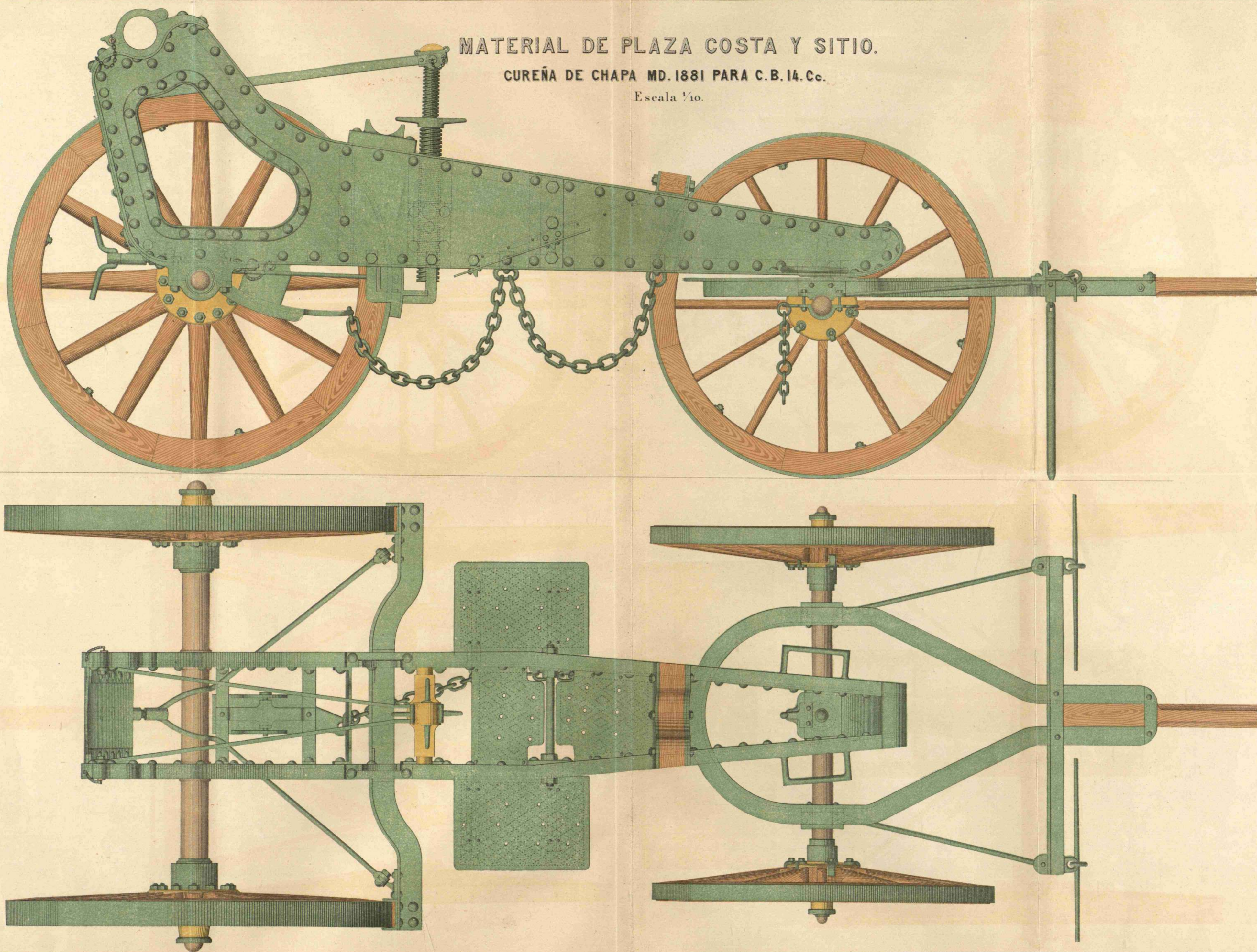







# MATERIAL DE PLAZA COSTA Y SITIO.

## CUREÑA DE CHAPA MD. 1881 PARA C.B. 14 Co.

### DETALLES.

Gualdera (2) (1/10)

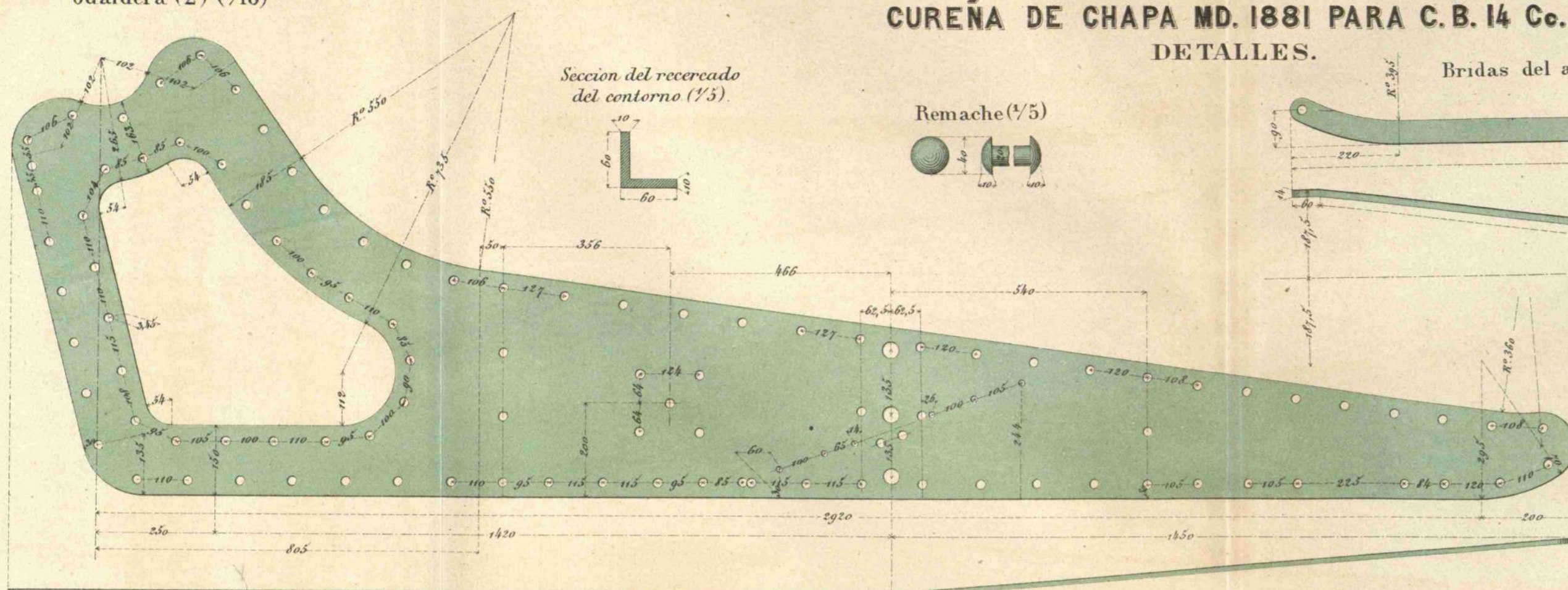

Remache (1/5)



Bridas del aparato de punteria (1/10)

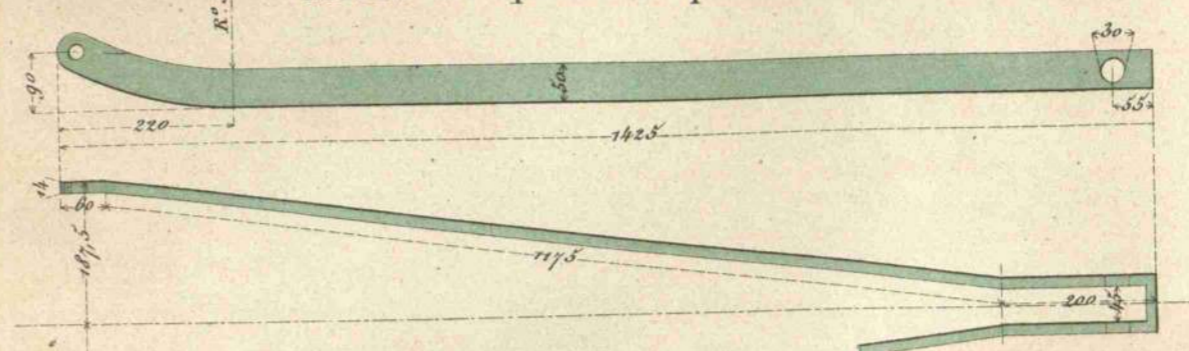

Cabeza del tornillo de punteria (1/5)

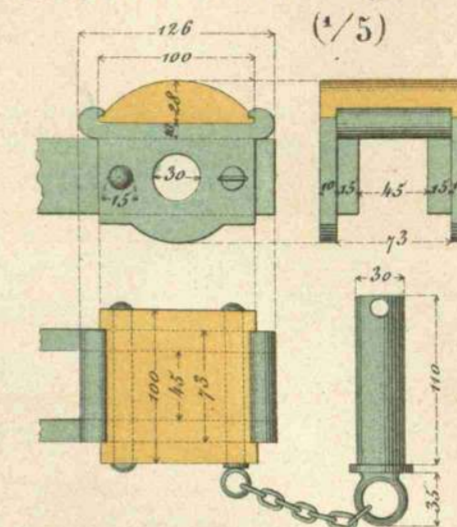

Tornillo de punteria (1/5)

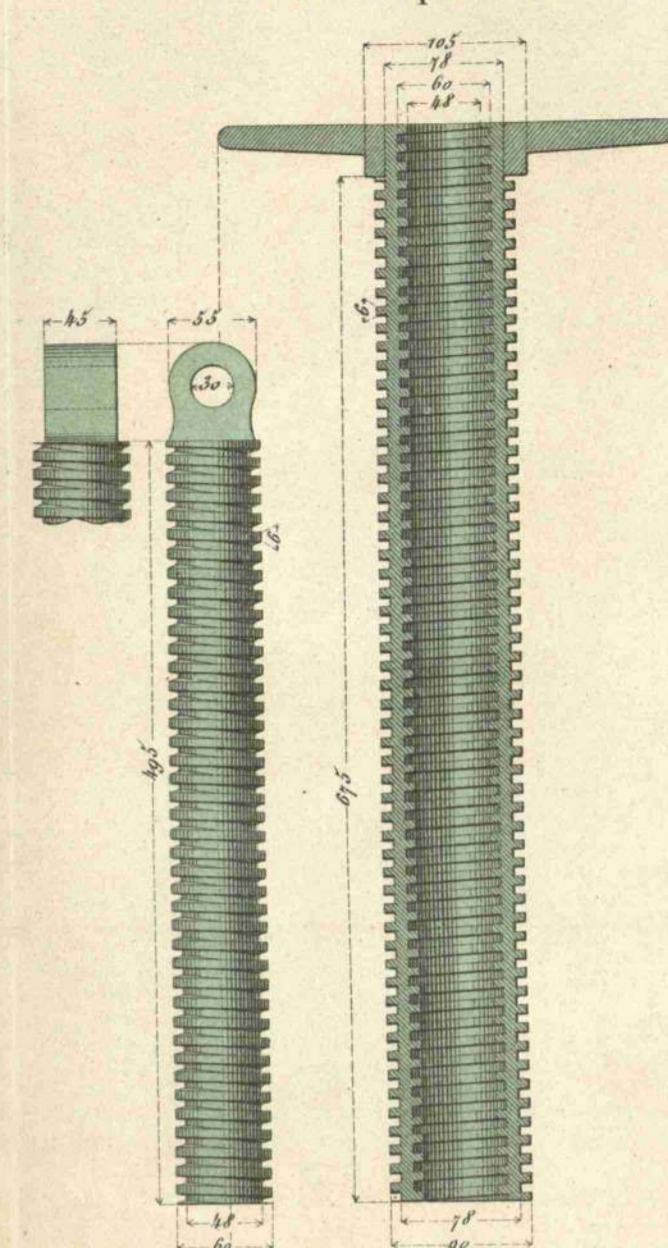

Recercado del vano (1/10)

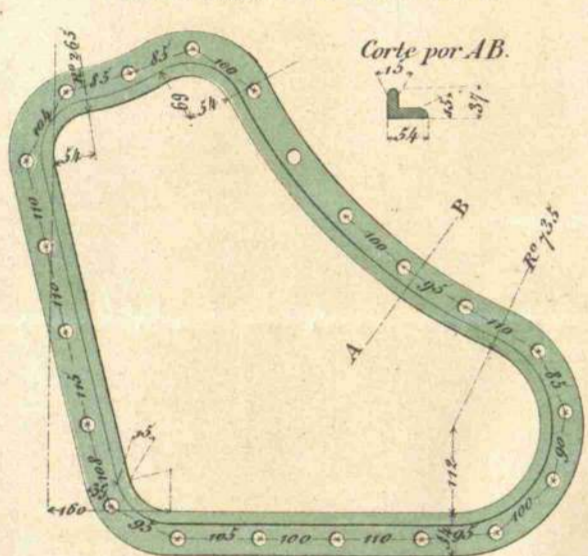

Chapa de testera (1/10)

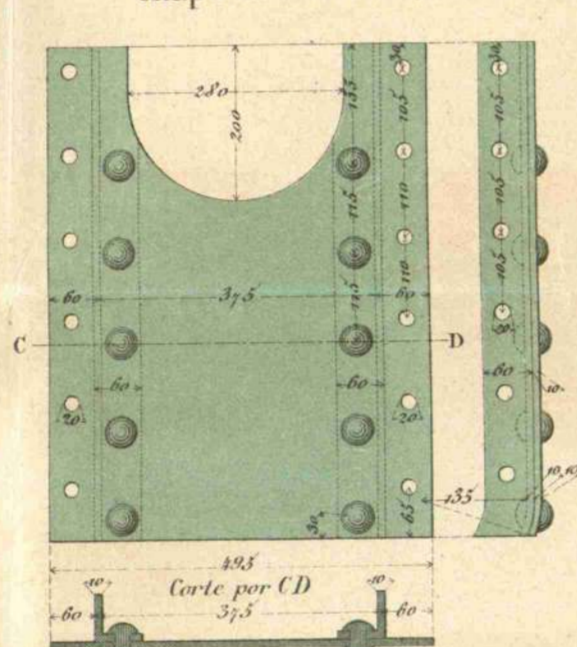

Telera (1/10)

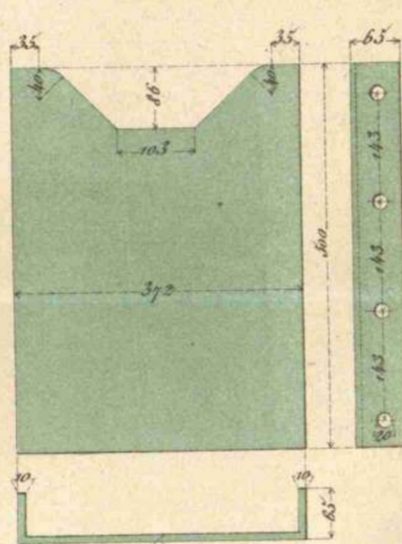

Soporte de la tuercia del tornillo (2) (1/10)

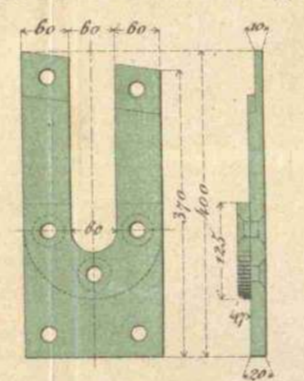

Tuerca del tornillo de punteria (1/5)

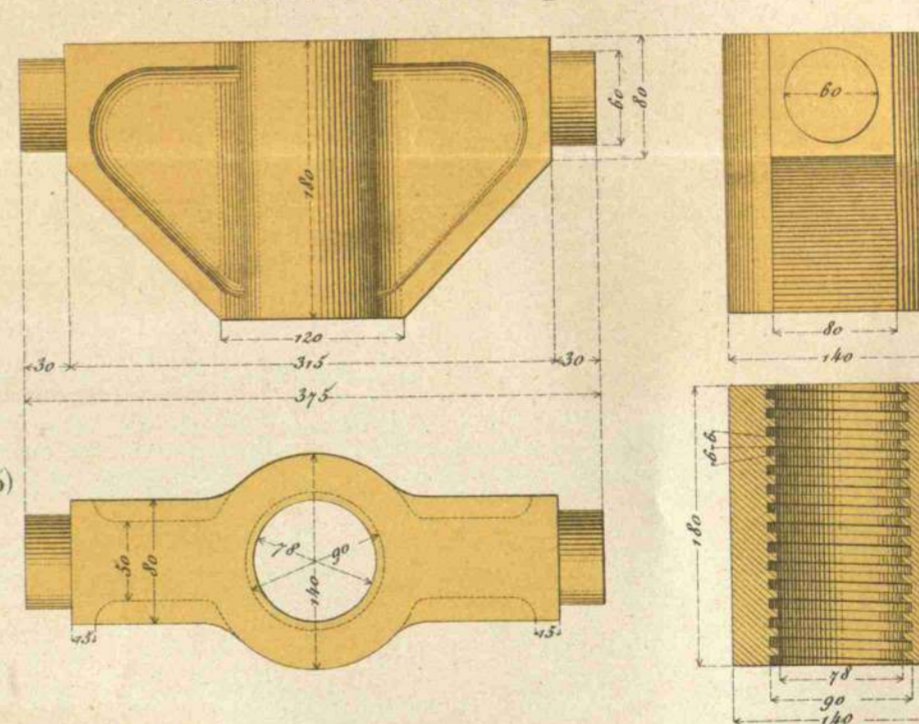

Sobremuñonera (2) (1/5)

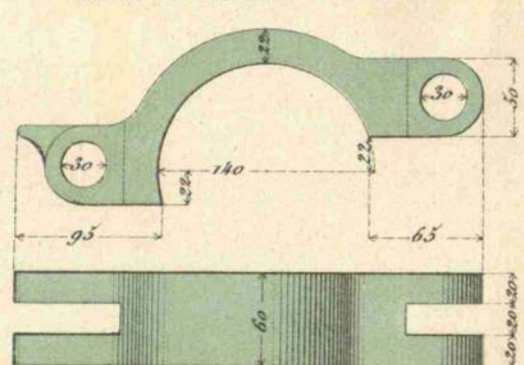

Muñonera de camino (2) (1/5)

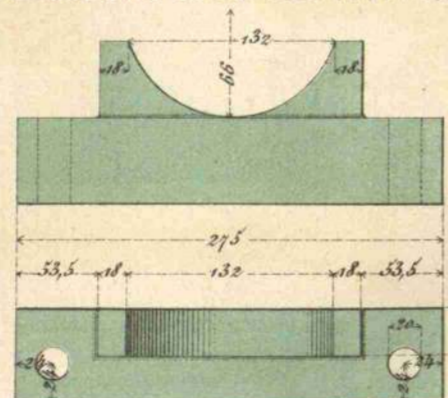

Sotabraga (2) (1/5)

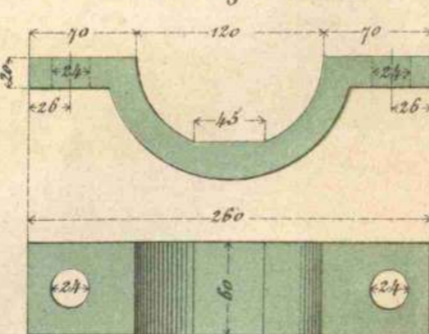

Chapas que refuerzan las gualderas (interiores) (2) (1/5)

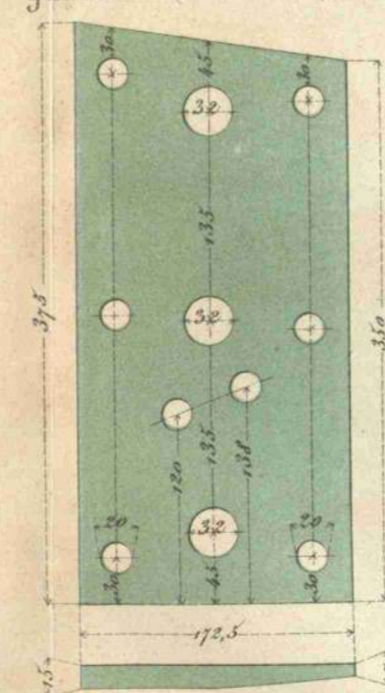

Chapas que refuerzan las gualderas (exteriores) (2) (1/5)

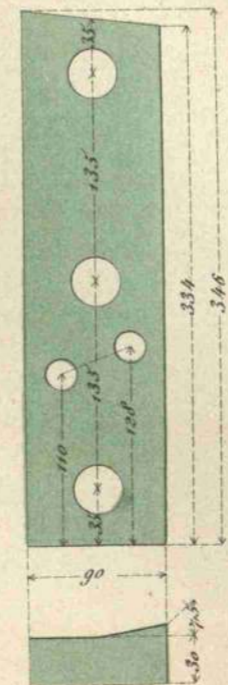

Pernos pasadores (3) (1/5)

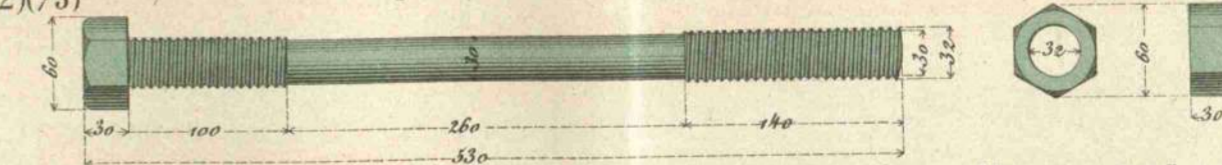

Muñonera (2) (1/5)

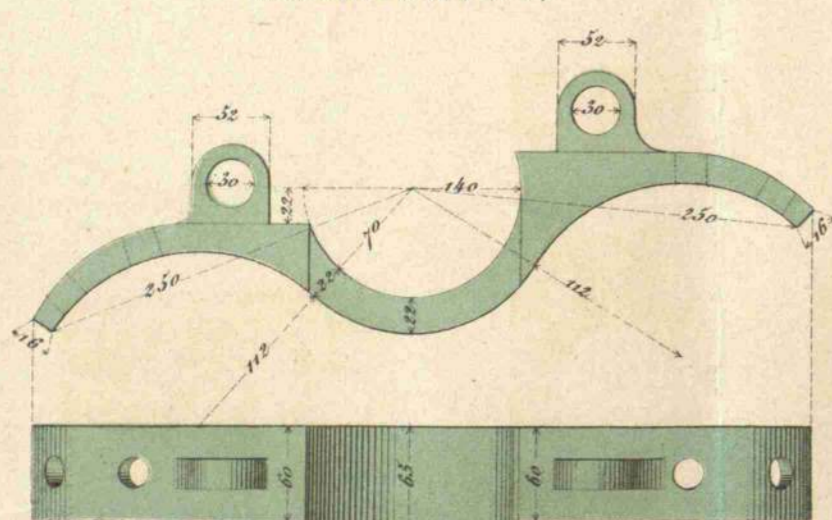

Muñonera de camino (2) (1/5)

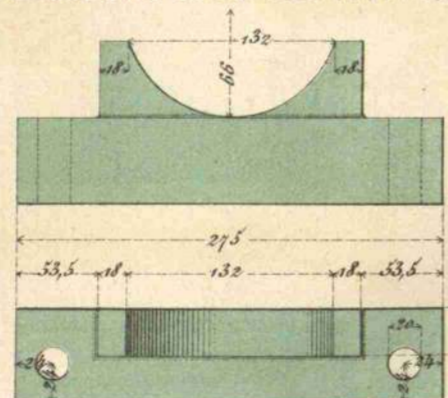

Pernos de la sotabraga (2) (1/5)

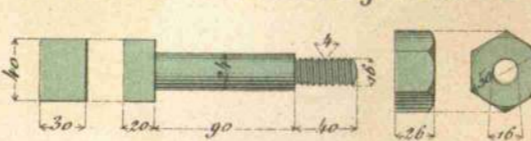

Braga (2) (1/5)

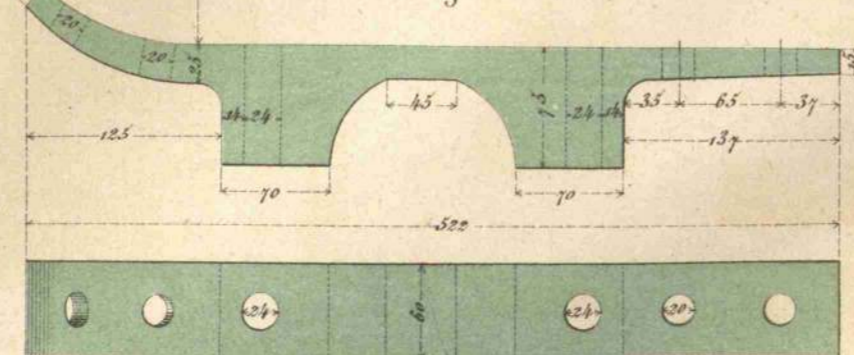

Refuerzo del cabezal (1/10)

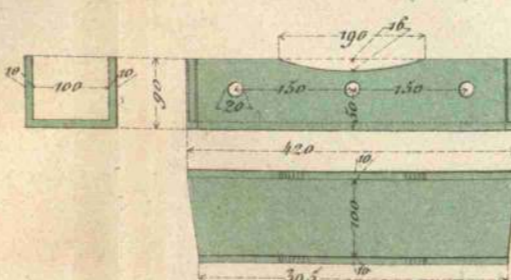

Refuerzo del taladro del pinzote (1/5)

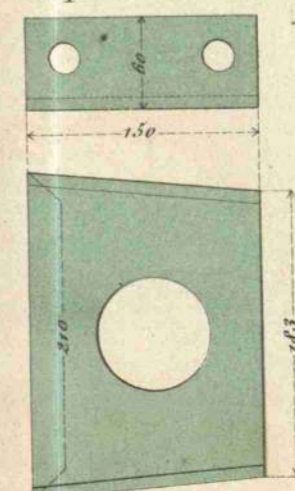

Chapa rozadero de contera (1/10)

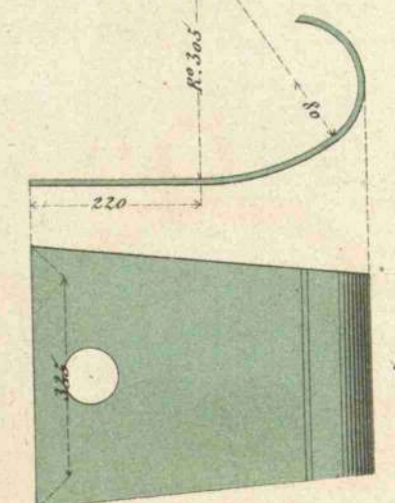







# MATERIAL DE PLAZA COSTA Y SITIO.

## CRIC HIDRAULICO DE 10 TONELADAS MODELO 1883.

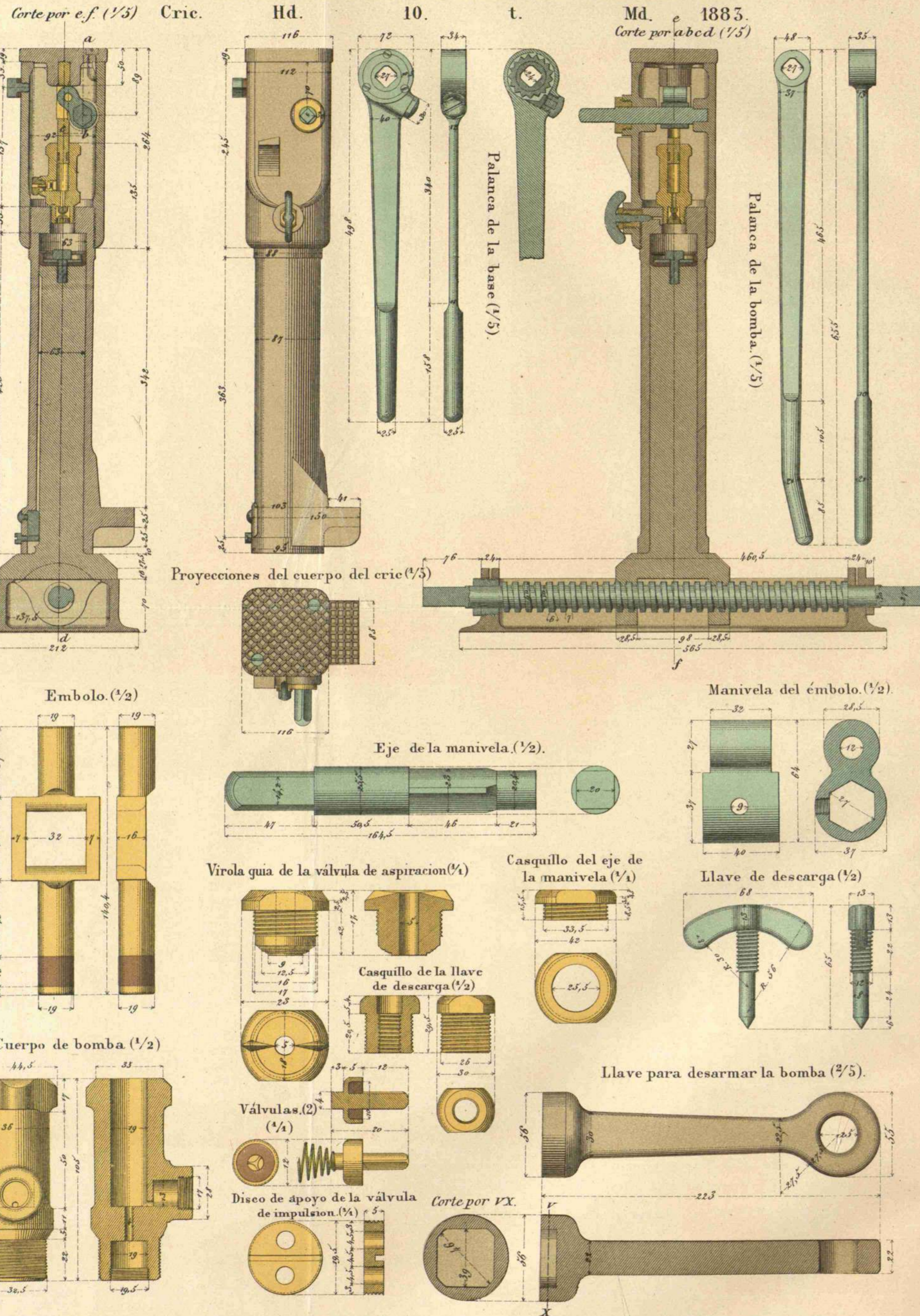

## CRIC HIDRAULICO DE 30 TONELADAS MODELO 1882.

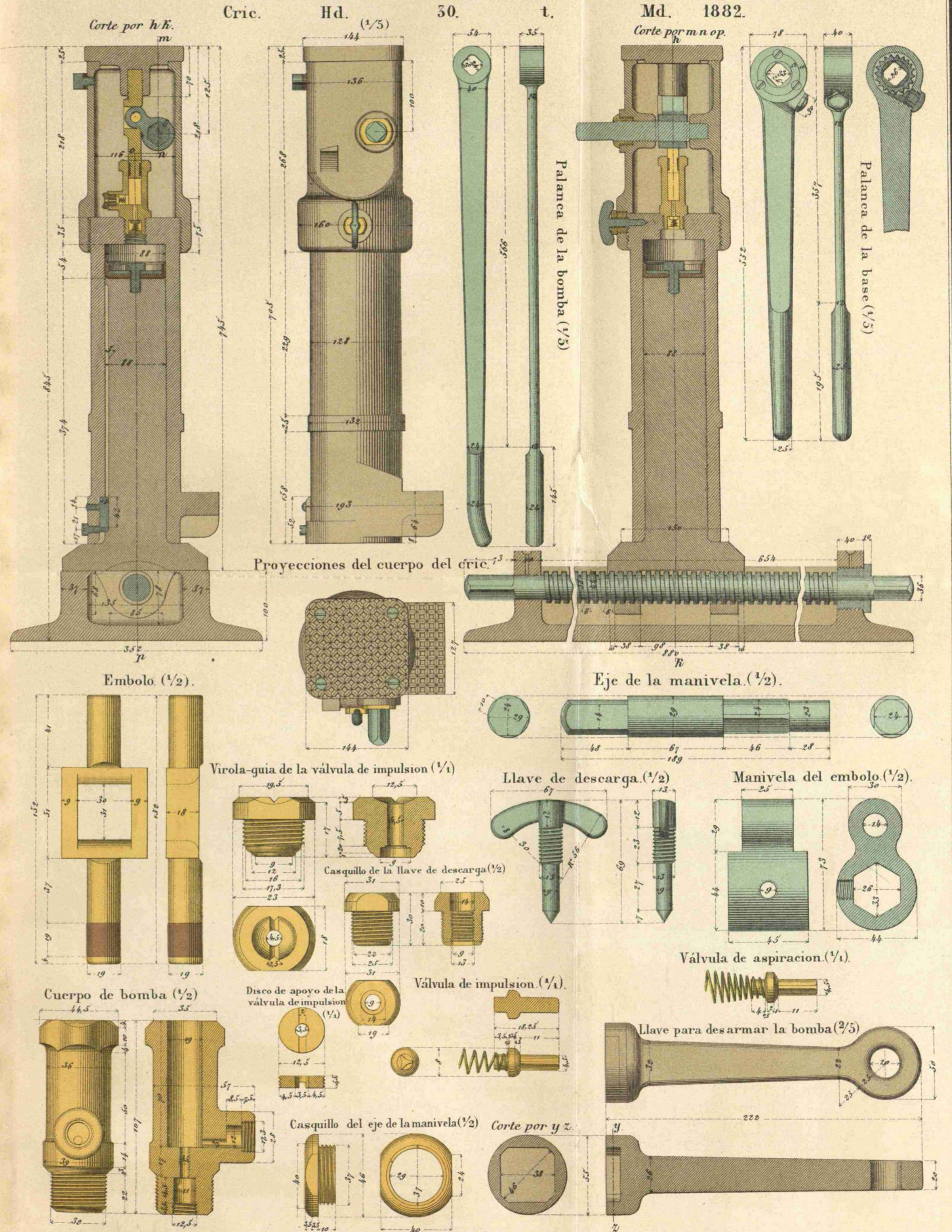



# MATERIAL DE PLAZA COSTA Y SITIO.

## CUREÑA DE CHAPA MODELO 1875

Cña. Ch. Md. 1875.

### PARA CAÑÓN DE ACERO DE 15 CARGADO POR LA CULATA.

C. Ac. 15 Cc.

Escala 1/10.

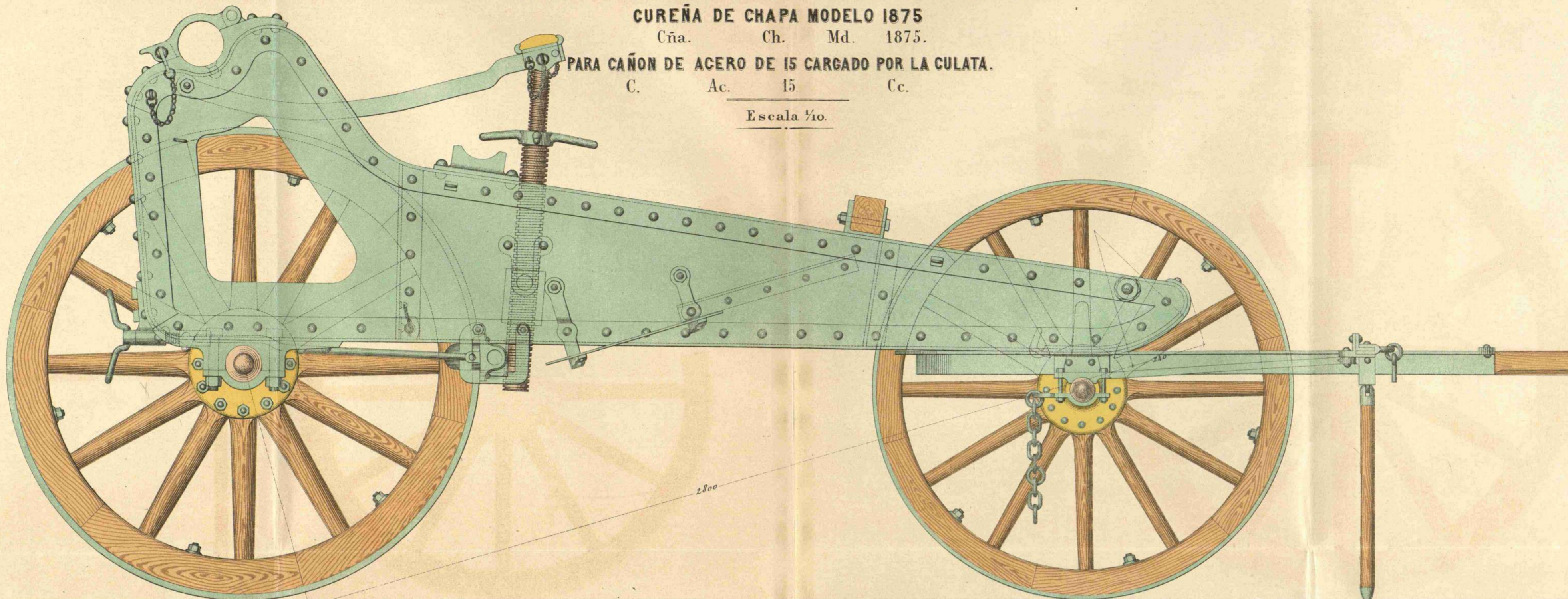

Peso de la cureña...1500 Kg.

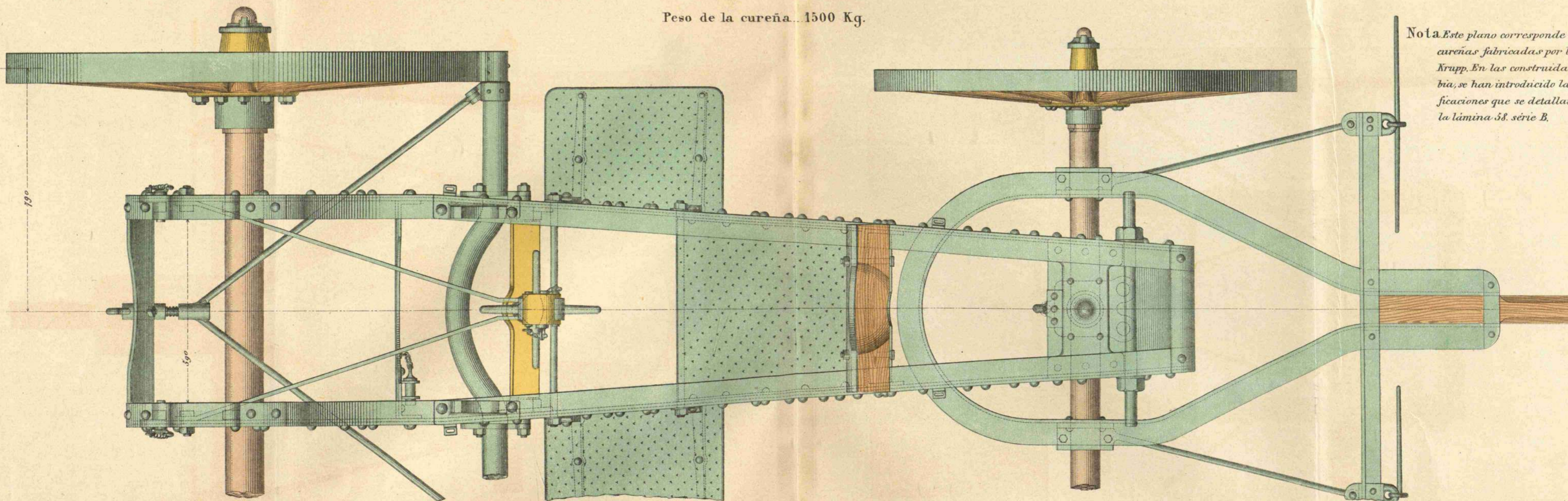

*Nota. Este plano corresponde a las cureñas fabricadas por la casa Krupp. En las construidas en Trubia, se han introducido las modificaciones que se detallan en la lámina 58. serie B.*







# MATERIAL DE PLAZA COSTA Y SITIO.

## CUREÑA DE CHAPA MODELO 1875 PARA CAÑÓN DE ACERO DE 15 CARGADO POR LA CULATA.

Cña. Ch. Md. 1875. C. Ac. 15. Ce.

### DETALLES.

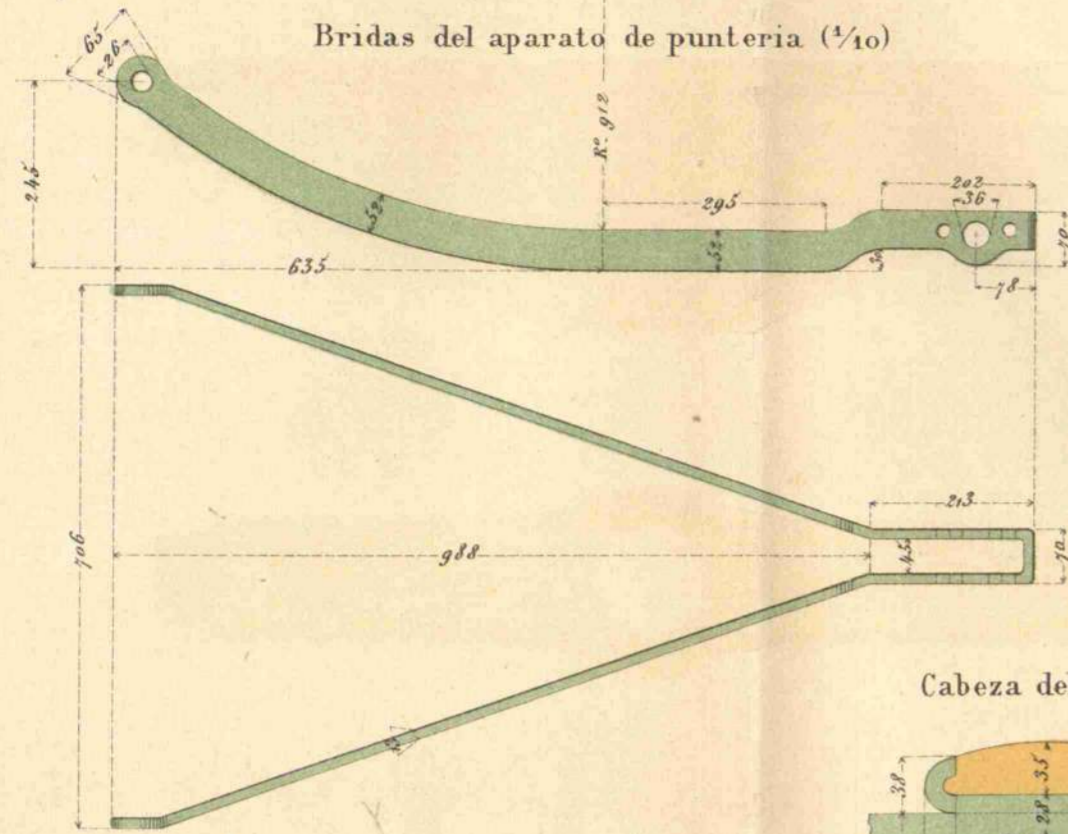

Manivela del tornillo de punteria (1/5)

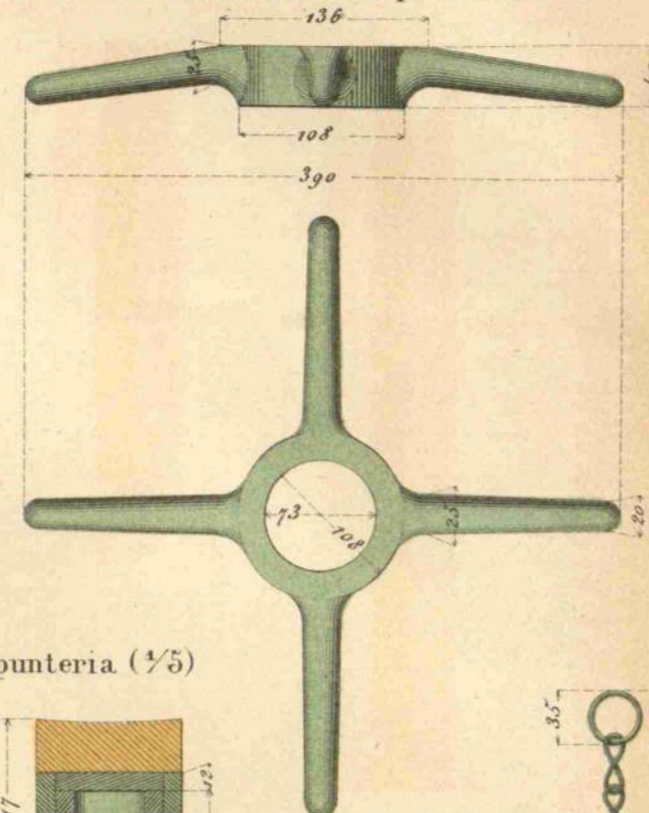

Tornillo de punteria (1/5)

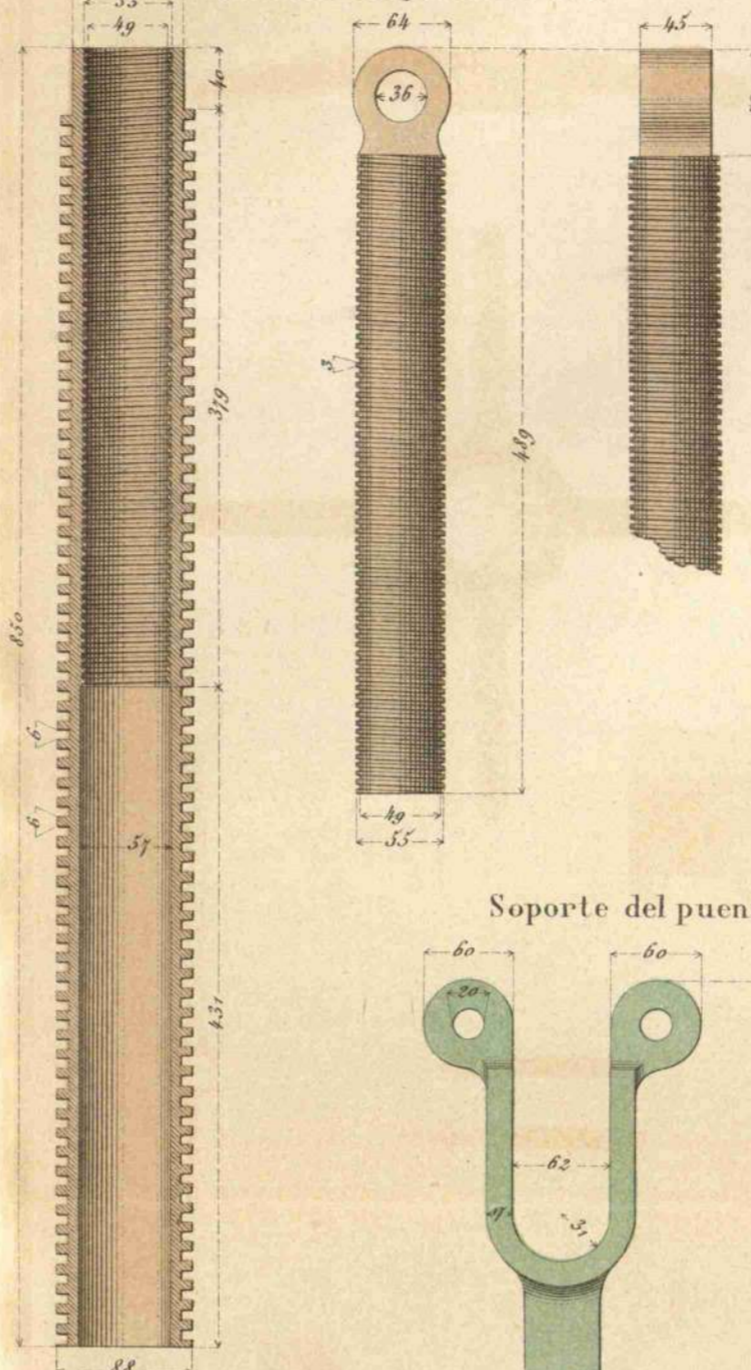

Puente del tornillo de punteria (1/5)

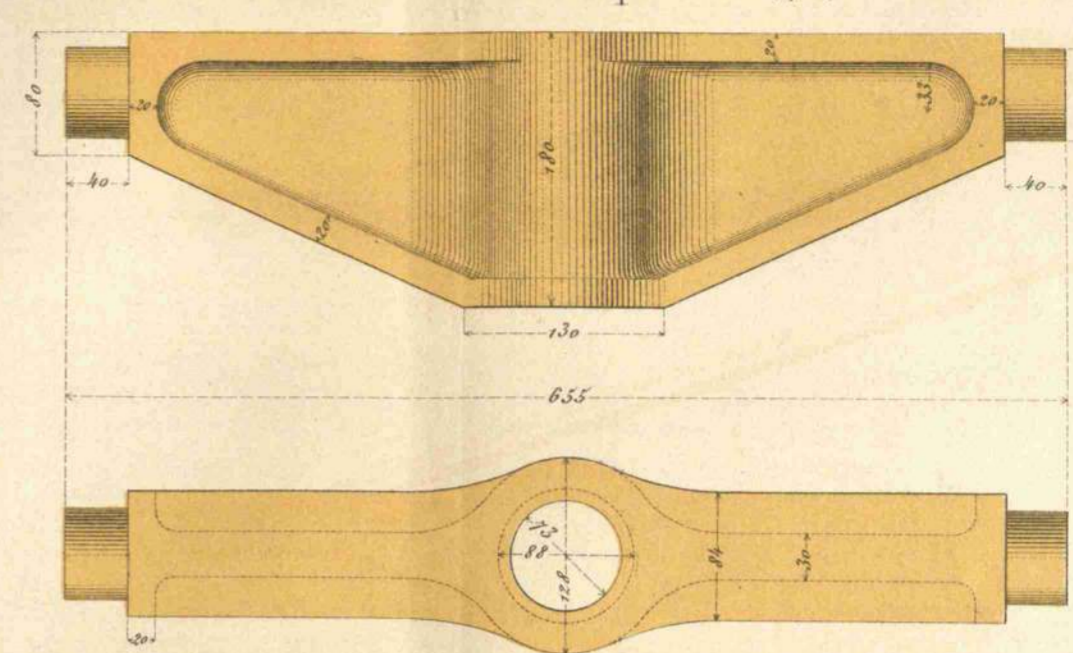

Cabeza del tornillo de punteria (1/5)

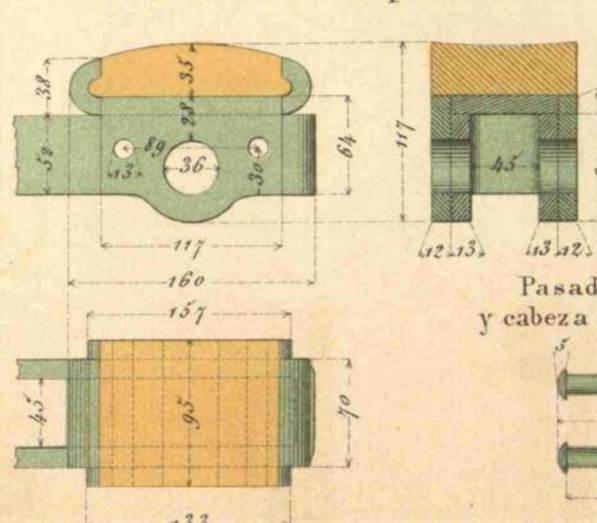

Perno de la cabeza del tornillo (1/5)

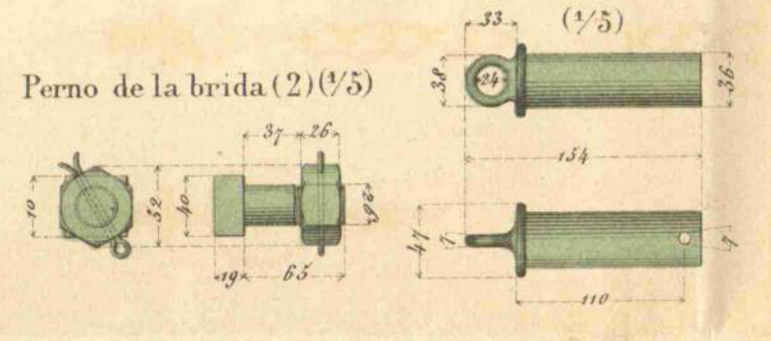

Pasador de la brida y cabeza del tornillo (2) (1/5)

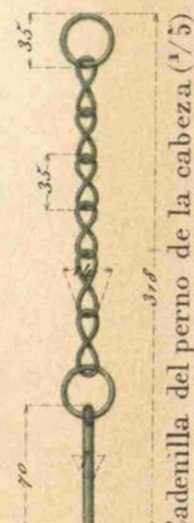
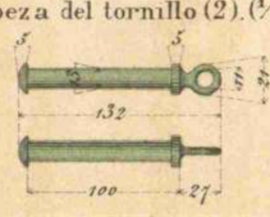

Soporte del puente (2) (1/5)

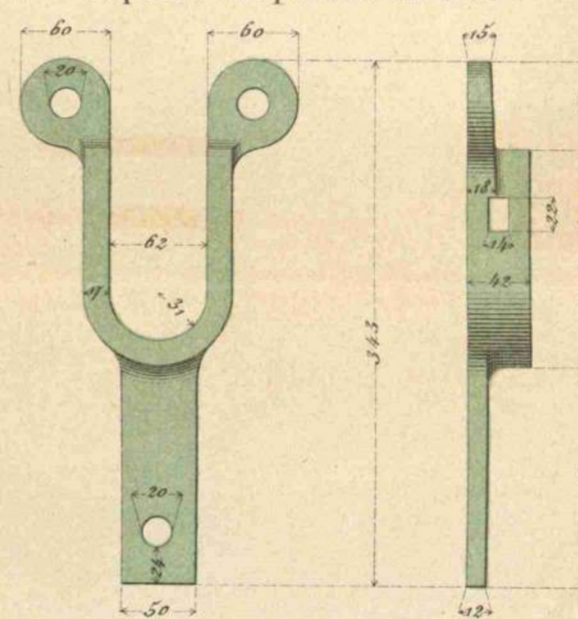

Cadenilla de la chaveta (2/5)

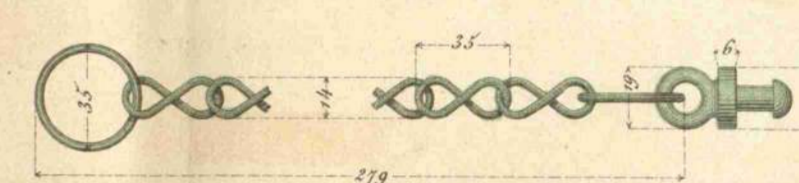

Chaveta del soporte de puente (1/5)

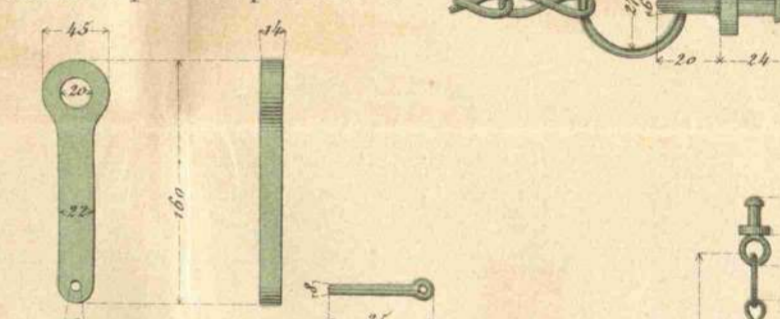

Tirantes del freno (1/10)

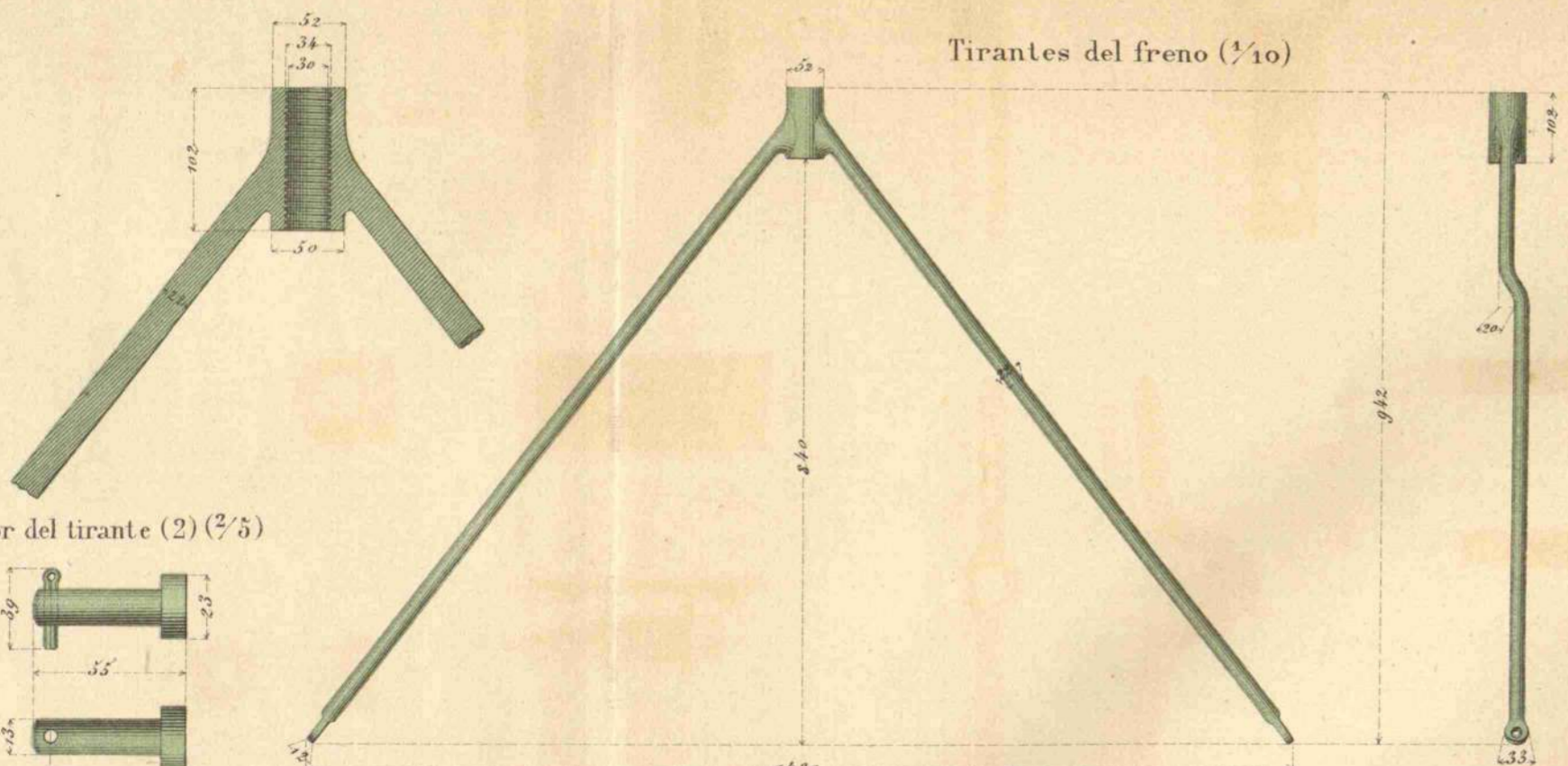

Tornillo del freno (1/5)

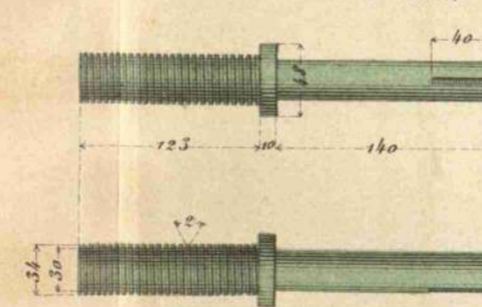

Manivela del freno (1/5)

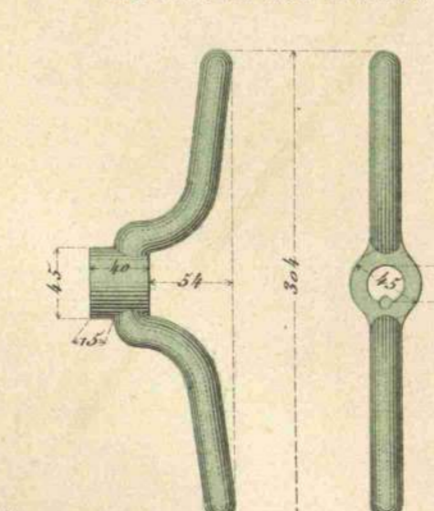

Sosten de la cabeza del tornillo de punteria en posicion de marcha (1/5)

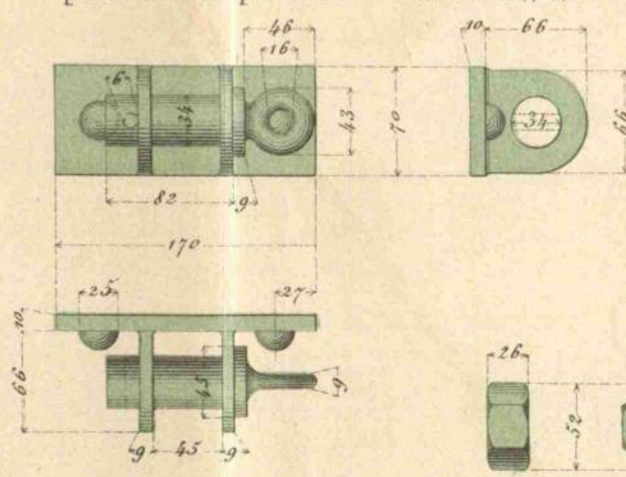

Cadenilla del perno de sujecion de la cabeza (1/5)



Pasador del tirante (2) (2/5)

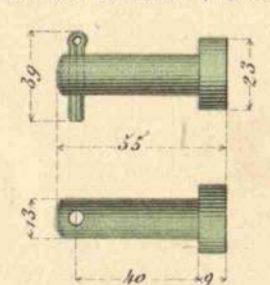

Freno (1/10)

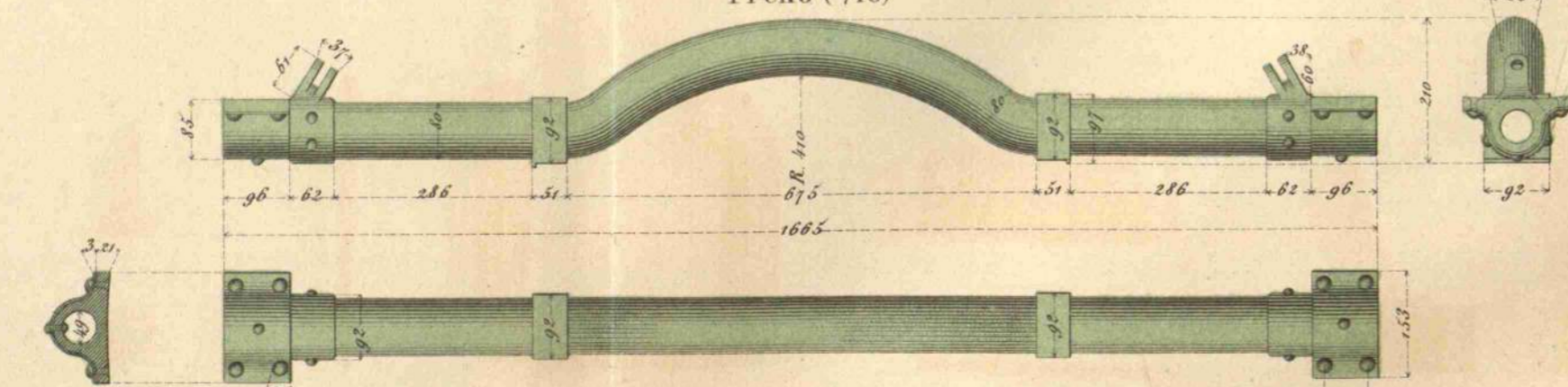

Soporte del tornillo del freno (1/5)

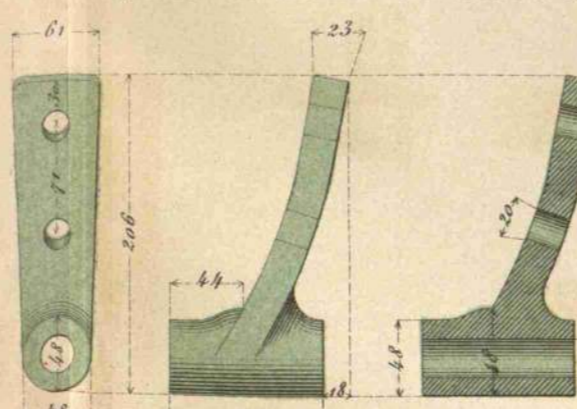

Suplemento de la guia (2) (1/5)

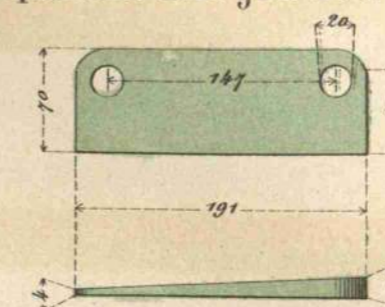

Guia del freno (2) (1/5)

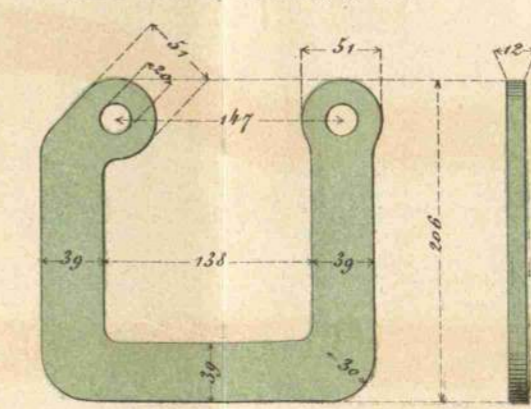

Perno de la guia (4) (1/5)

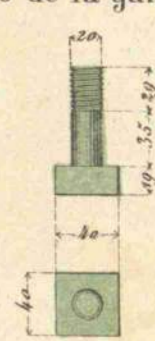



# MATERIAL DE PLAZA COSTA Y SITIO. CUREÑA DE CHAPA Y AVANTREN MODELO 1875 PARA CAÑÓN DE ACERO DE 15 CARCADO POR LA CULATA.

Cña Ch. Av. Md. 1875. C. Ac. 15. Cc.

## DETALLES.

Rueda del avantren (1/10)

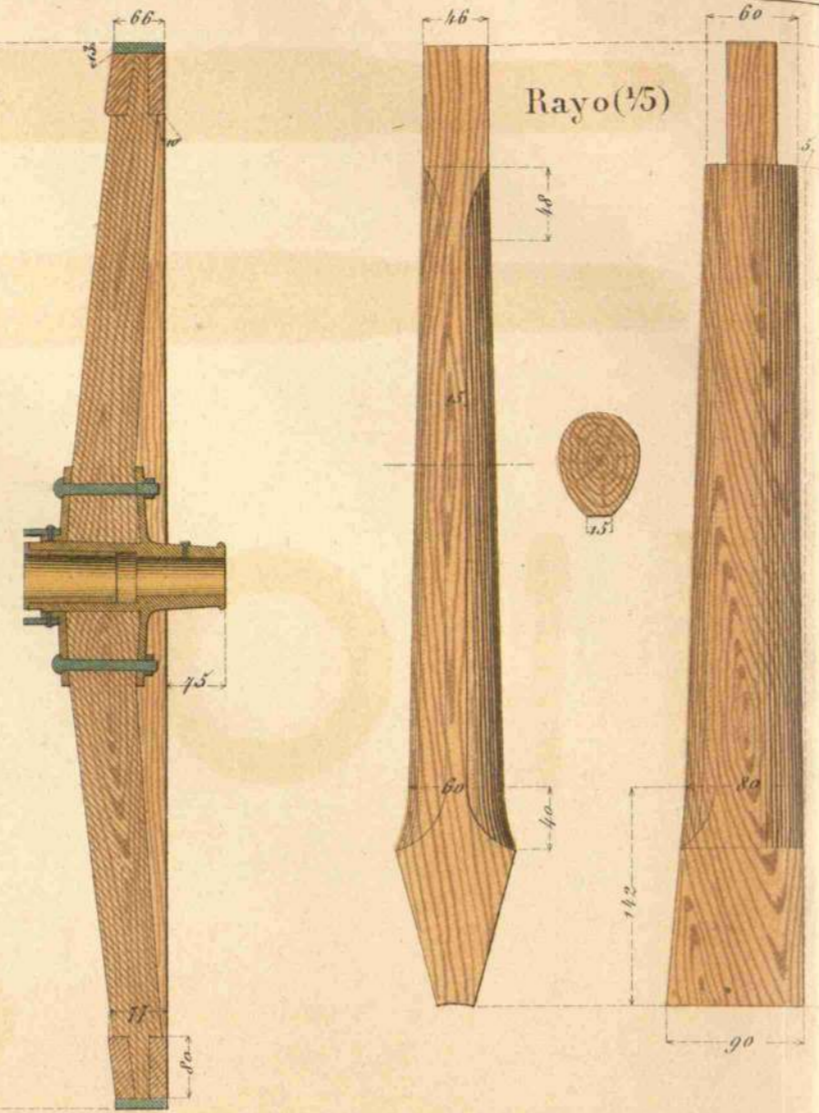
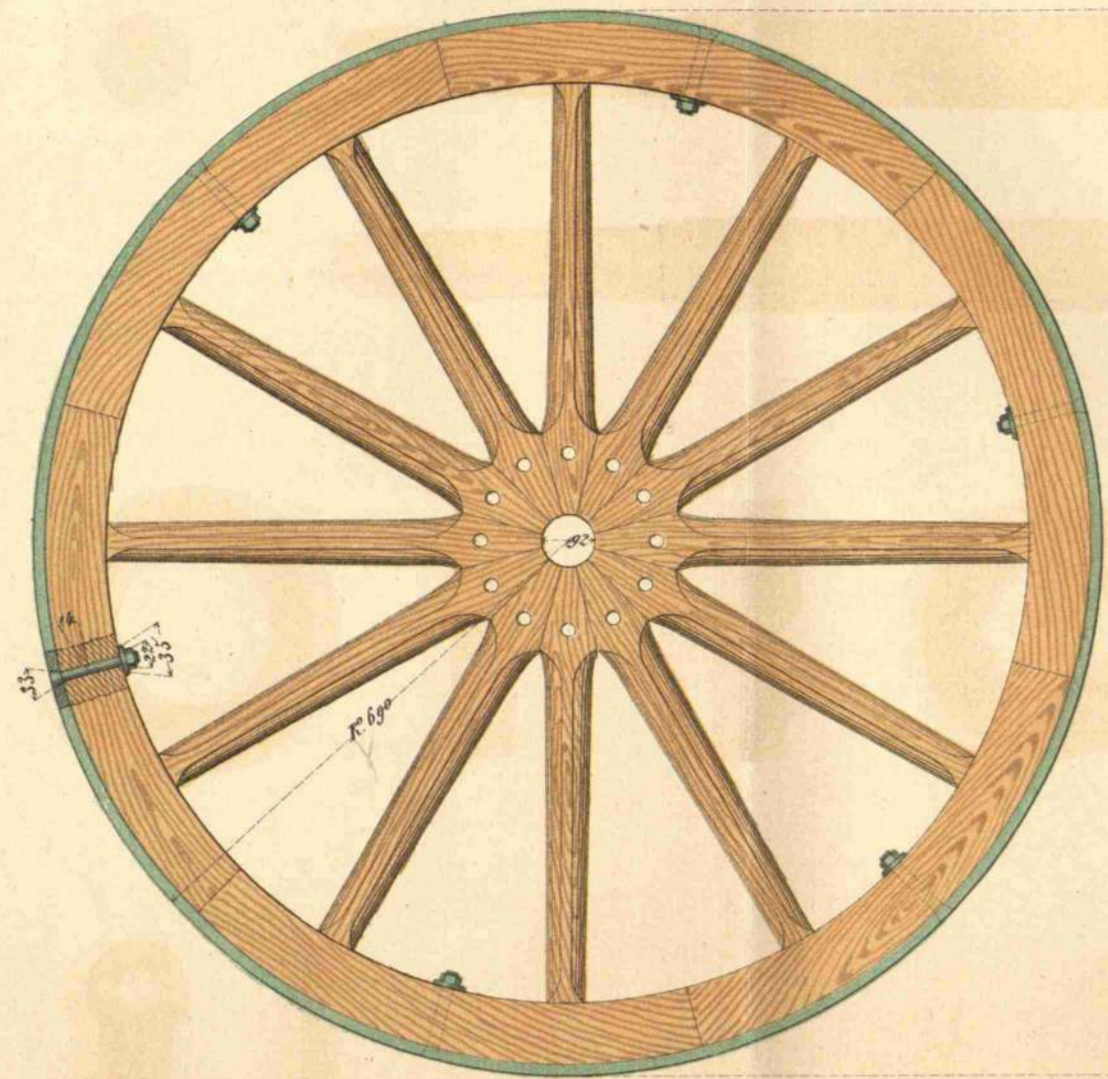

Eje de la cureña (1/10)

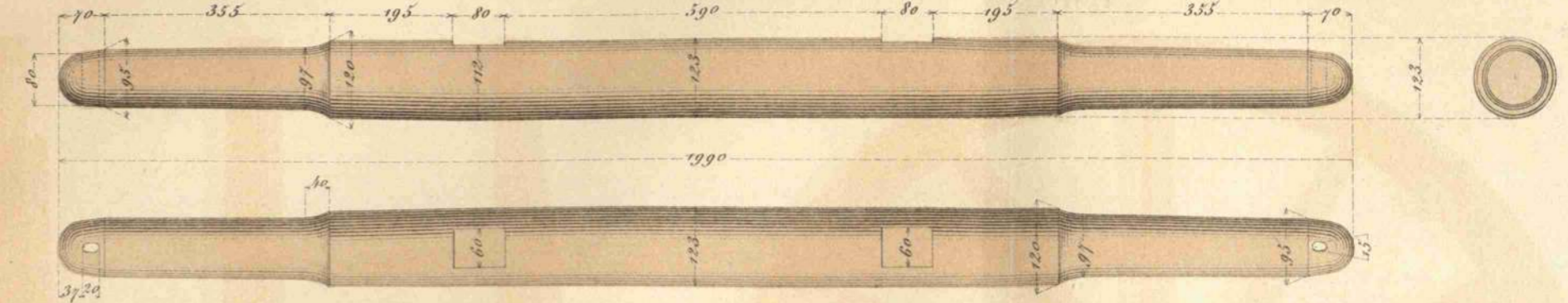

Sotrozo (Cureña) (2/5) (2)

Volandera

Guarda-polvos de la cureña (1/5)

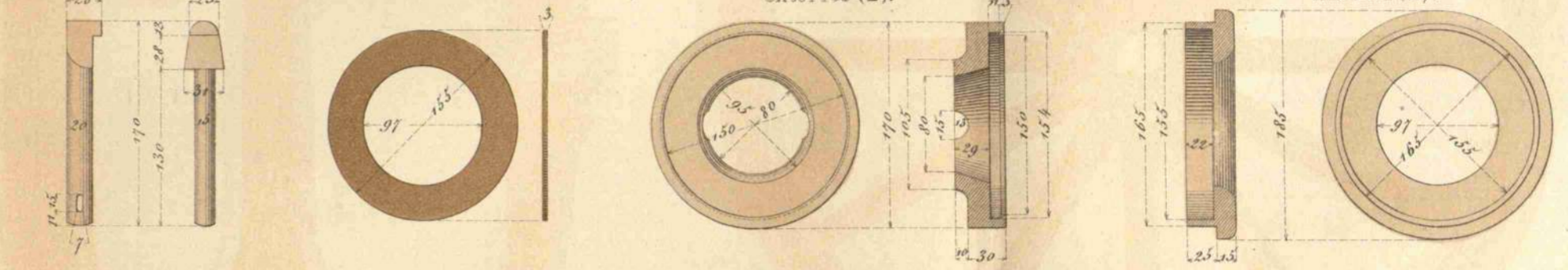

Buje y platillo exterior (2) (1/5) (avantren)

Platillo interior (2) (1/5) (avantren)

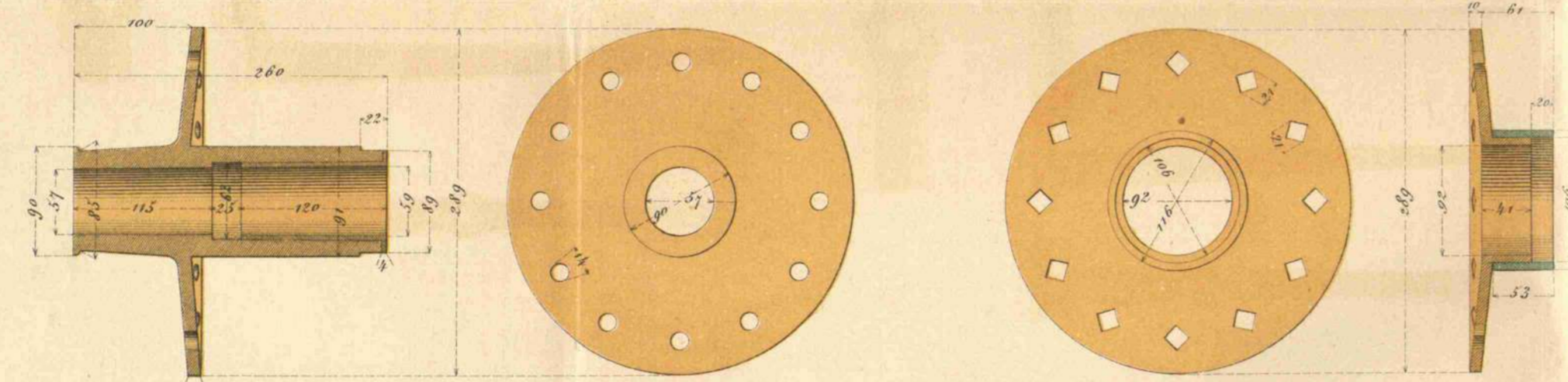

Soporte anterior del estribo (2) (1/5)

Soporte posterior del estribo (2) (1/5)

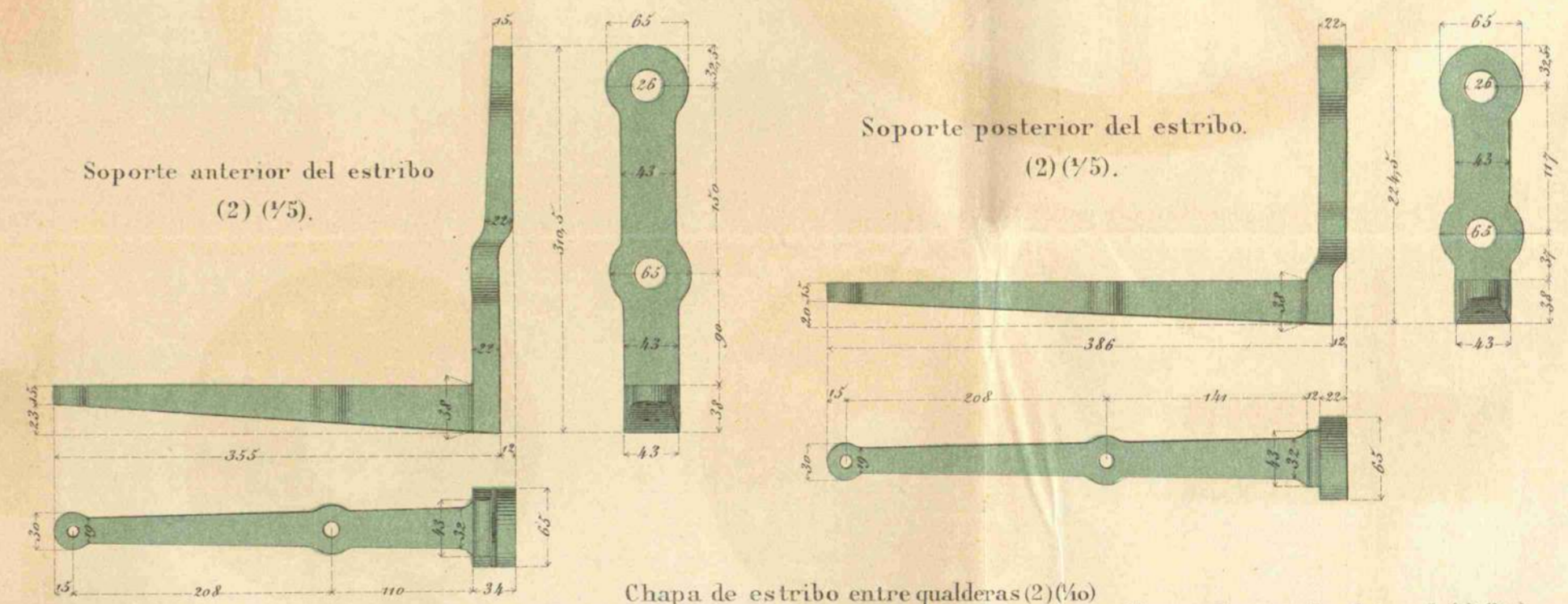

Eje del avantren (1/10)

Fernos pasantes (2) (2/5)

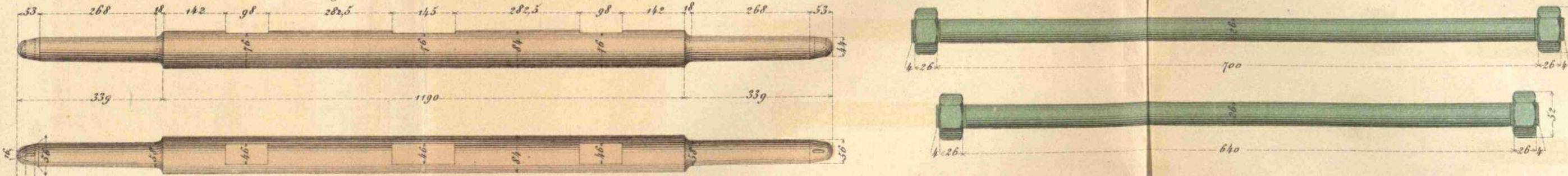

Chapa de estribo entre qualderas (2) (1/10)

Chapa de estribo lateral (2) (1/10)

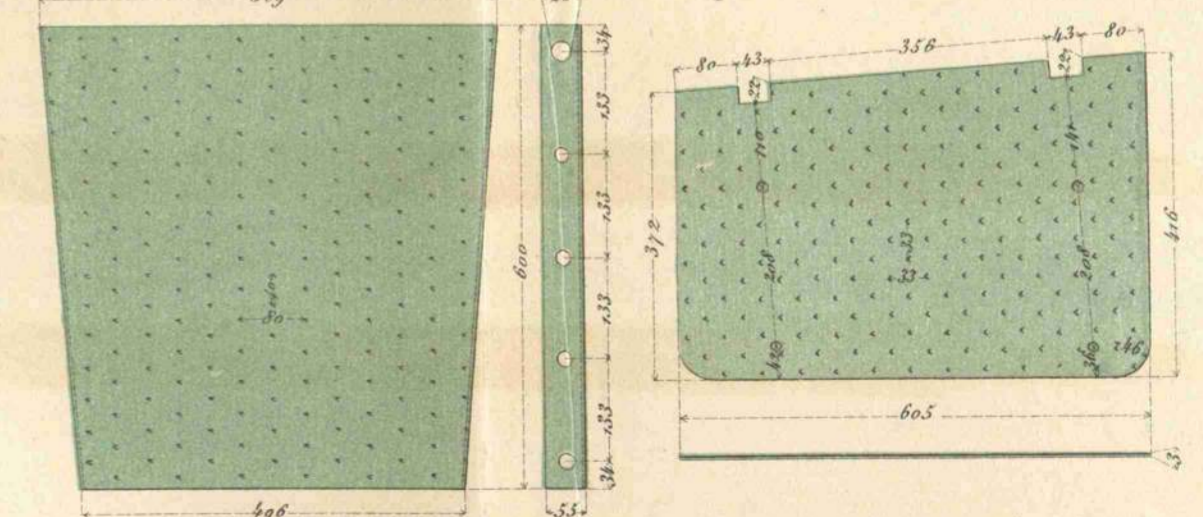

Guarda-polvos del avantren.

Sotrozo (avantren) (2) (2/5)

Estuche del punzon (2/5)

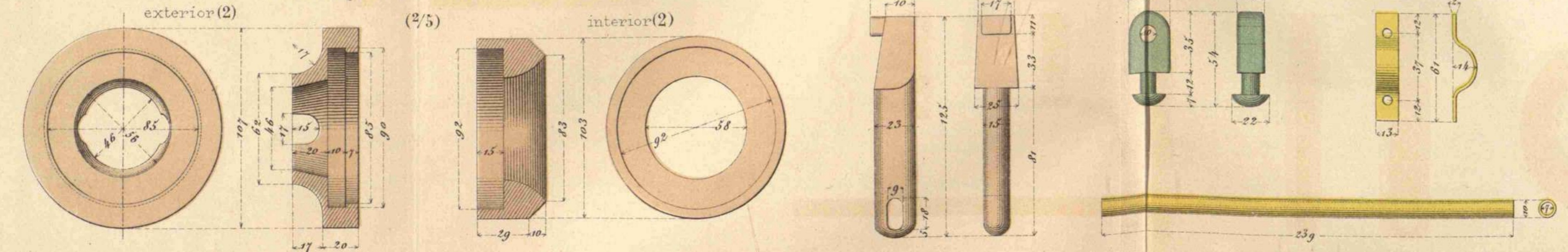

NOTAS - 1ª La rueda de esta cureña se ha publicado en la lámina 54 série B.  
2ª Los detalles del avantren que no figuran en esta lámina, están en la 52 série B.







**MATERIAL DE PLAZA COSTA Y SITIO.**  
**LANZA PARA AVANTREN DE CUREÑA DE CHAPA MD. 1881 PARA C. B. 14. Cc.**  
 L.z. Av. Cña. Ch. Md. 1881. C. B. 14. Cc.

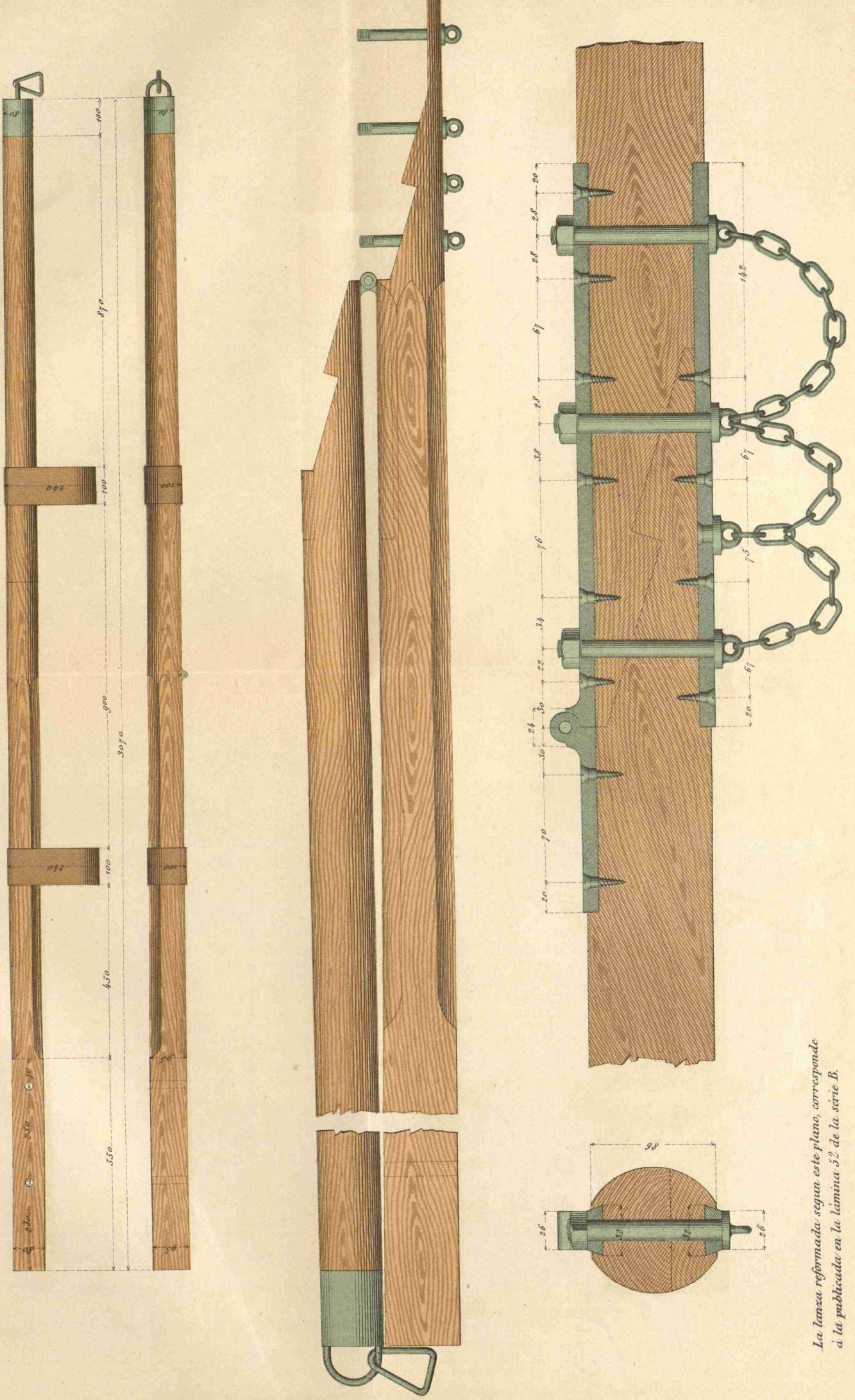

*La lanza reformada segun este plano, corresponde á la publicada en la lamina 52 de la serie B.*



# MATERIAL DE PLAZA COSTA Y SITIO.

## DISPOSICION DE LA AMETRALLADORA MONTIGNI EN CASAMATA PARA LA DEFENSA DE LOS FOSOS.

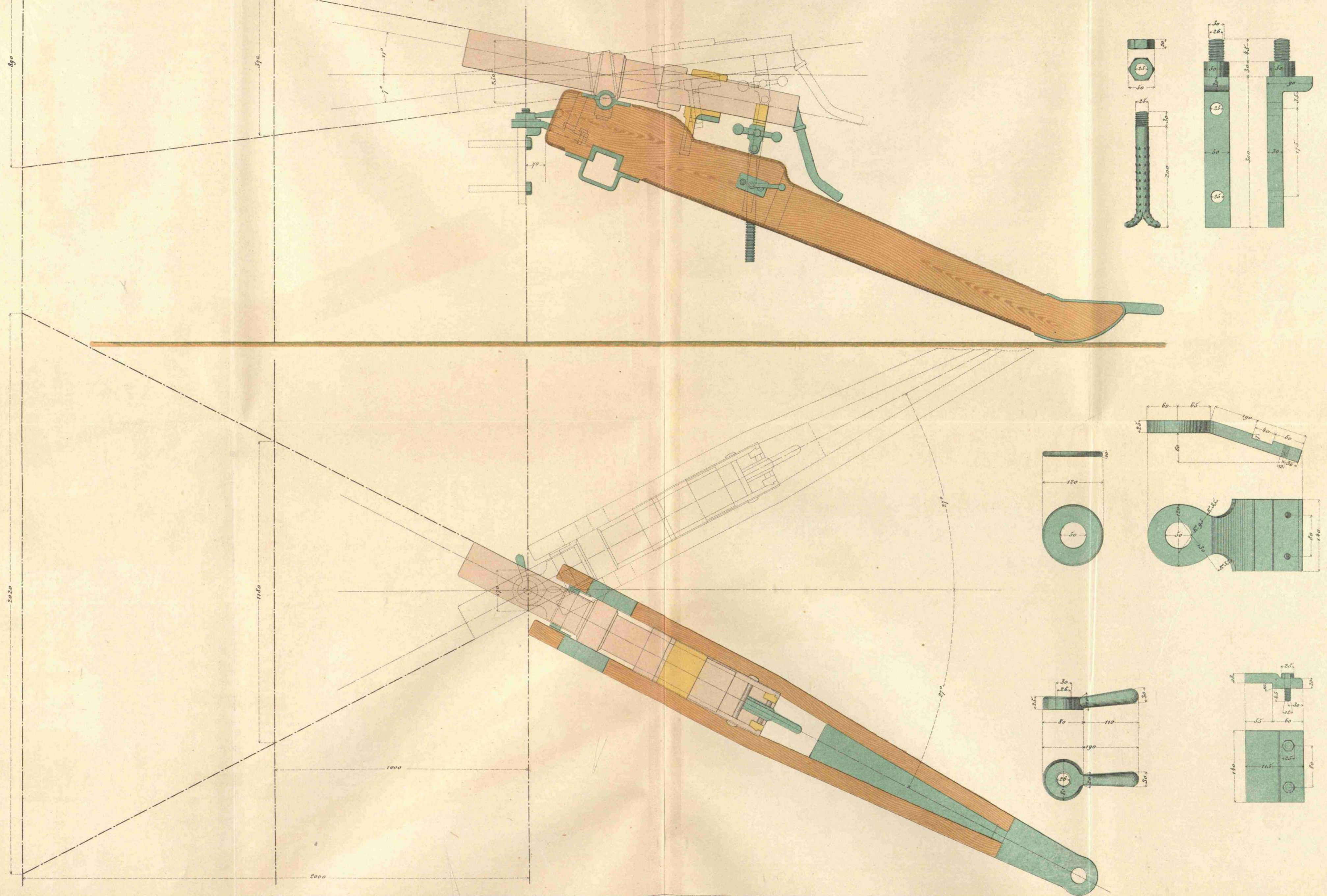



# MATERIAL DE PLAZA COSTA Y SITIO.

## TRANSFORMACION DEL MONTAGE PARA O. H. R. S. DE 21 DE GIRO ANTERIOR EN GIRO CENTRAL.

Escala 1/15.

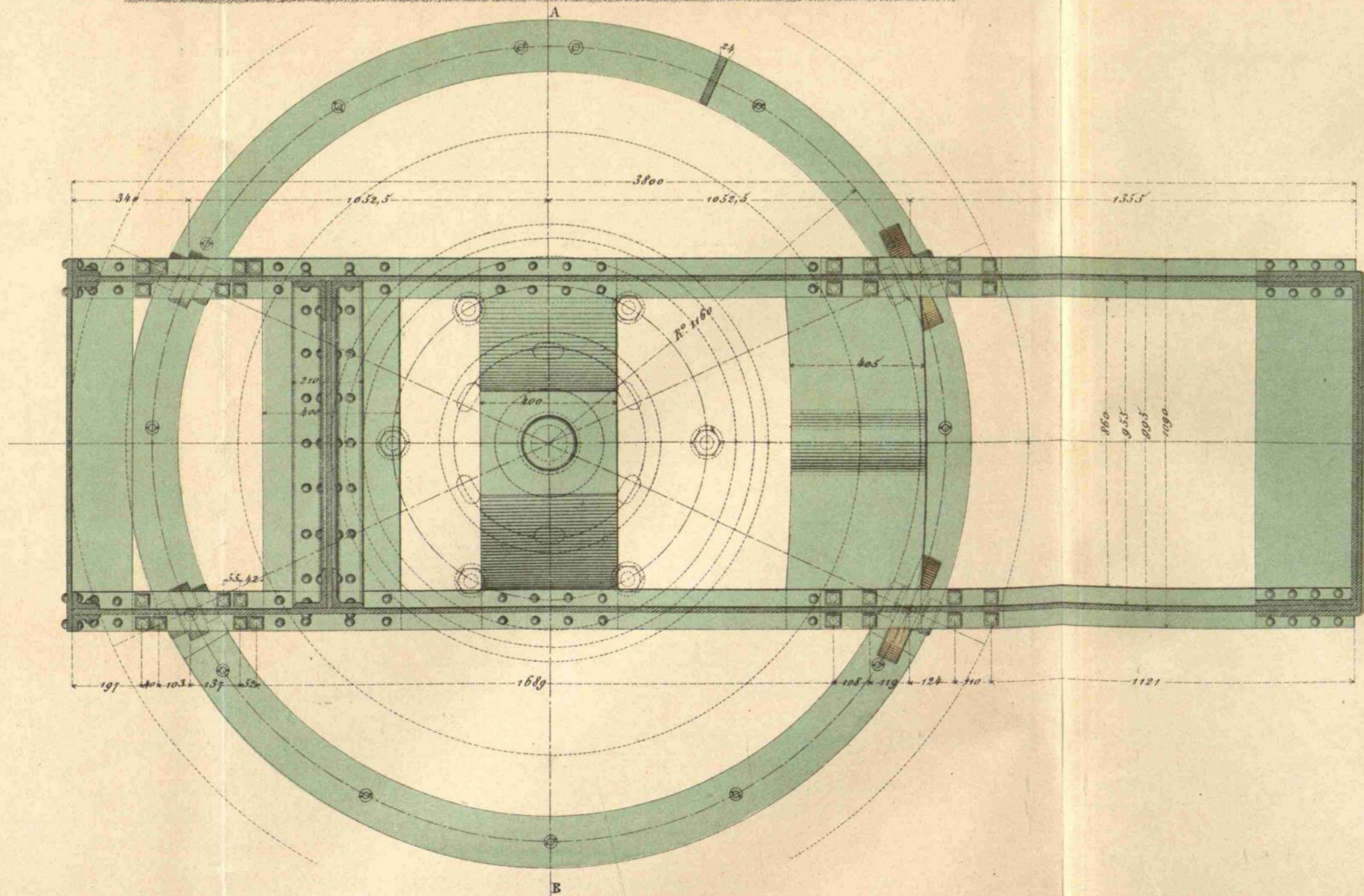
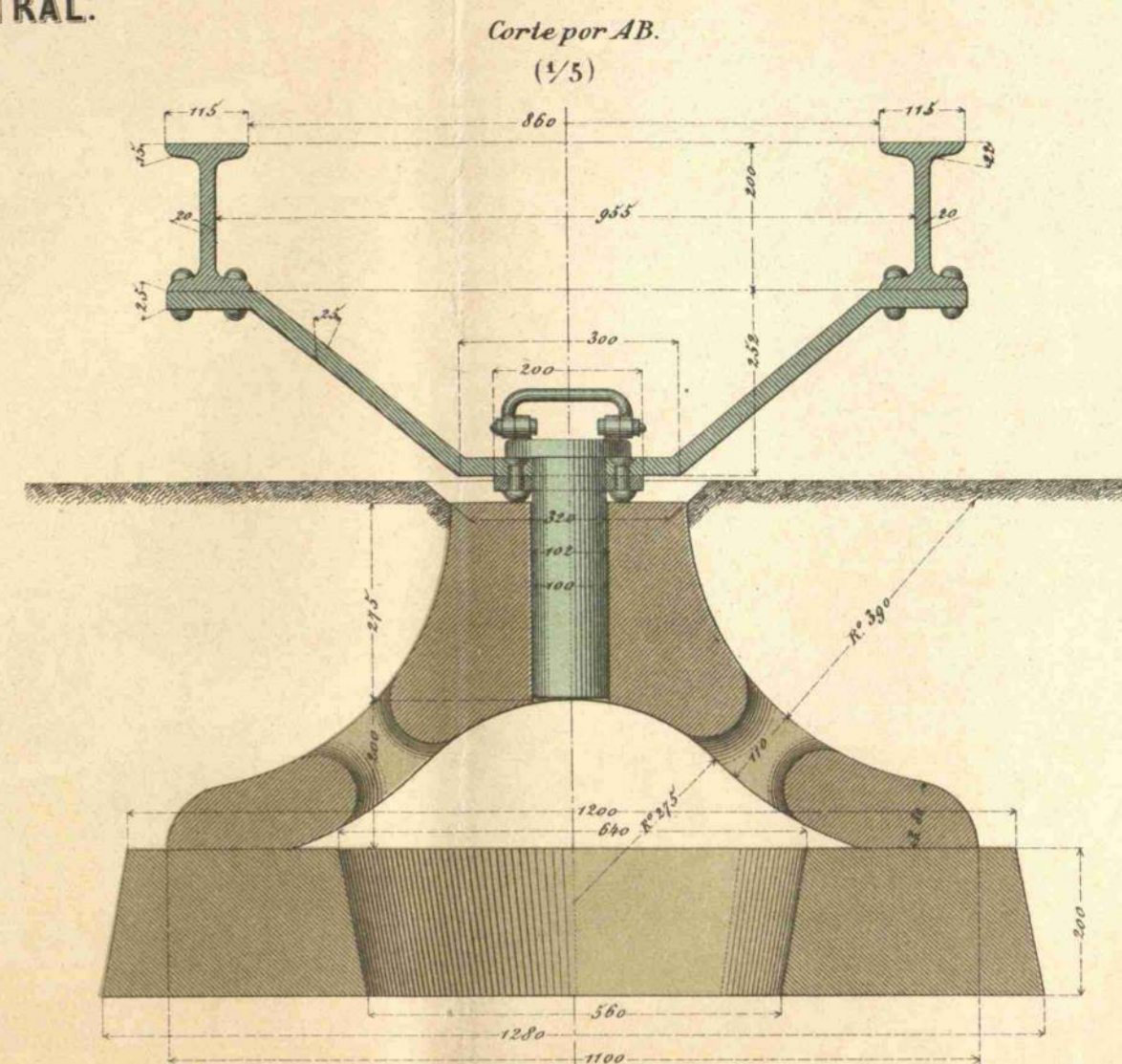
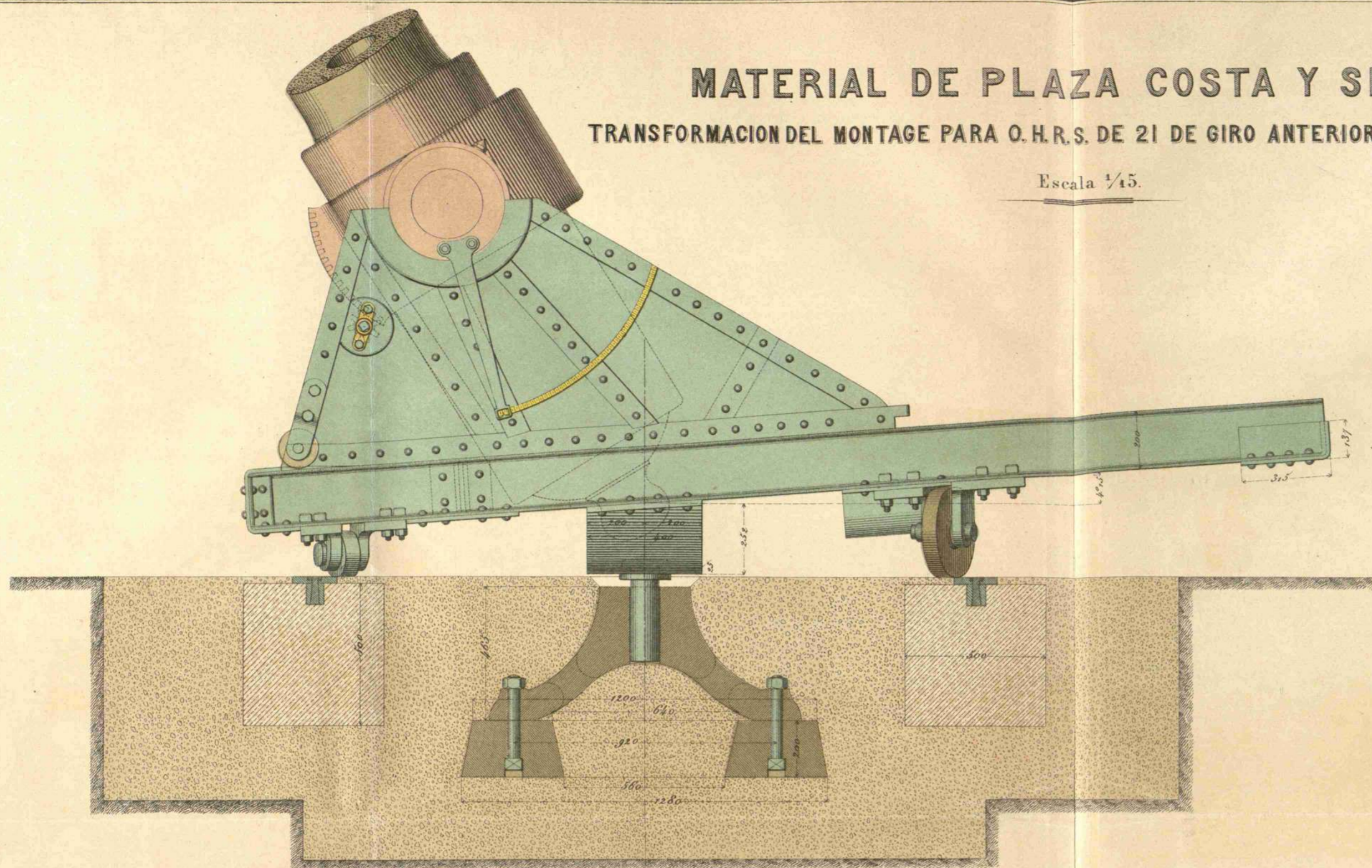

Proyeccion horizontal de la basa.

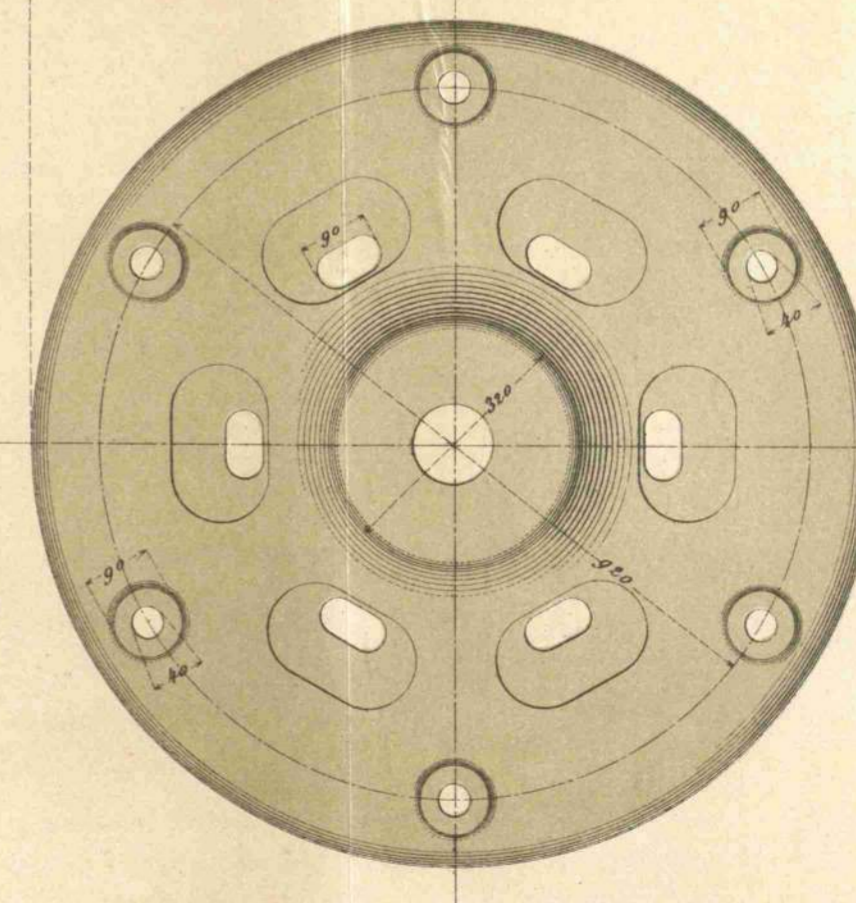



# MATERIAL DE PLAZA COSTA Y SITIO.

## TRANSFORMACION DEL MONTAGE PARA O.H.R.S. DE 21. DE GIRO ANTERIOR EN GIRO CENTRAL.

### DETALLES.

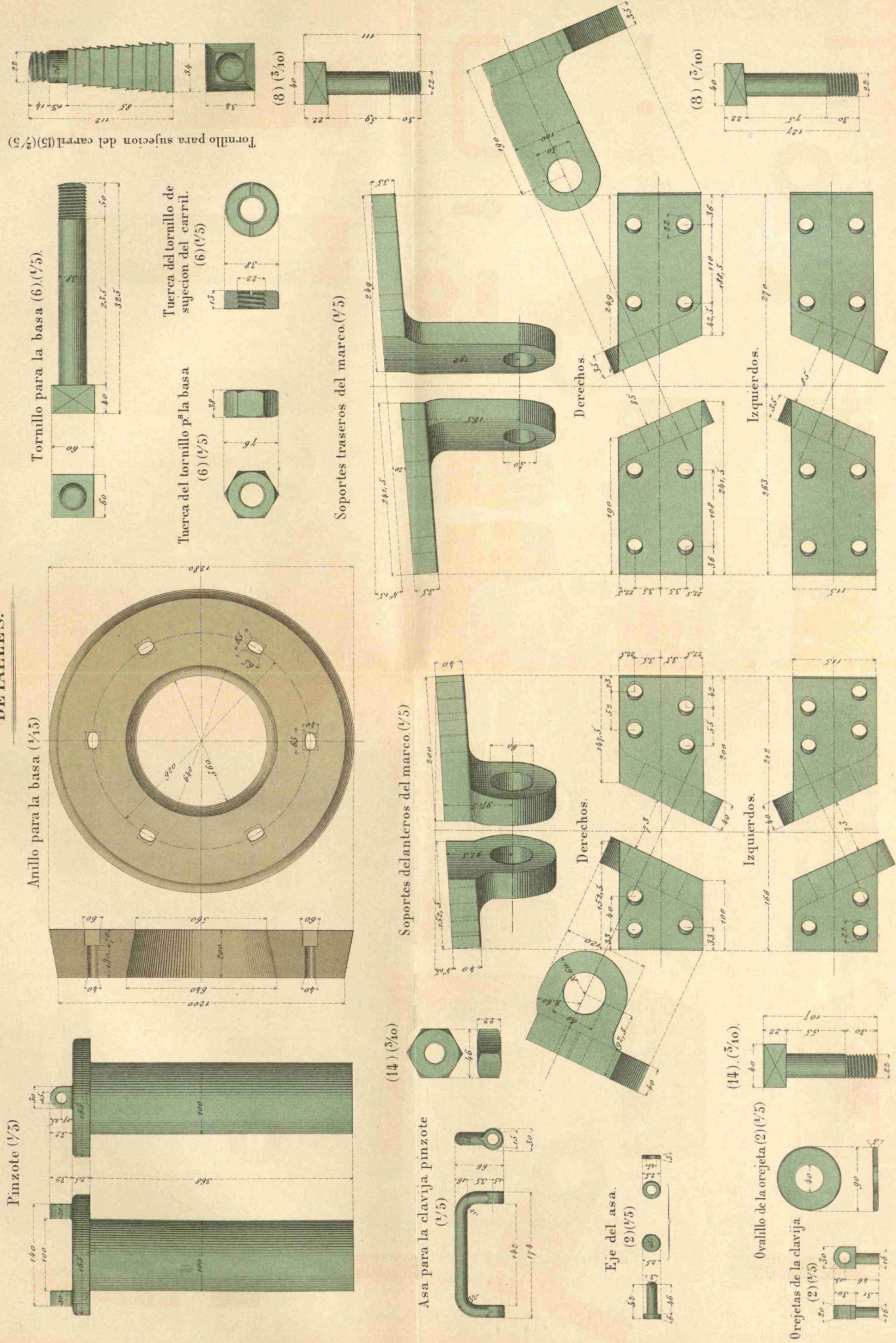







# MATERIAL DE PLAZA COSTA Y SITIO. TRUC DE 30 TONELADAS MODELO 1887.

DETALLES.

Escala 1/5.

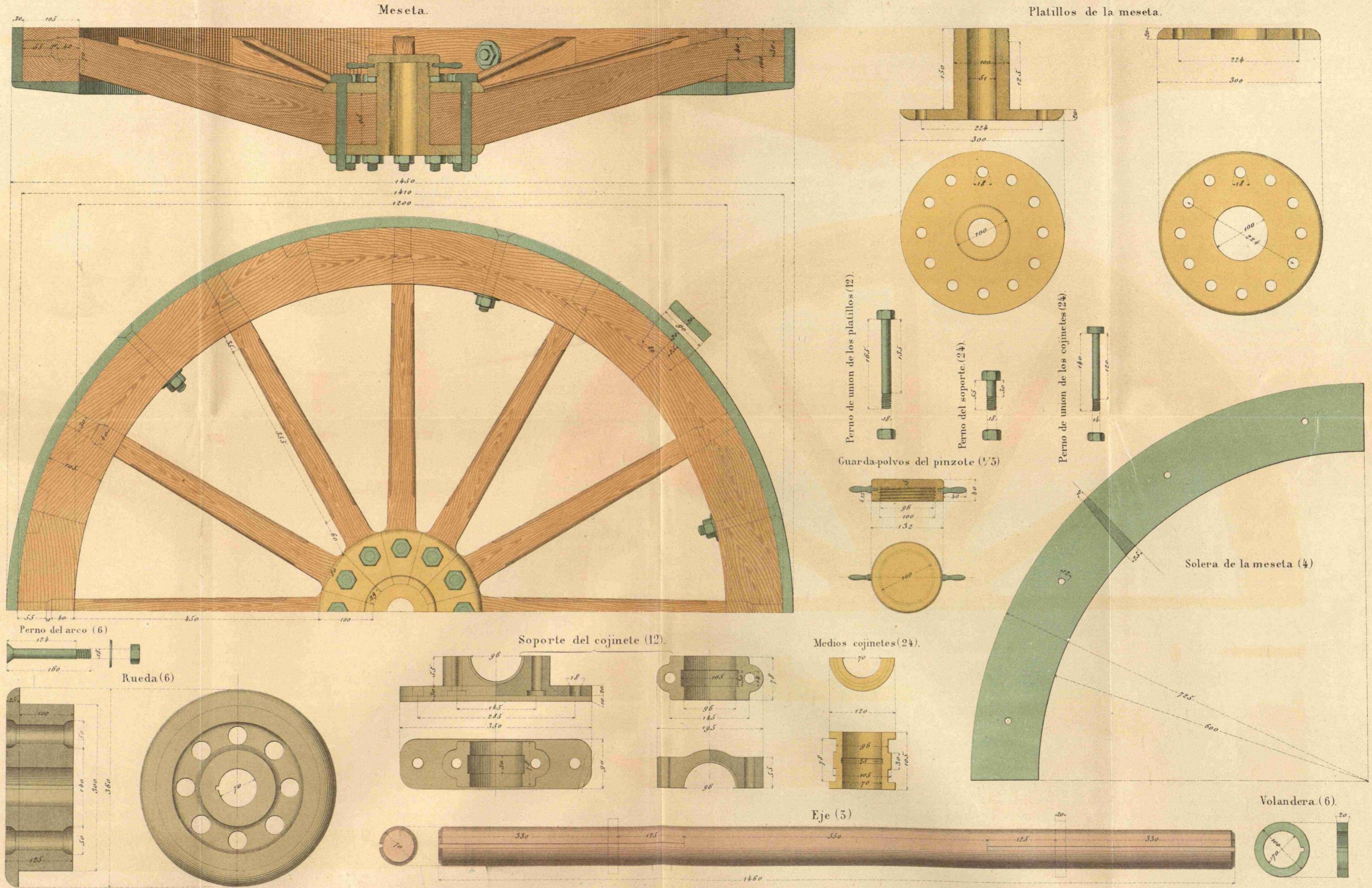



**MATERIAL DE PLAZA COSTA Y SITIO.**  
**TRUC DE 15 TONELADAS MODELO DE 1887. (TRUC DE 15 t MD.1887)**  
 COMPONENTE DE LA PAREJA PARA TRANSPORTAR PIEZAS HASTA DE 50 t.

Escala 1/10.

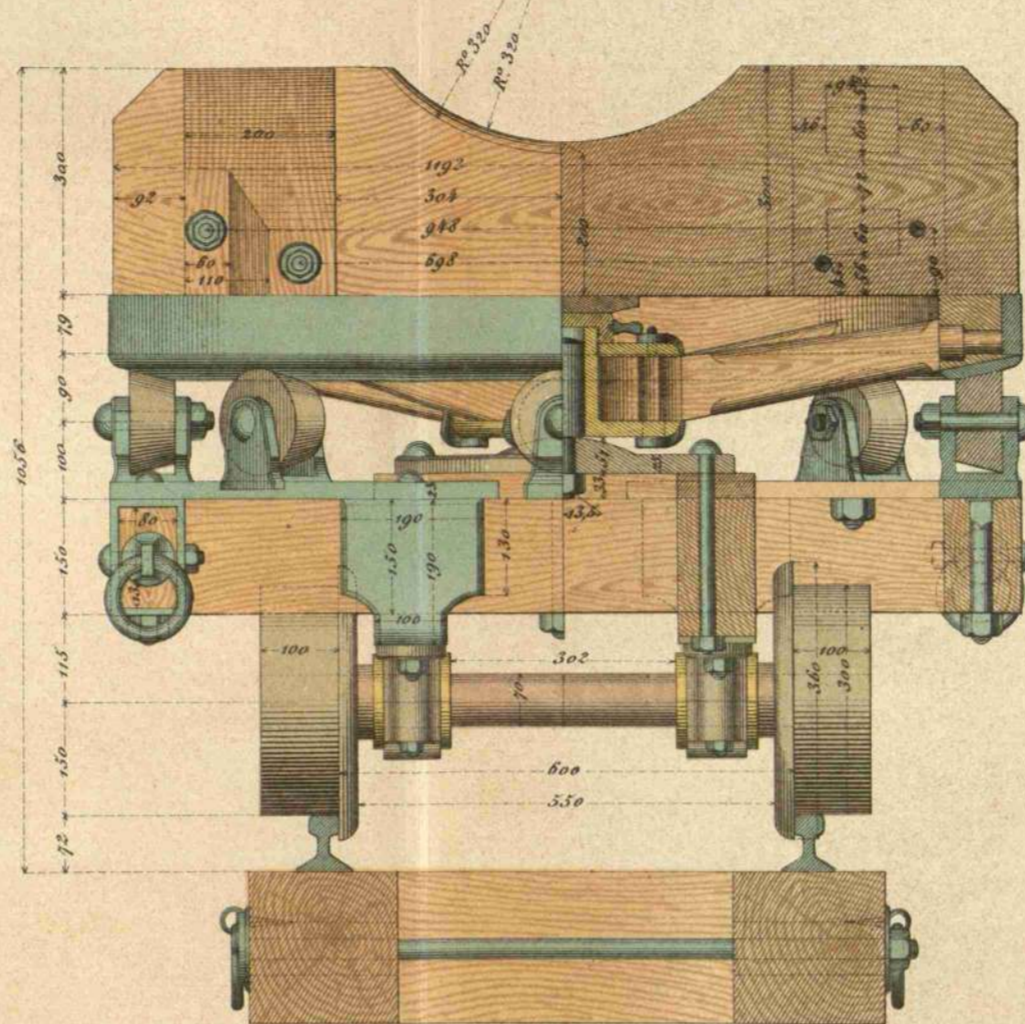
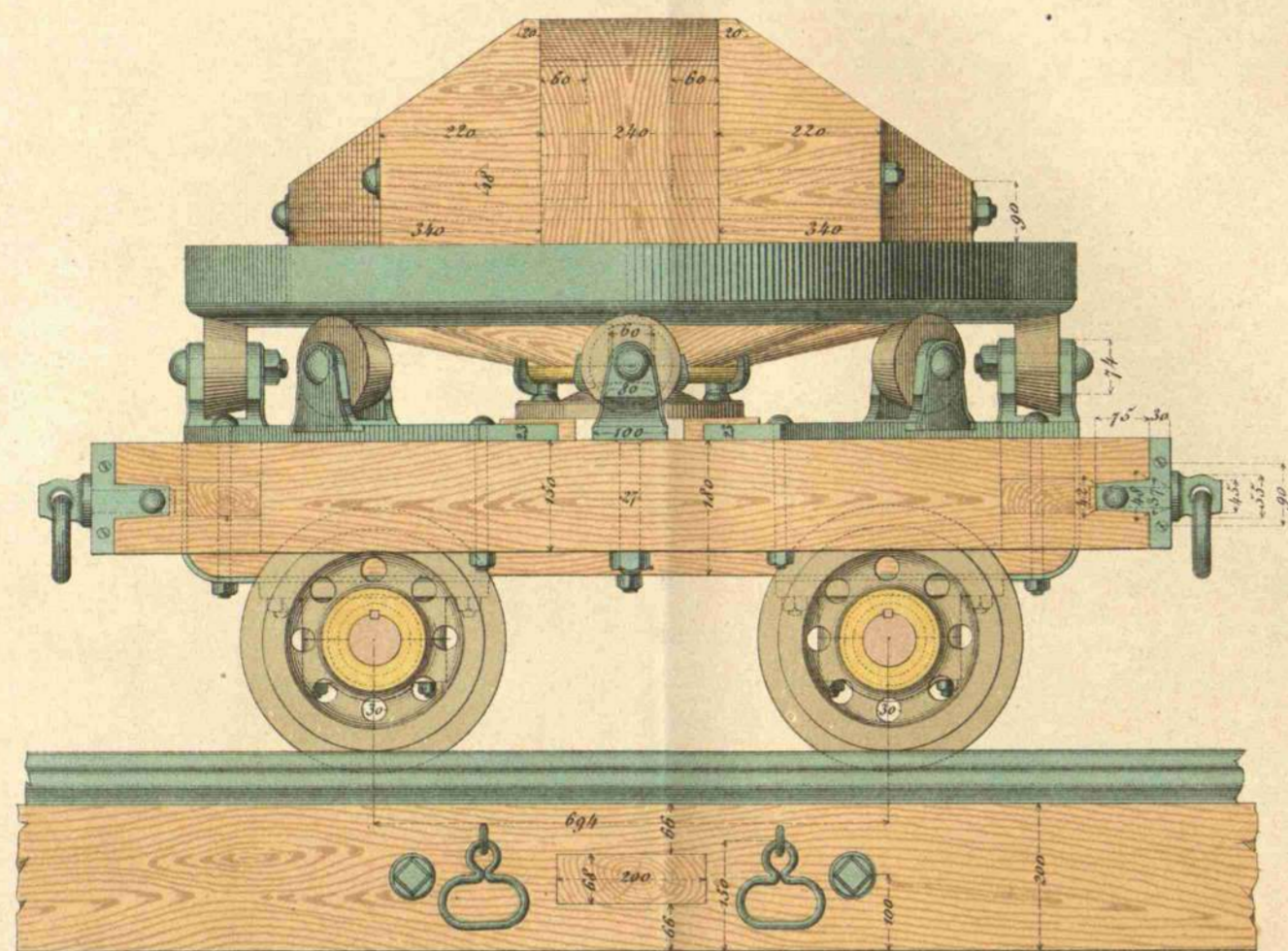

Detalles de la meseta giratoria (1/5)

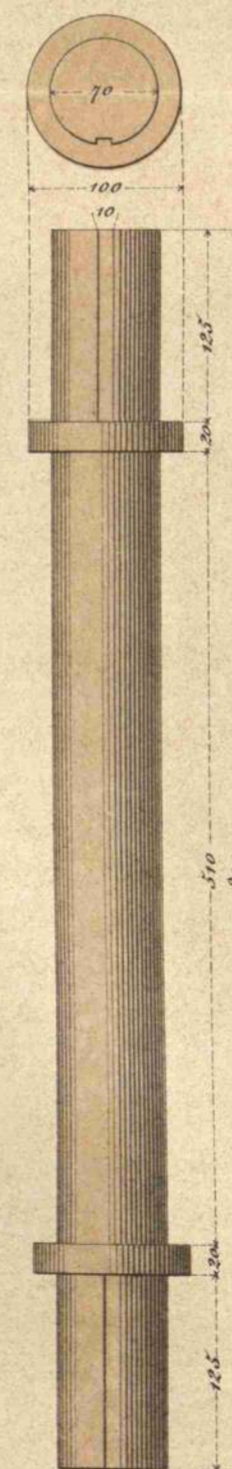
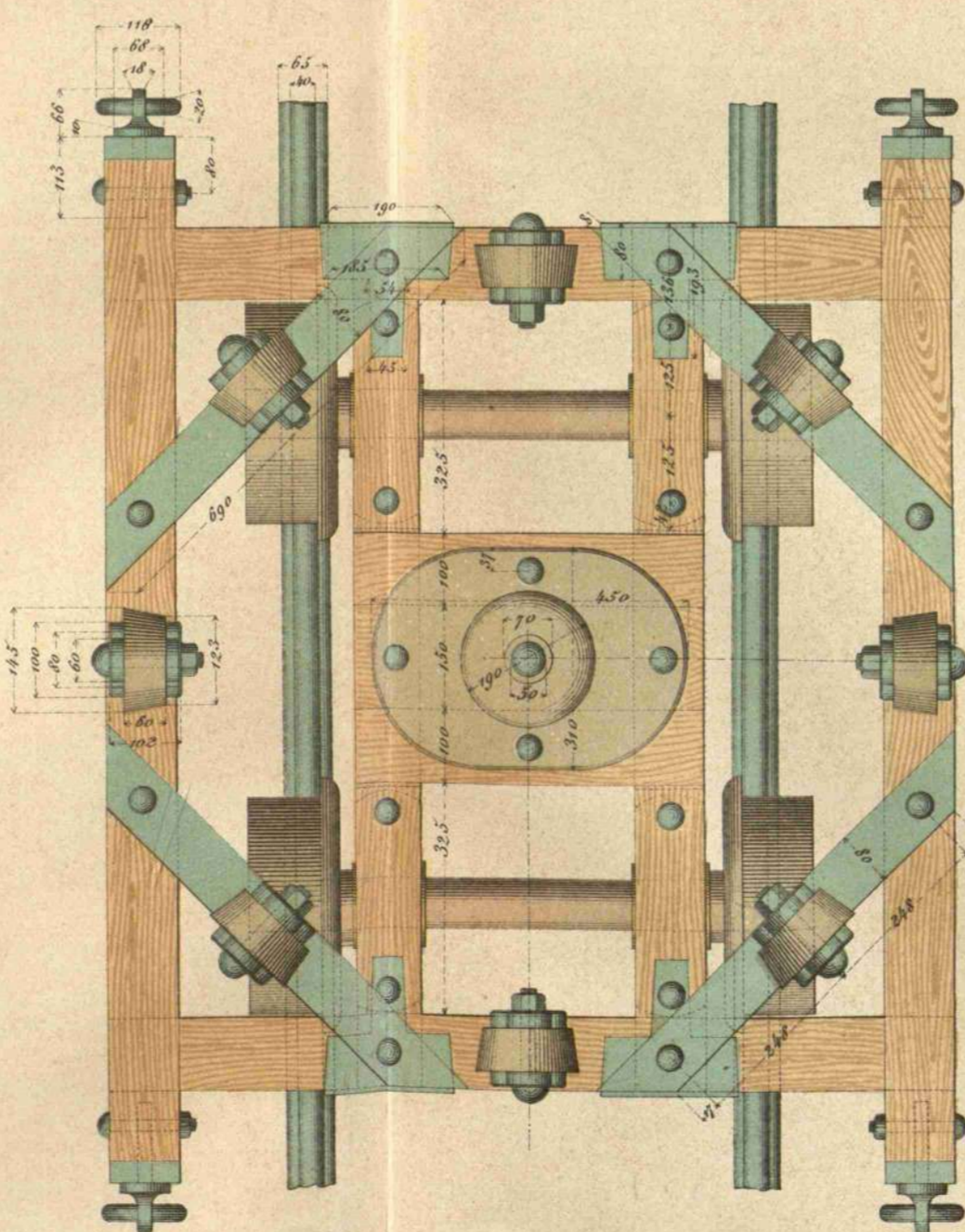
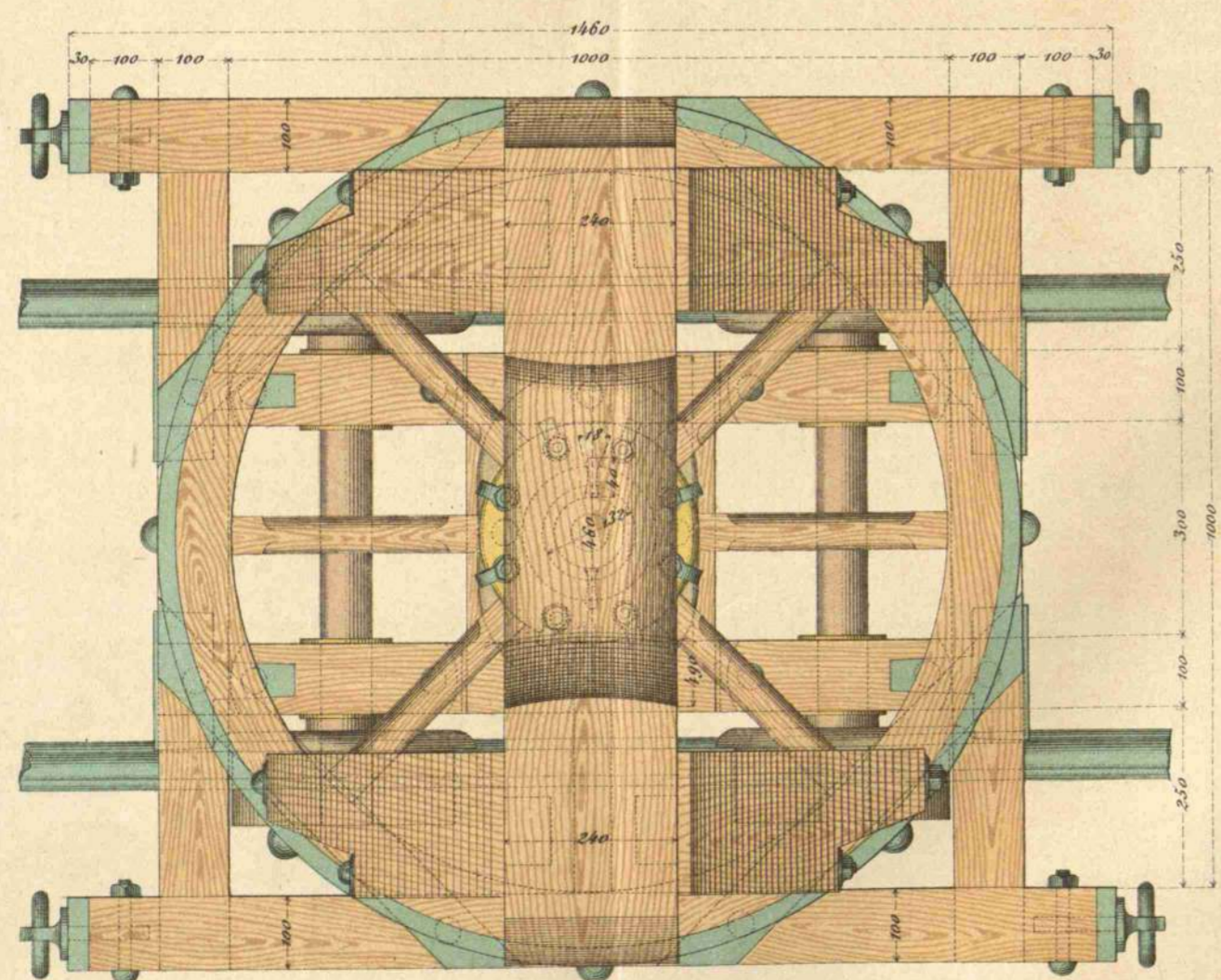
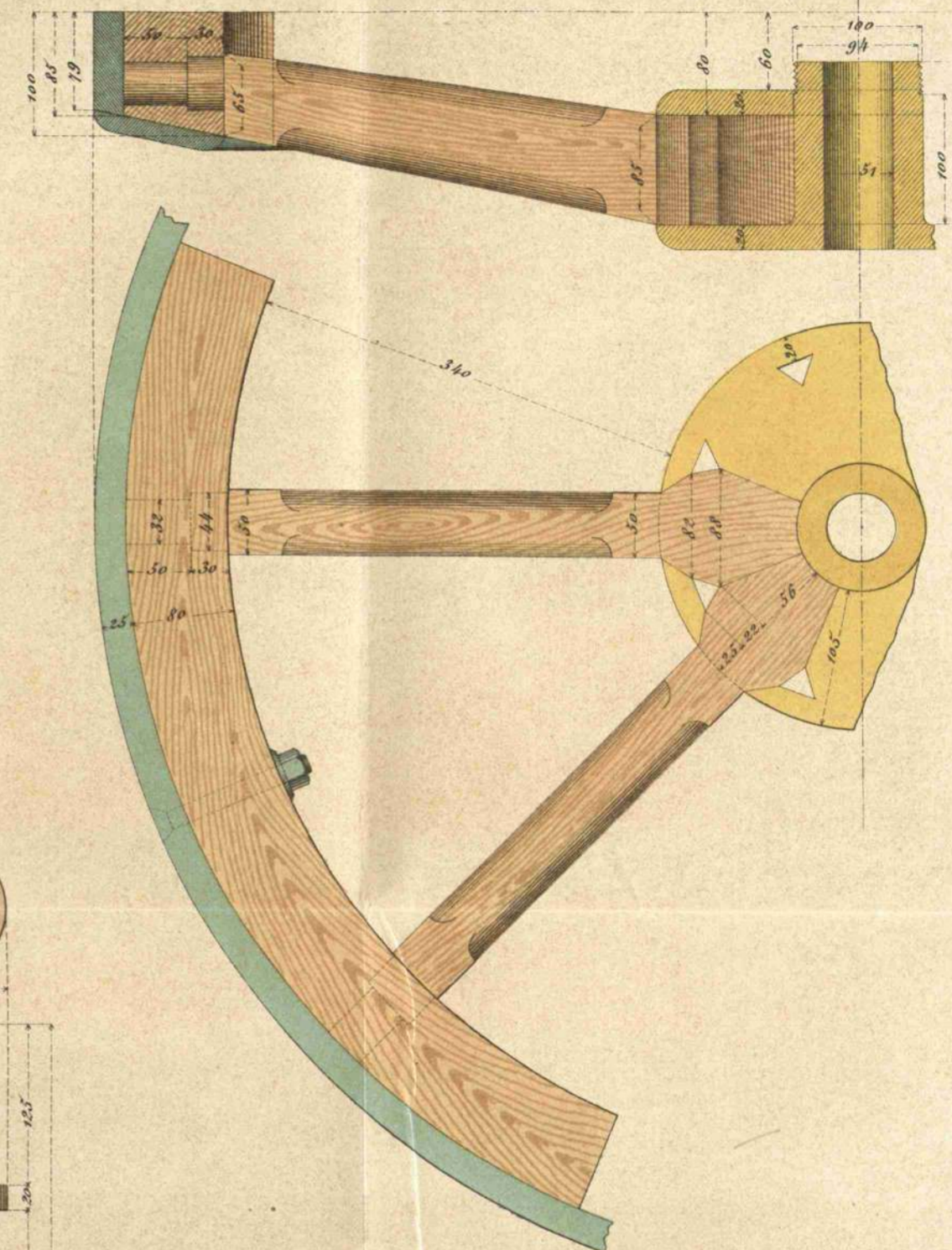

Peso del truc ..... 705 Kg  
 Id. del soporte ..... 75 "  
 Id. de la meseta ..... 190 "

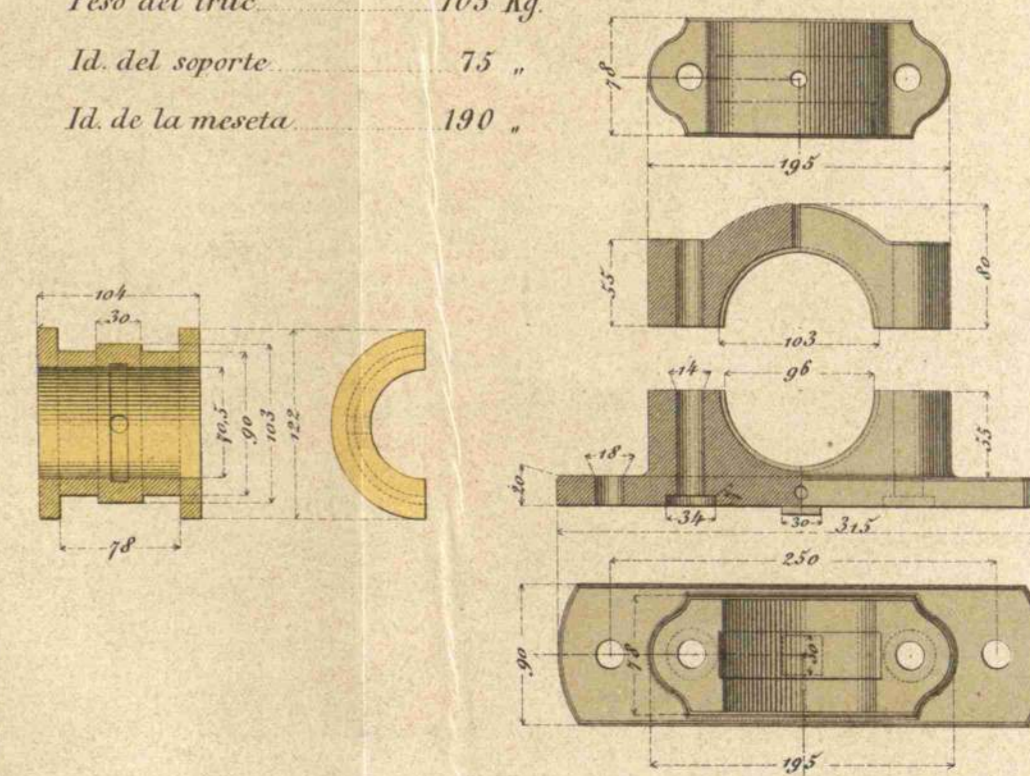



# MATERIAL DE PLAZA COSTA Y SITIO. TRUC DE 15 TONELADAS MODELO 1887.

## DETALLES.

Batea (1/10).

Soporte doble (1/10).

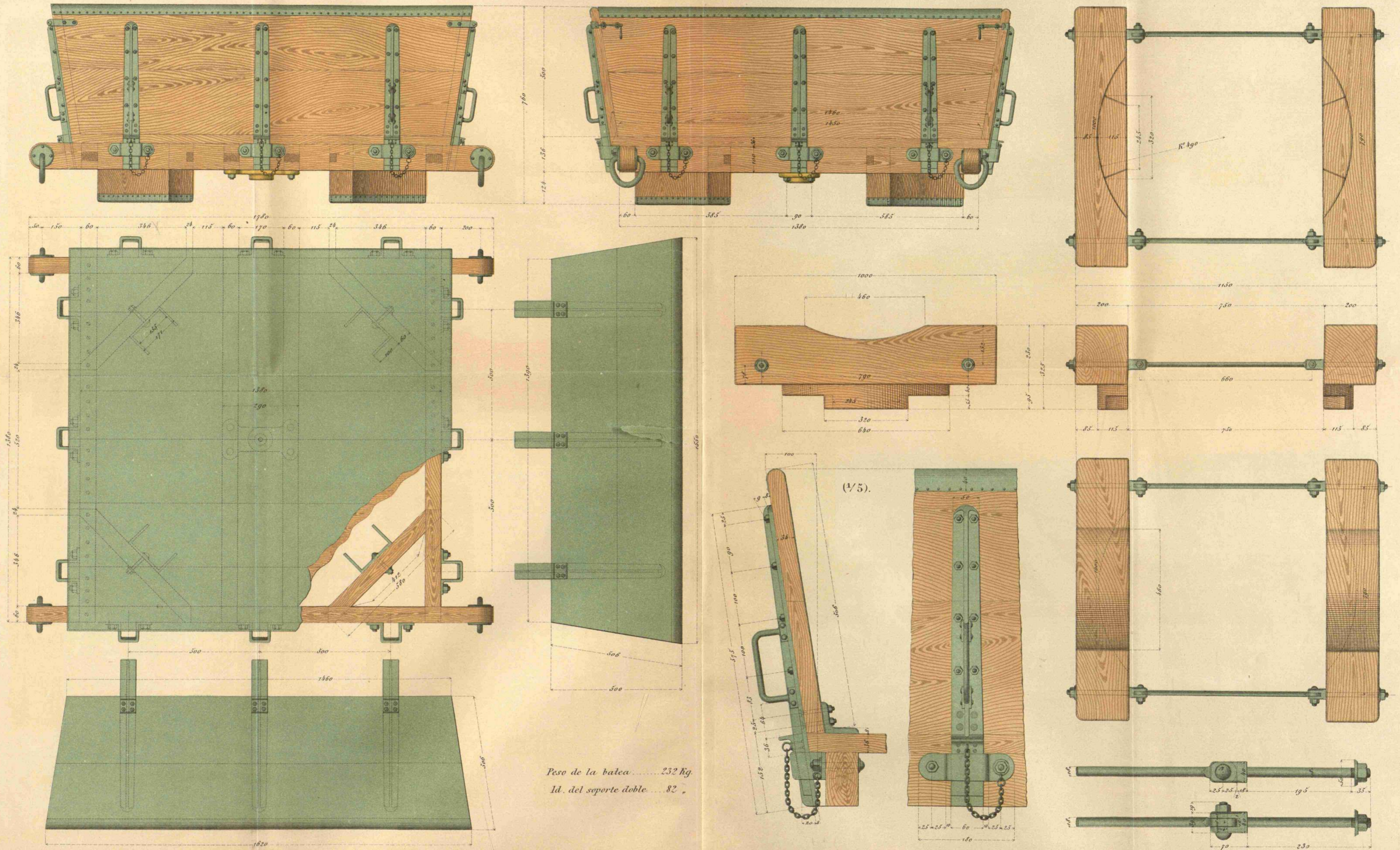

Peso de la batea ..... 232 Kg.  
Id. del soporte doble ..... 82 "







# MATERIAL DE PLAZA COSTA Y SITIO.

TRUCS DE 15 Y 30 TONELADAS MODELO 1887-PLATAFORMA GIRATORIA PARA LA VIA.  
Escala 1/10.

Plataforma completa.  
Corte por AB.

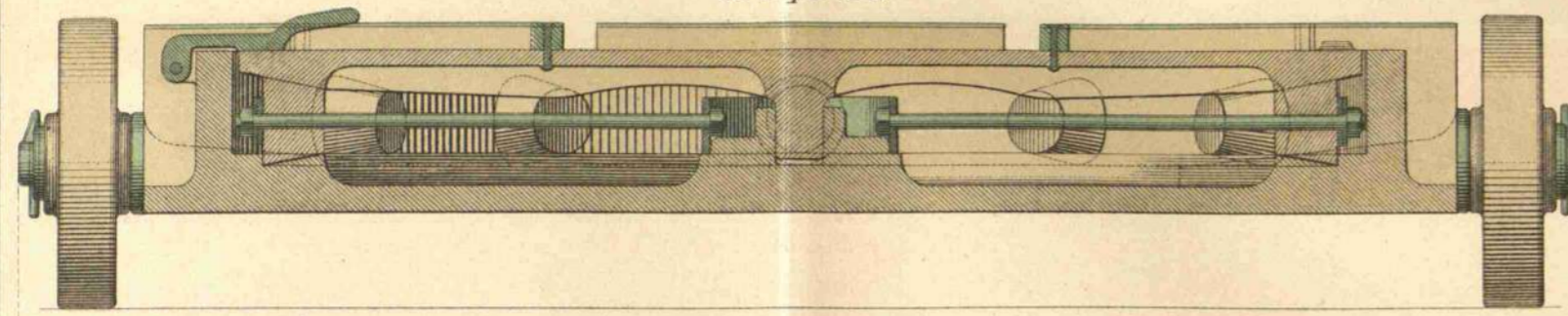

Placa inferior.  
Corte por CD.

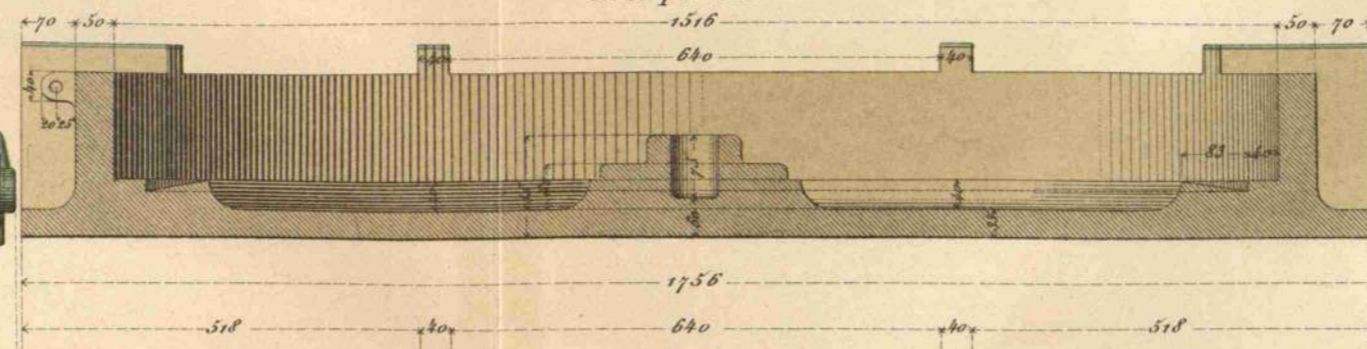

Placa giratoria.  
Corte por AC.

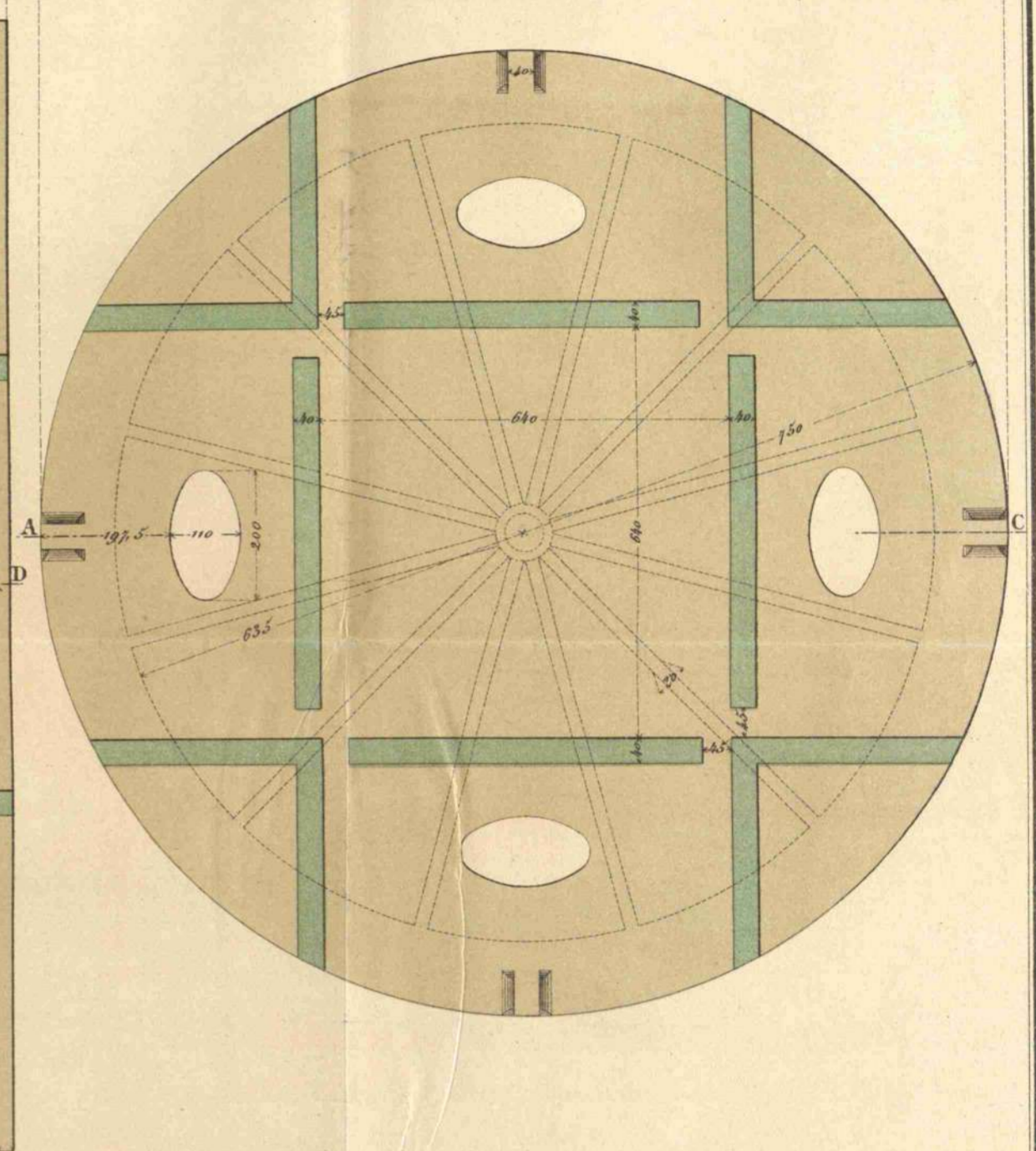
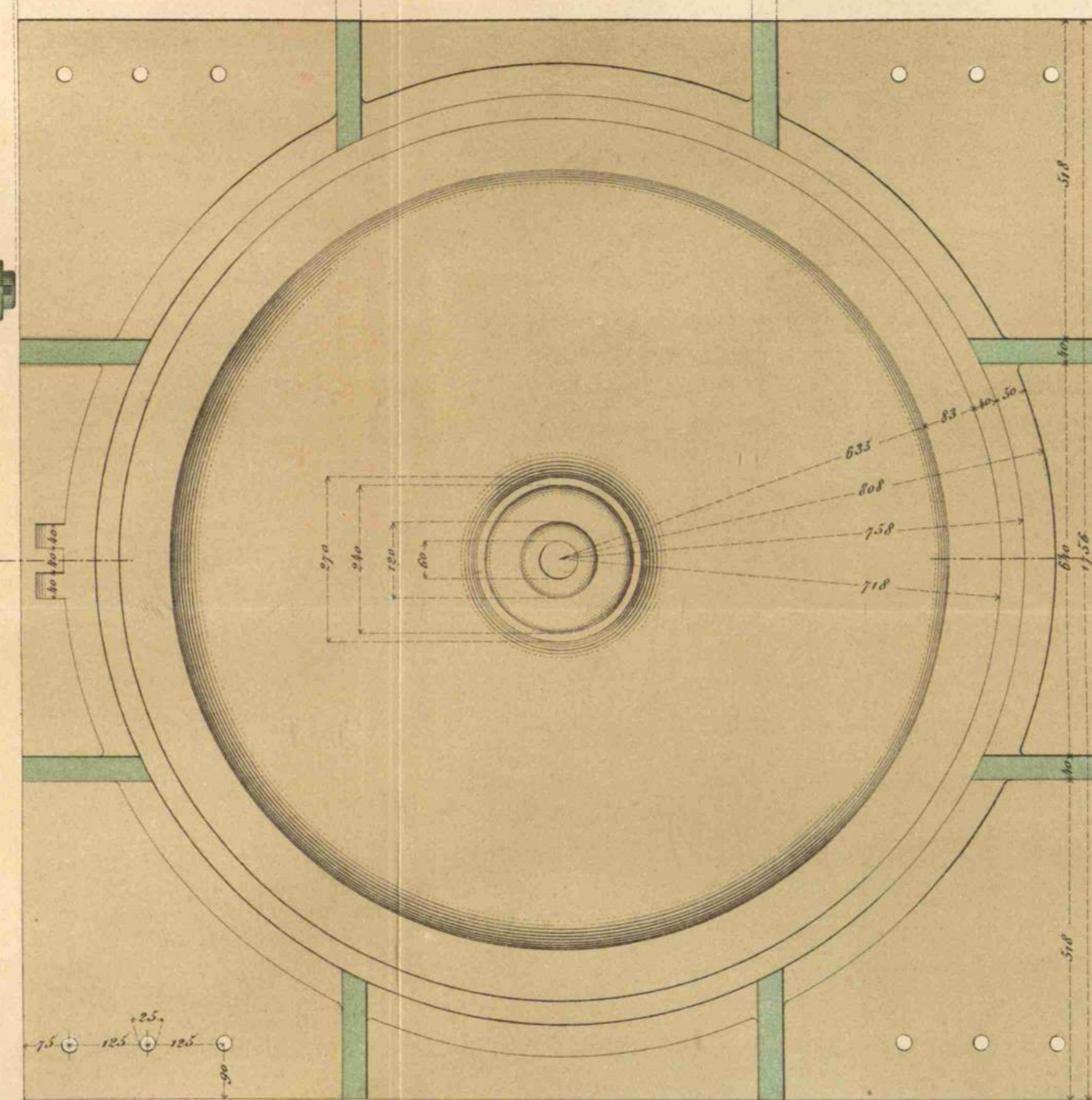
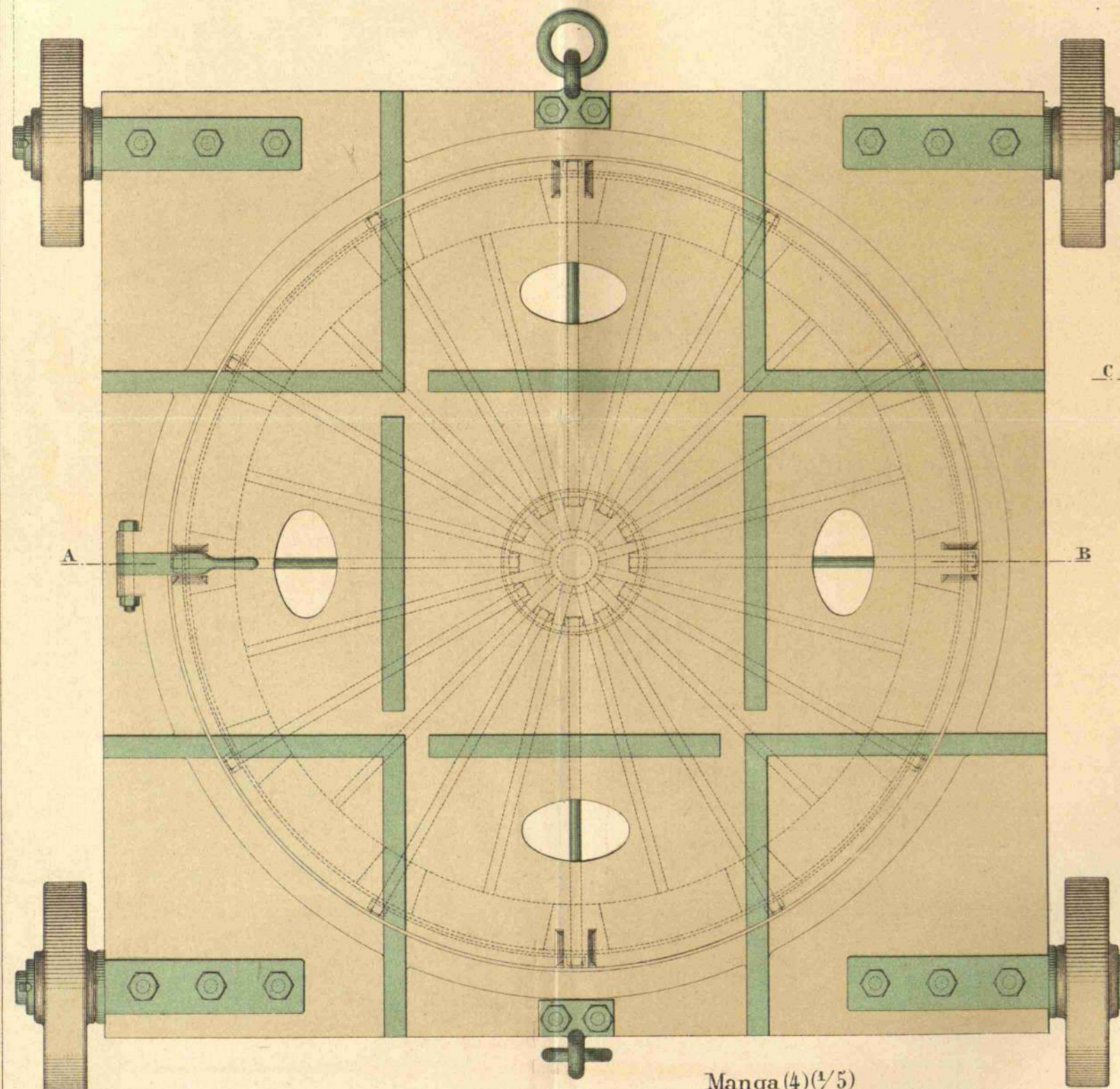
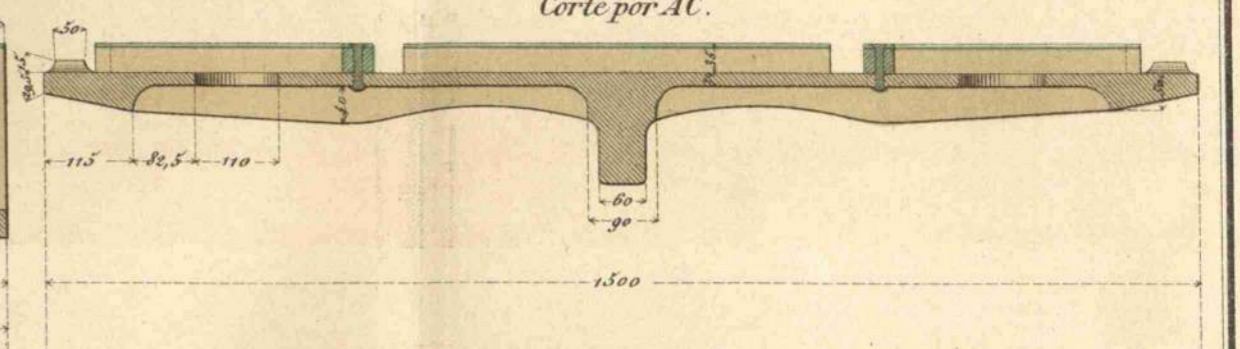

Rueda (4) (1/5)

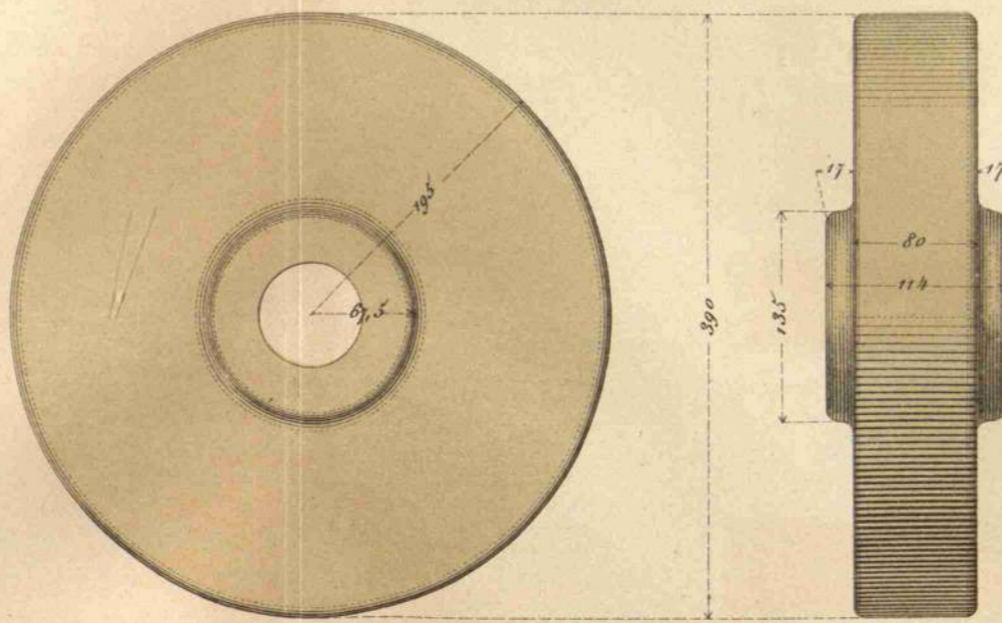

Rodetes con sus ejes y guías.

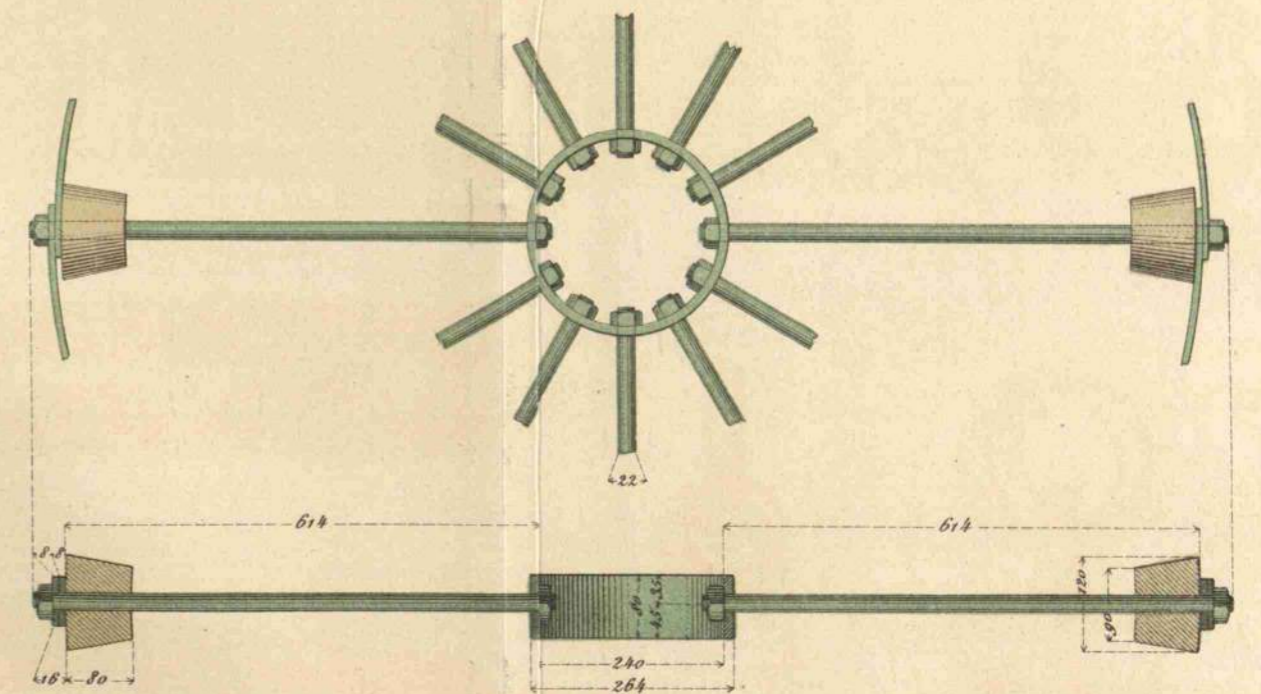

Anilla de enganche (2) (1/5)

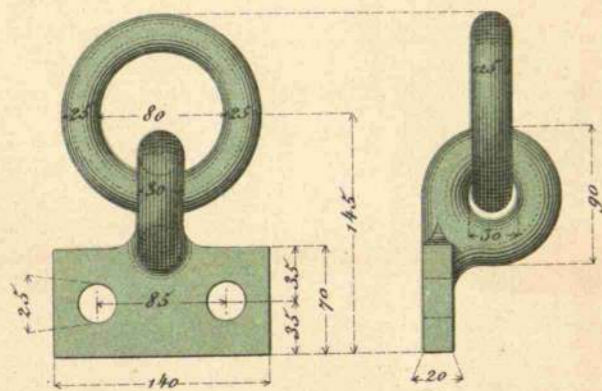

Manga (4) (1/5)

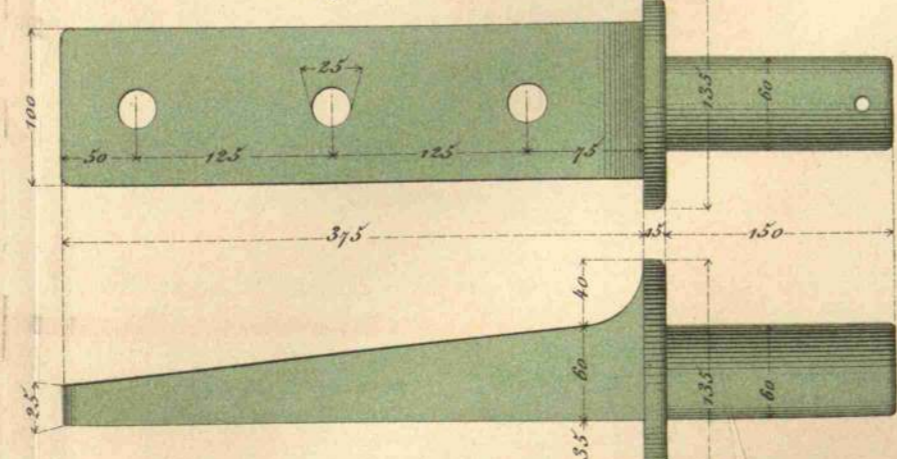















# MATERIAL DE PLAZA COSTA Y SITIO.

Basa del montaje de giro central para cañon hierro sunchado 24. Cc. modelo 1884 (1/20)  
(Basa. M<sup>o</sup>e. giro central C.H.S. 24 Cc.md.1884)

Manivela reformada, para Cábria de Costa modelo 1859 (1/5)  
(Mvl. rf. Cábria. Cst.md.1859)

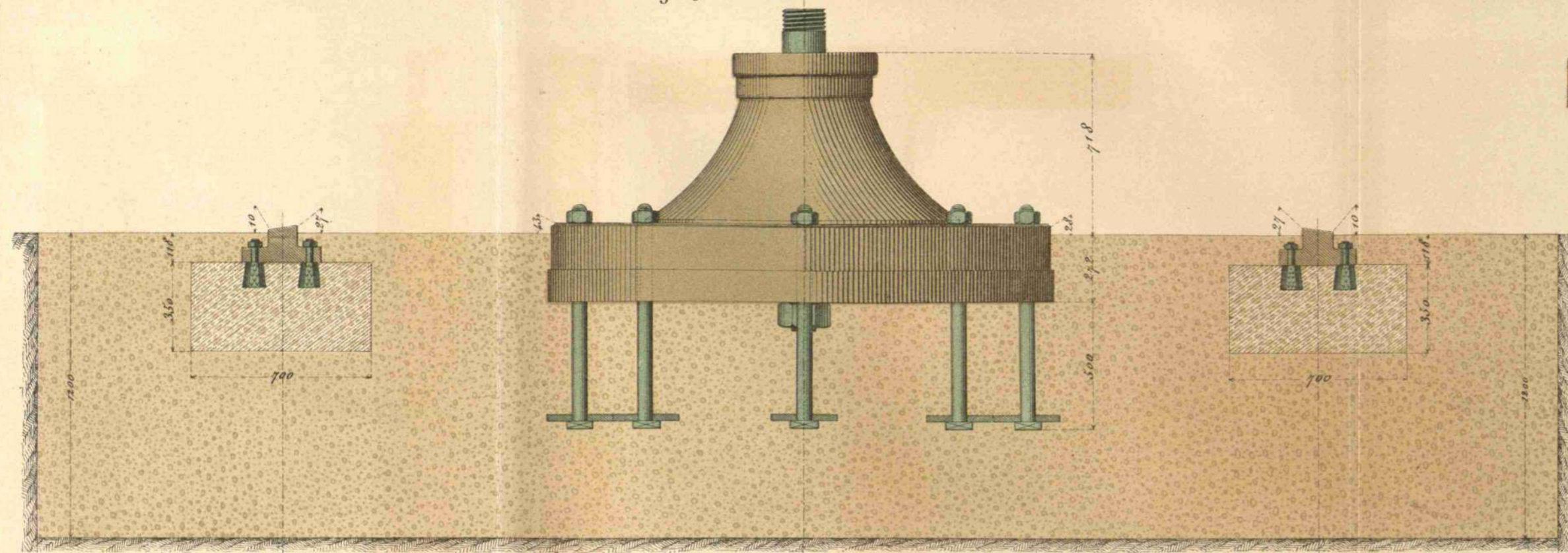

Hormiçon.

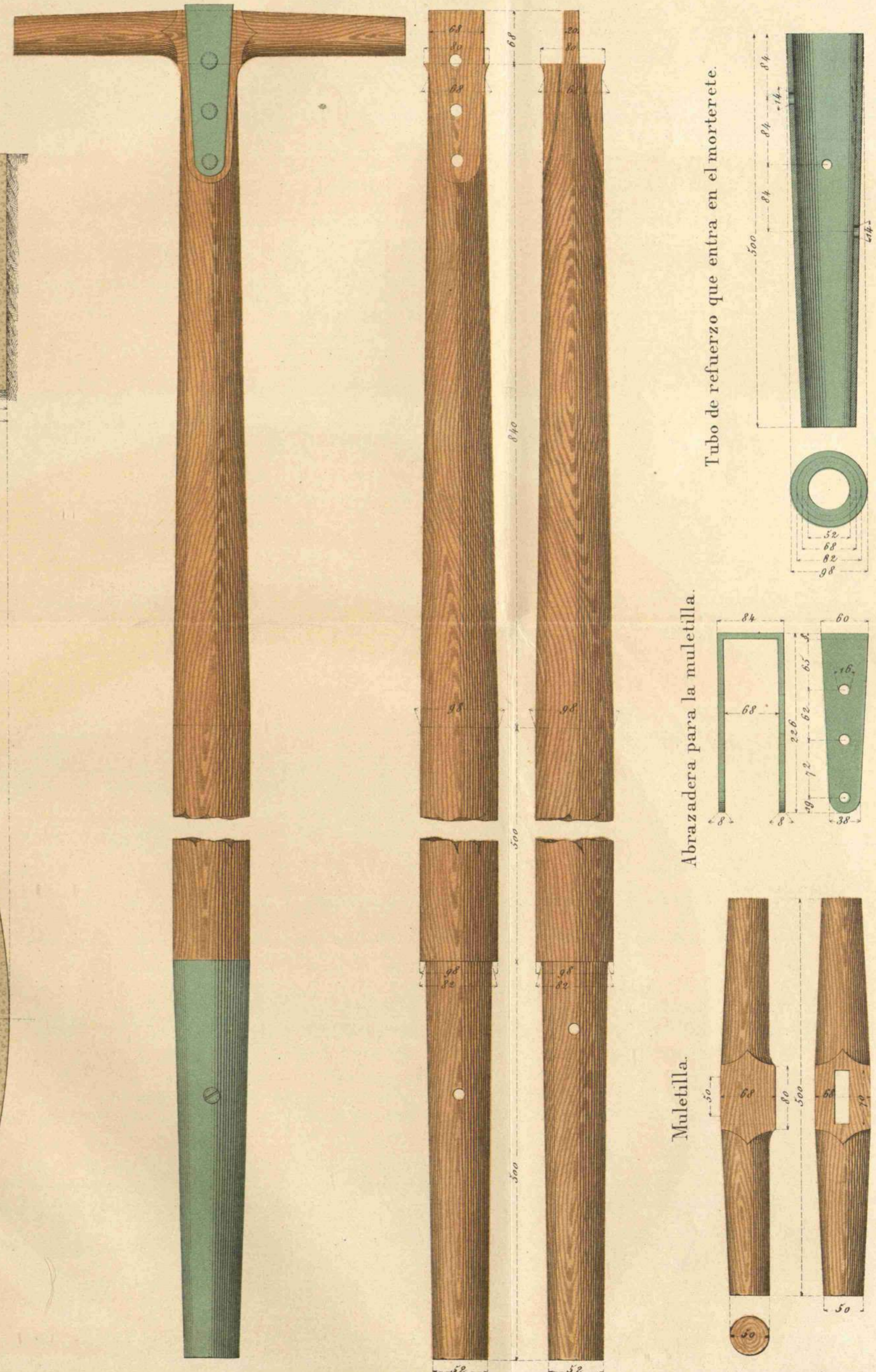
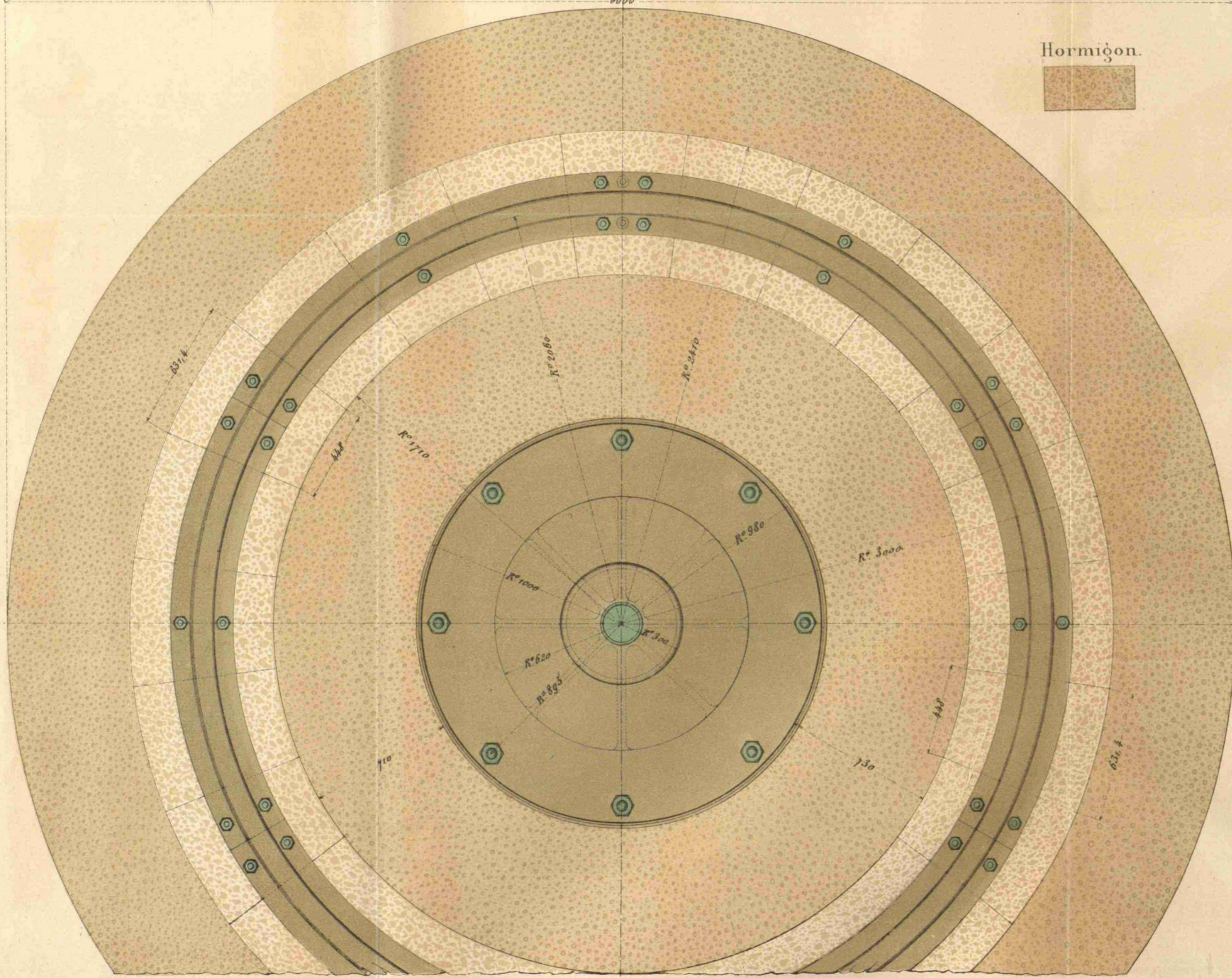

Tubo de refuerzo que entra en el morterete.

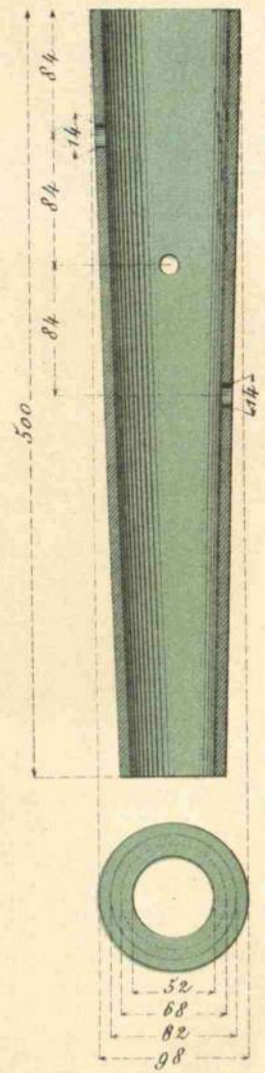

Abrazadera para la muletilla.

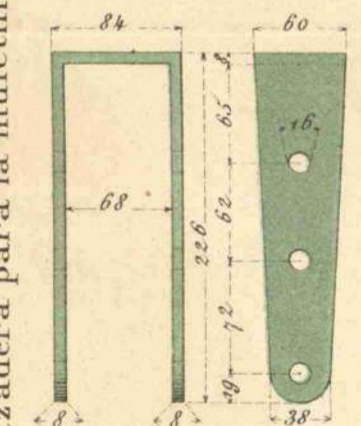

Muletilla.

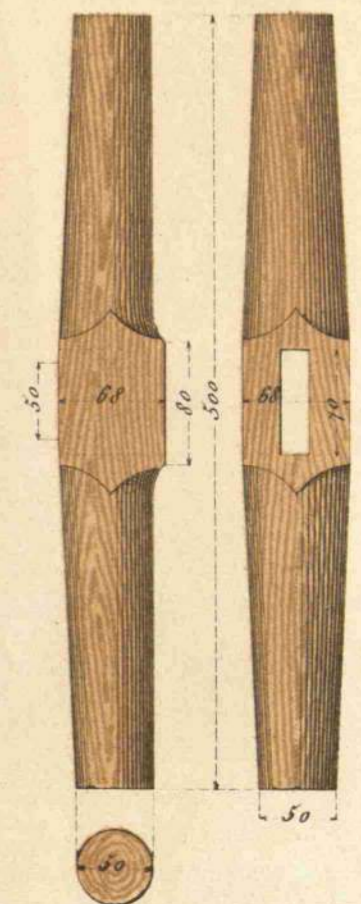



# MATERIAL DE PLAZA COSTA Y SITIO. JUEGOS DE ARMAS.

Cebetera para espoletas de proyectiles de 14 y 15 cm.

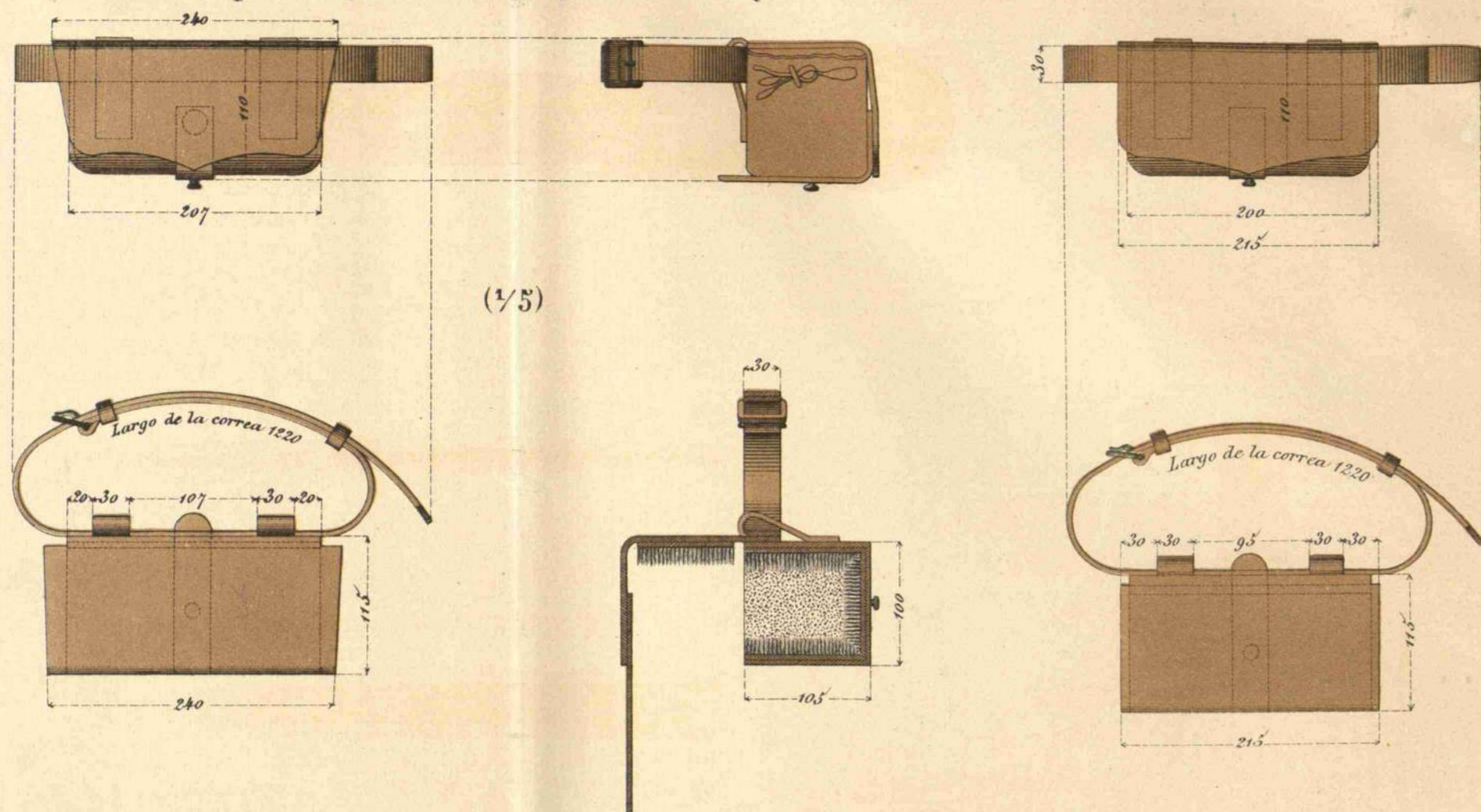

Destornillador para el cierre de cuña del C. Br. 14 cm. (2/5)

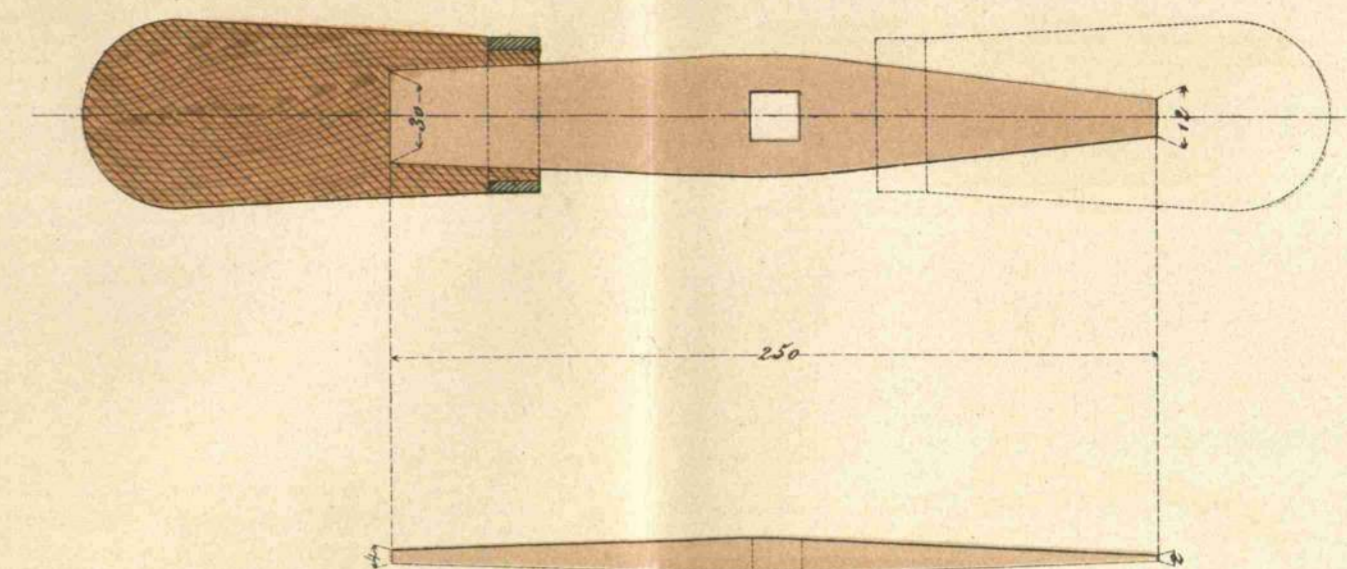

Cacerina (1/5).

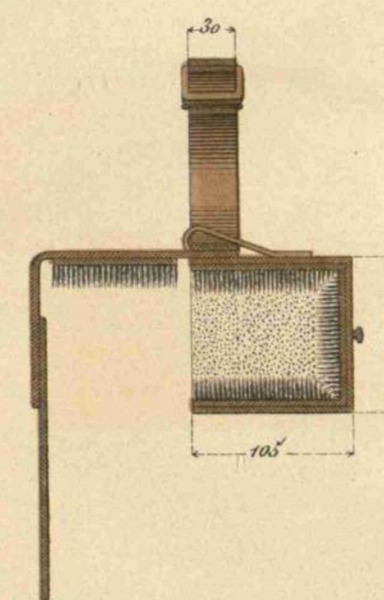

Llave para el cierre de tornillo del C. Br 14 cm. (2/5)

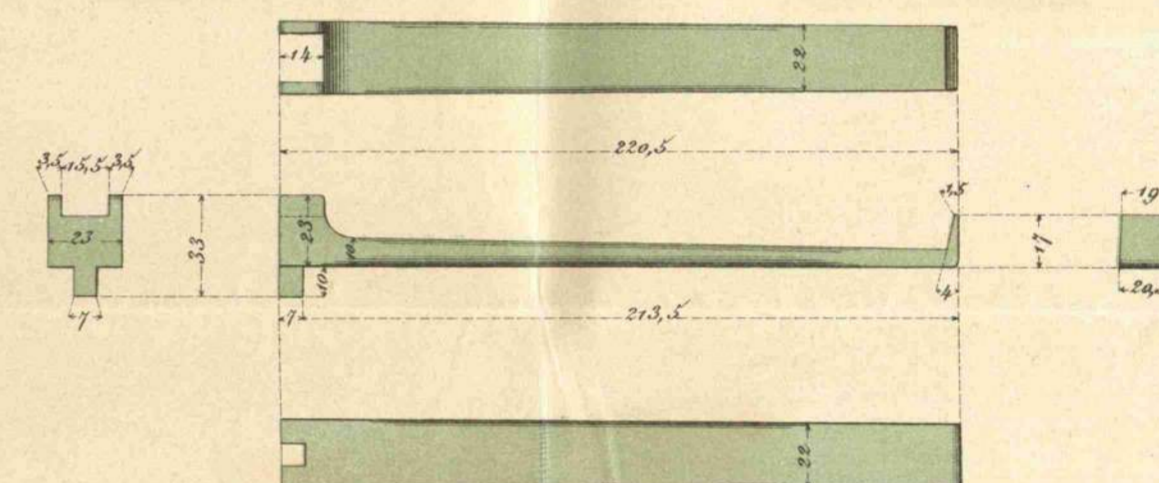

Cubo para agua  
y  
lubrificante.  
(1/5).

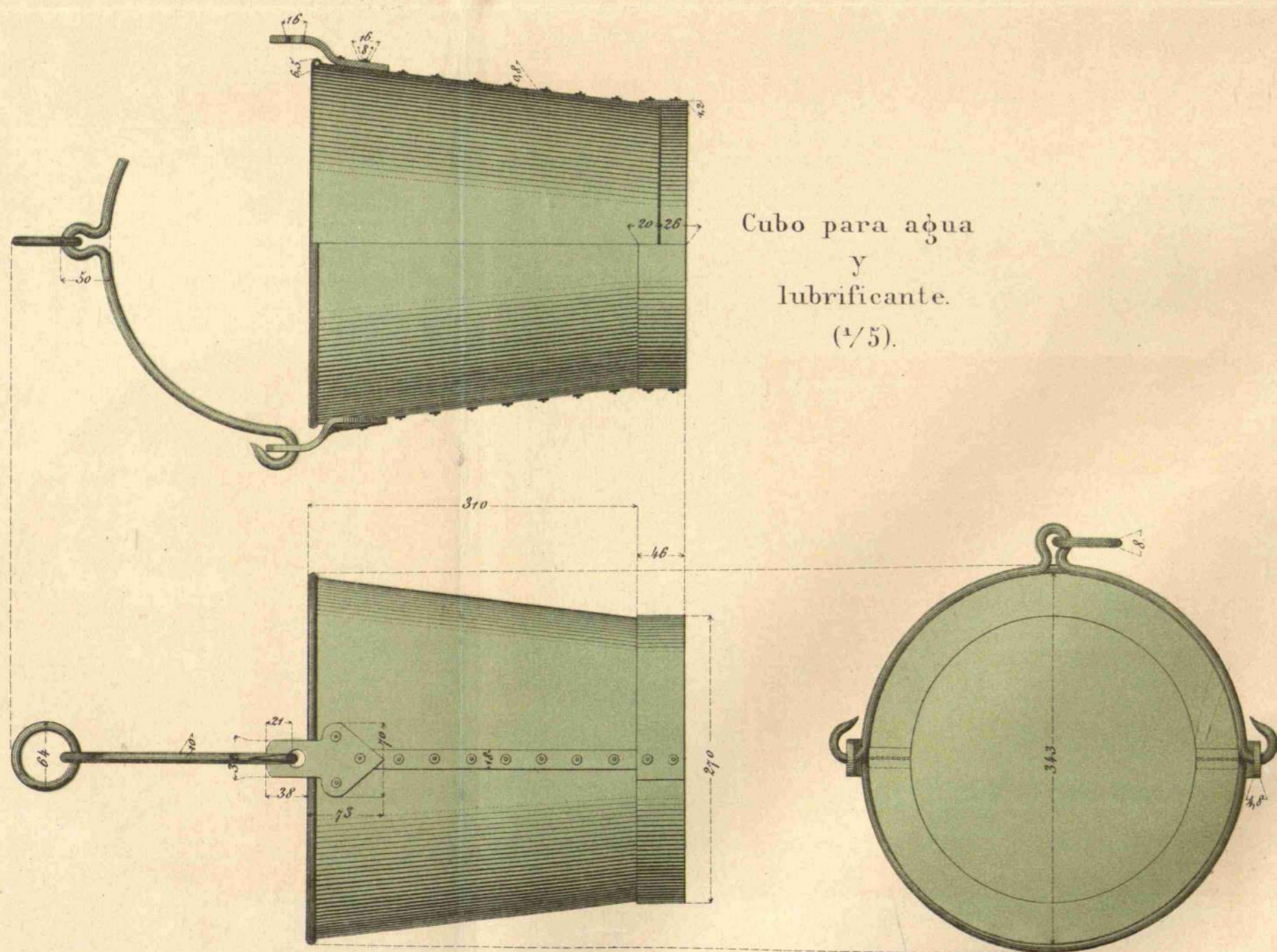

Tina de combate para baterías de Plaza Costa y Sitio. (1/10)

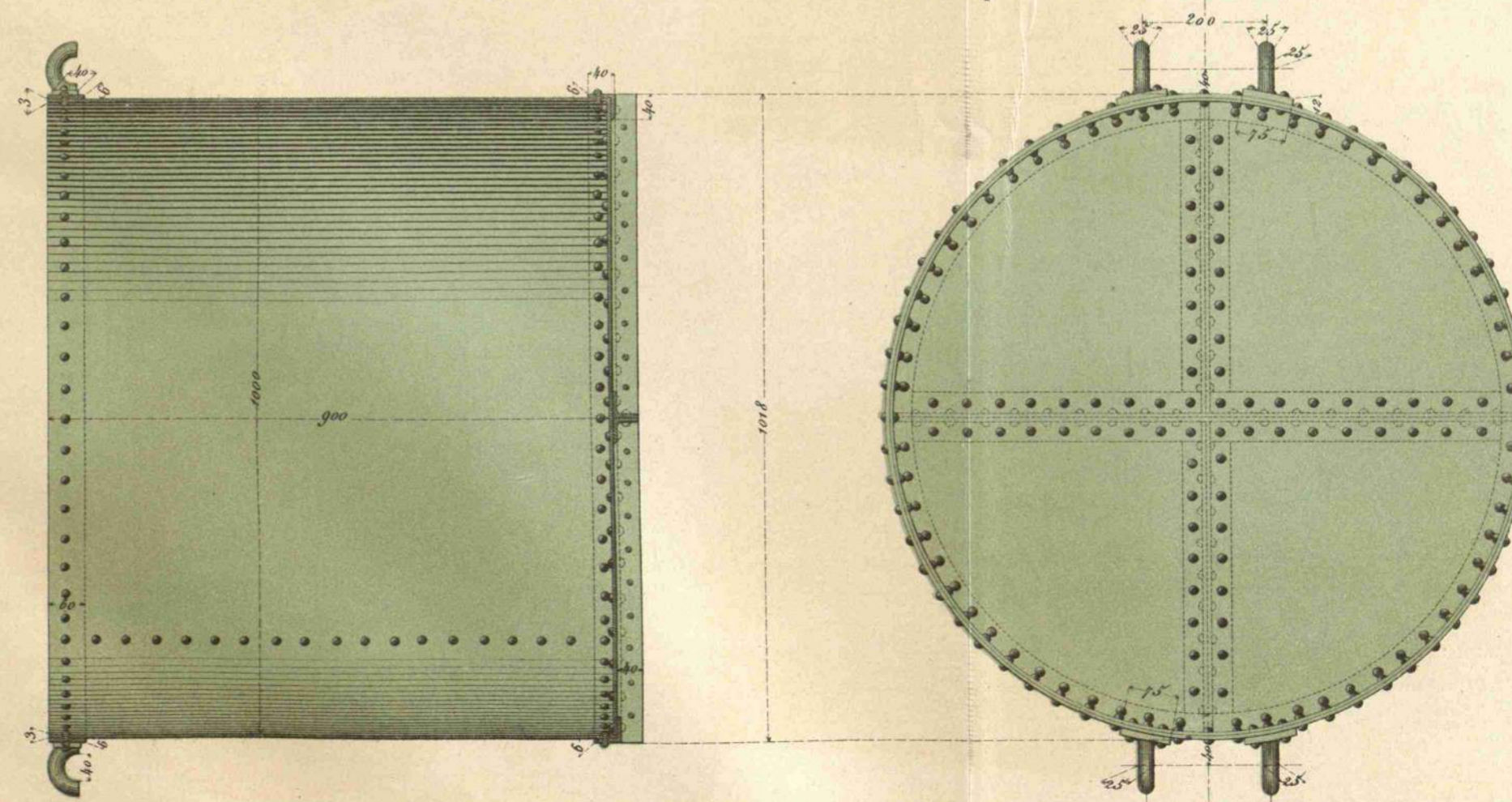



# MATERIAL DE BATALLA.

Pinzote portarueda del material Md. 1868 Rf. 1880 modificado para colocar la rueda de la cureña de chapa 8 cm. (1/5)

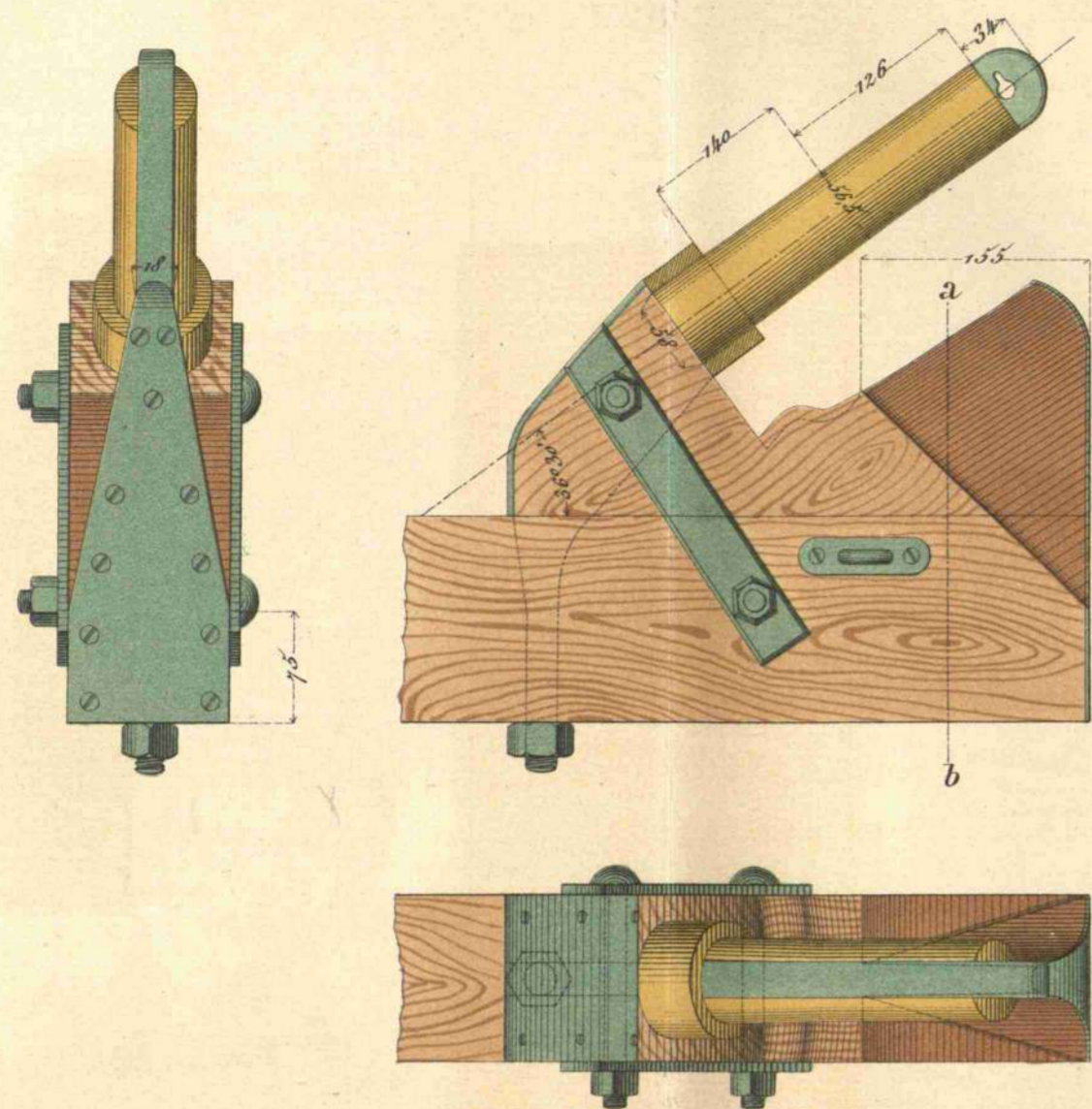

Reformas de las cajas de cartuchos del Material Md. 1868 Rf. 1880 para C. B.e. 8. C.e. (1/5)

Caja anterior del armon.

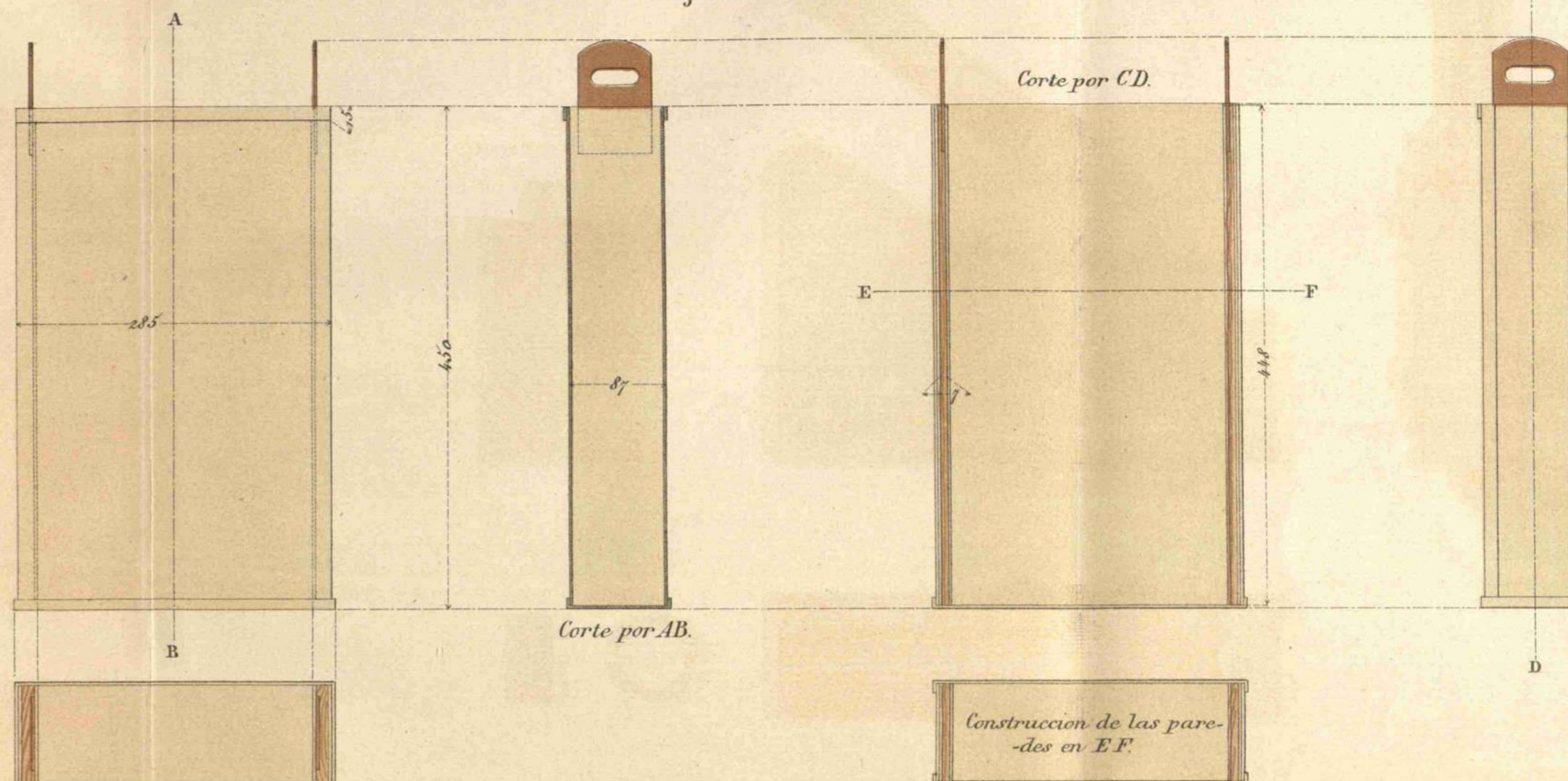

Almohadon de cureña para C. de 8 cm. (1/5)

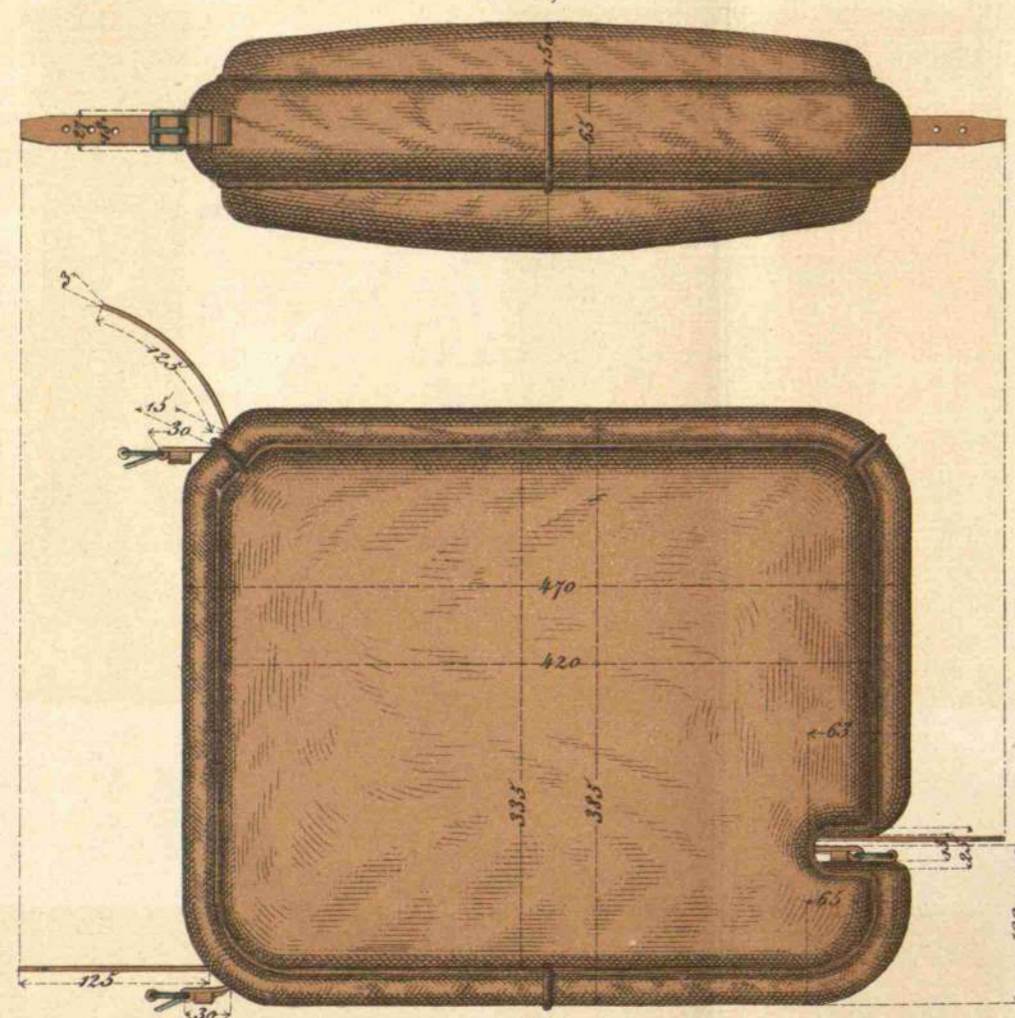

Vista interior.

Caja del carro.

Vista exterior.

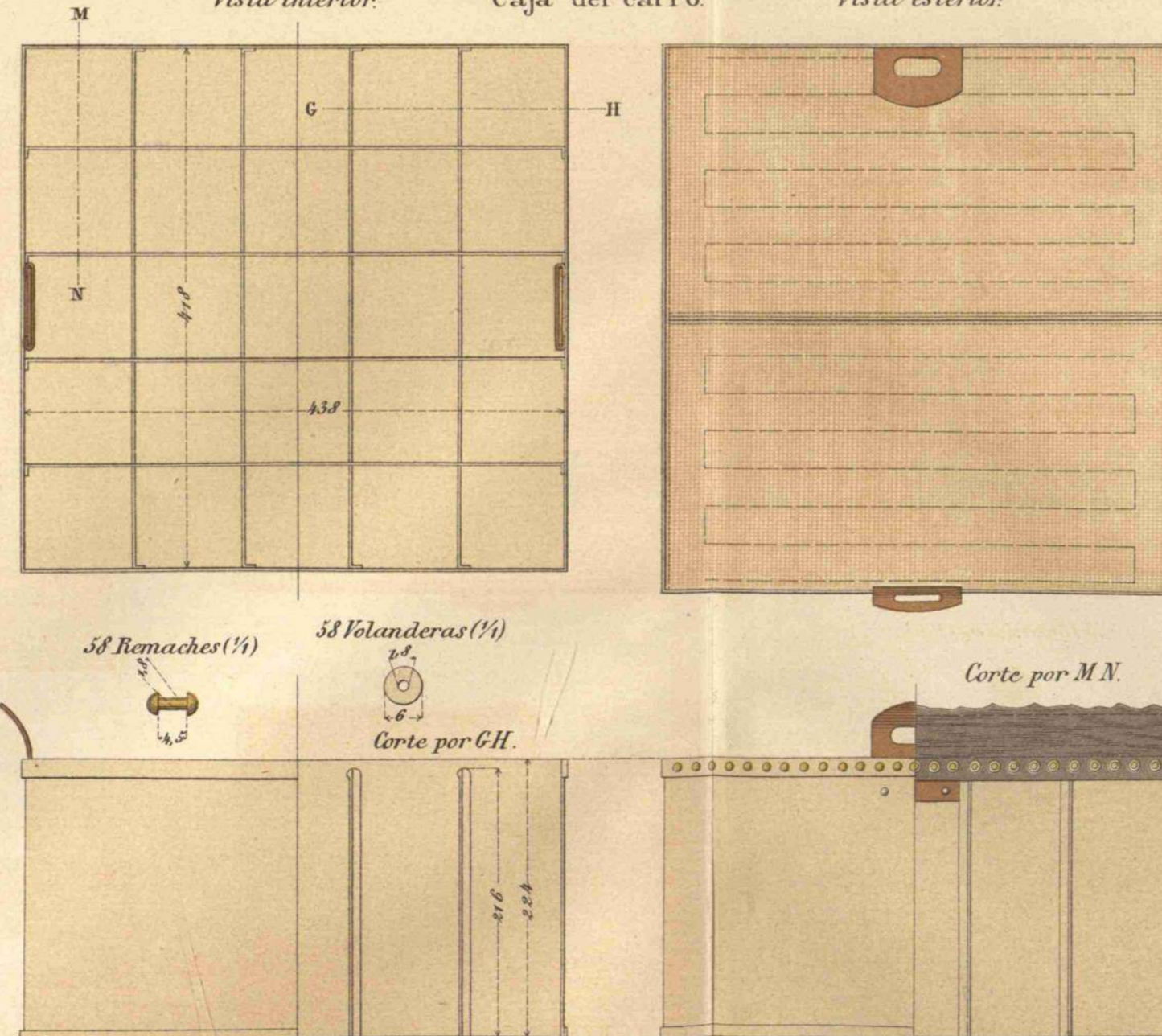

Caja posterior del armon.

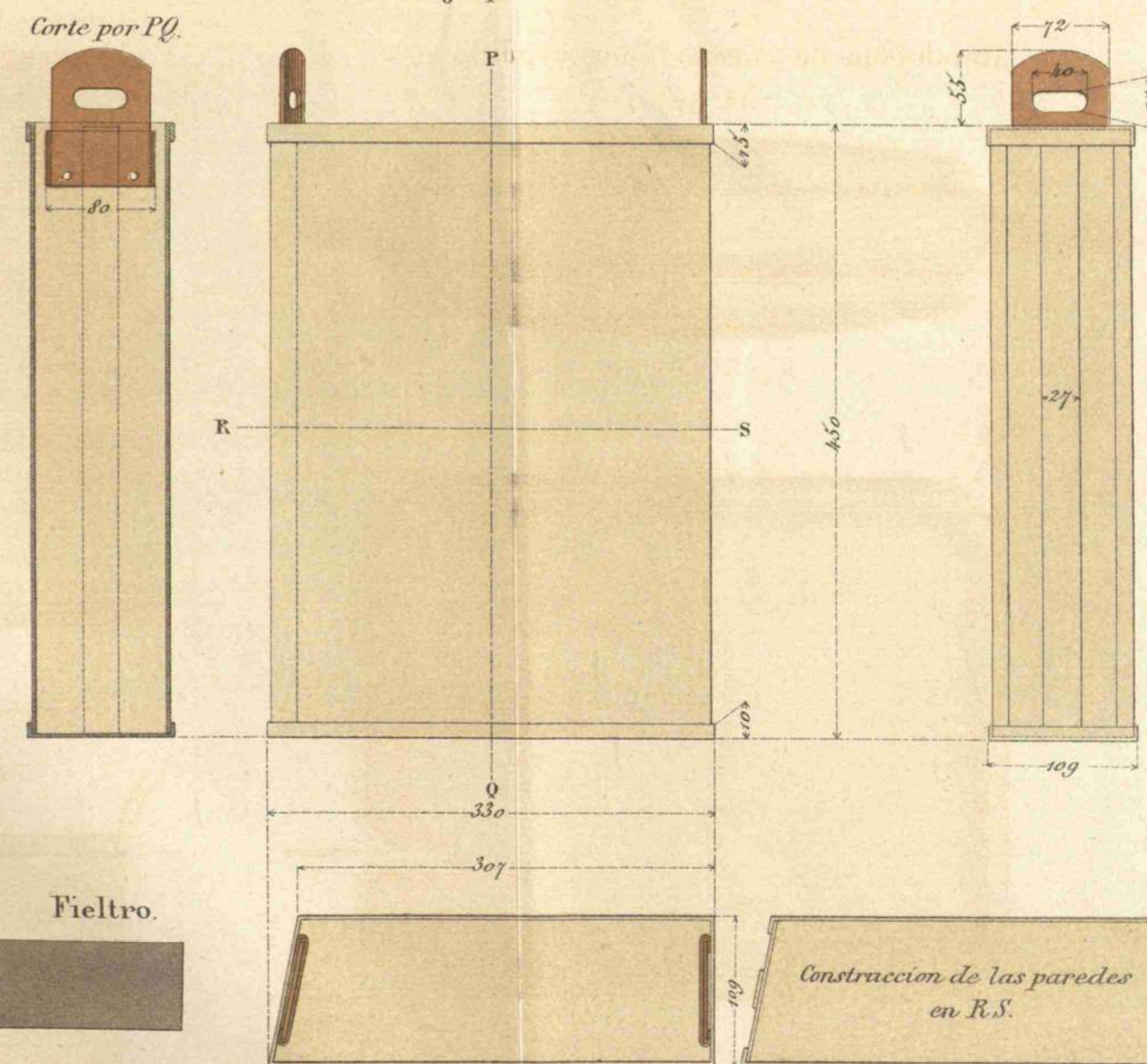



# MATERIAL DE BATALLA.

CUREÑA DE CHAPA MD. 1880 PARA C. Ac. RF. Y Bo. 8 Co.

Escala 1/10.

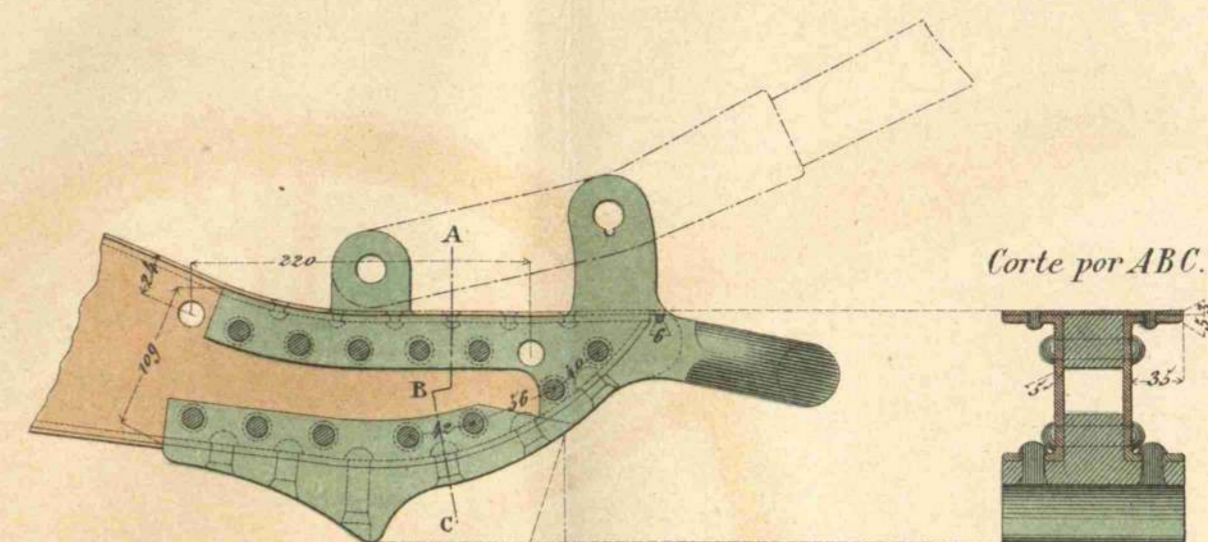
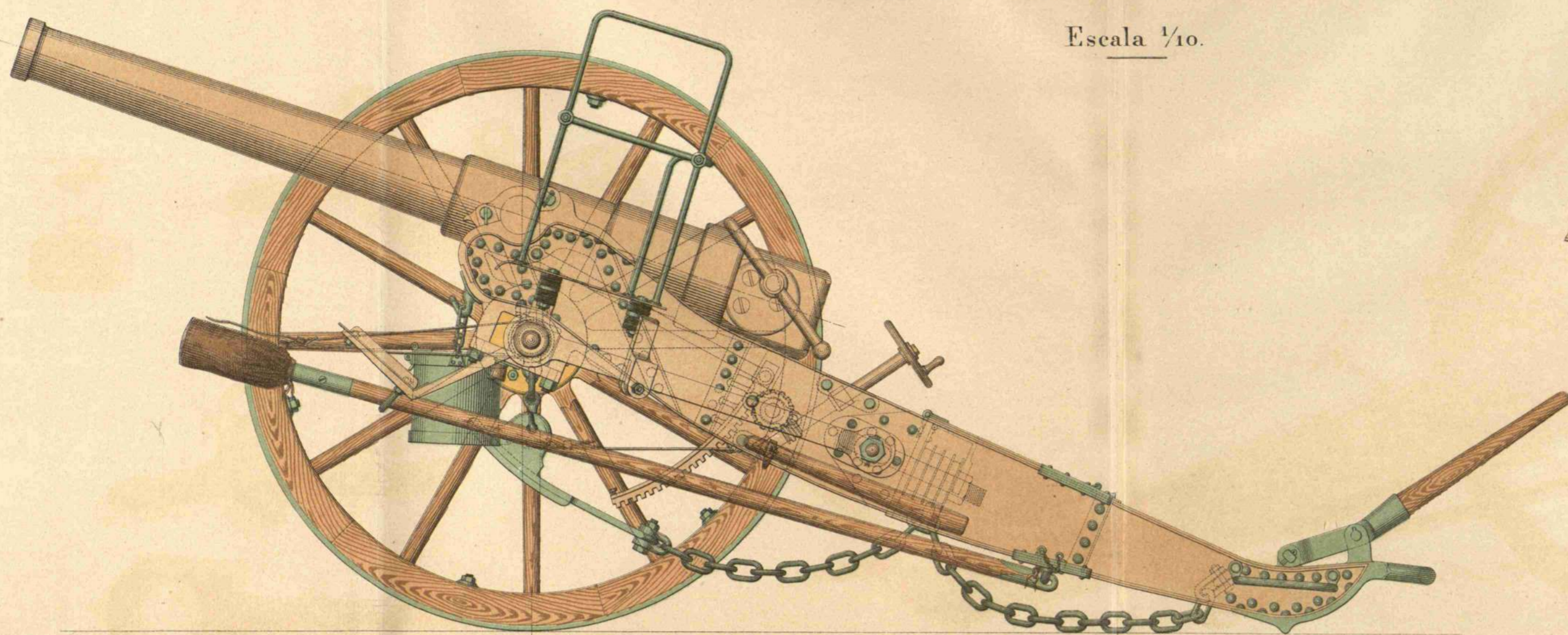

Argollon de contera (1/5)

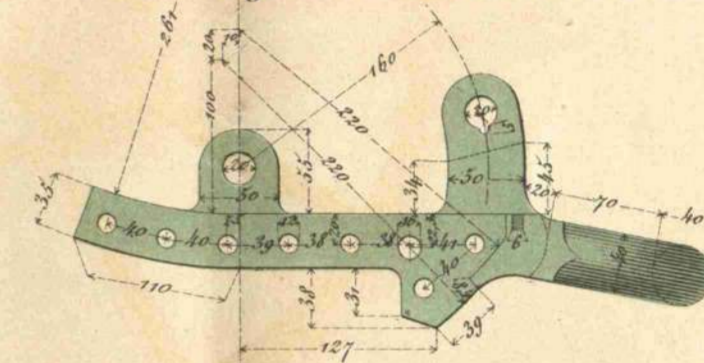

Rozadera arado. (1/5)

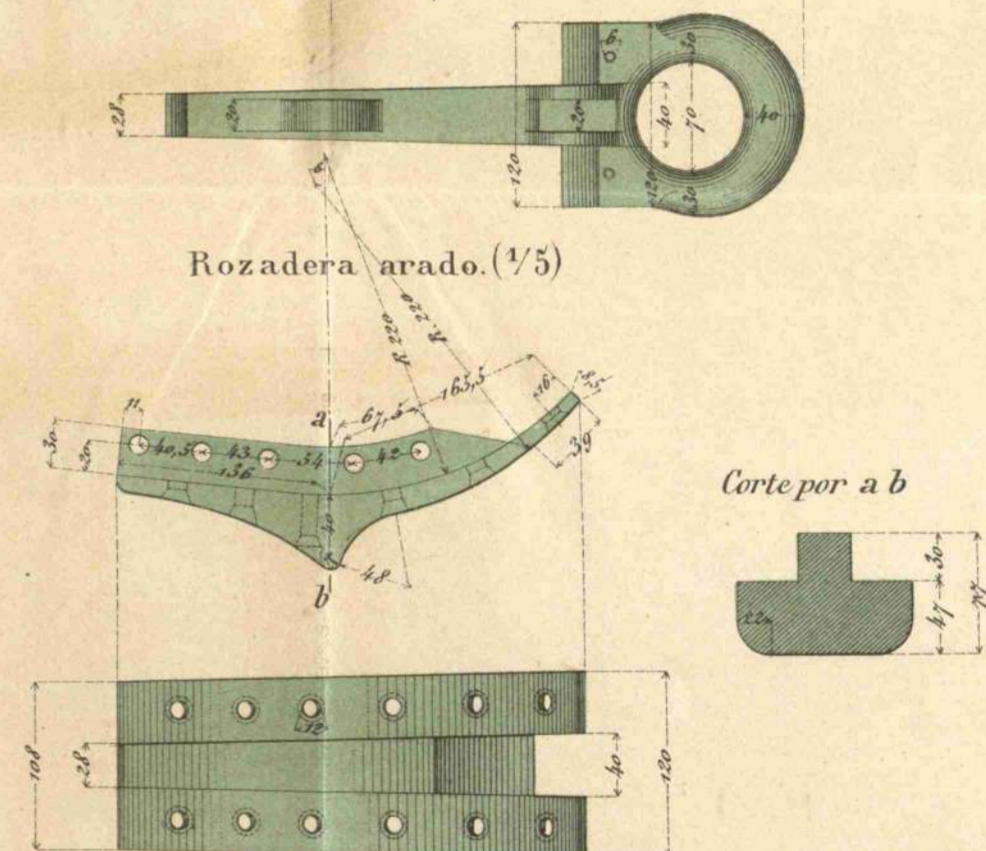

Palanca de direccion (1/5)

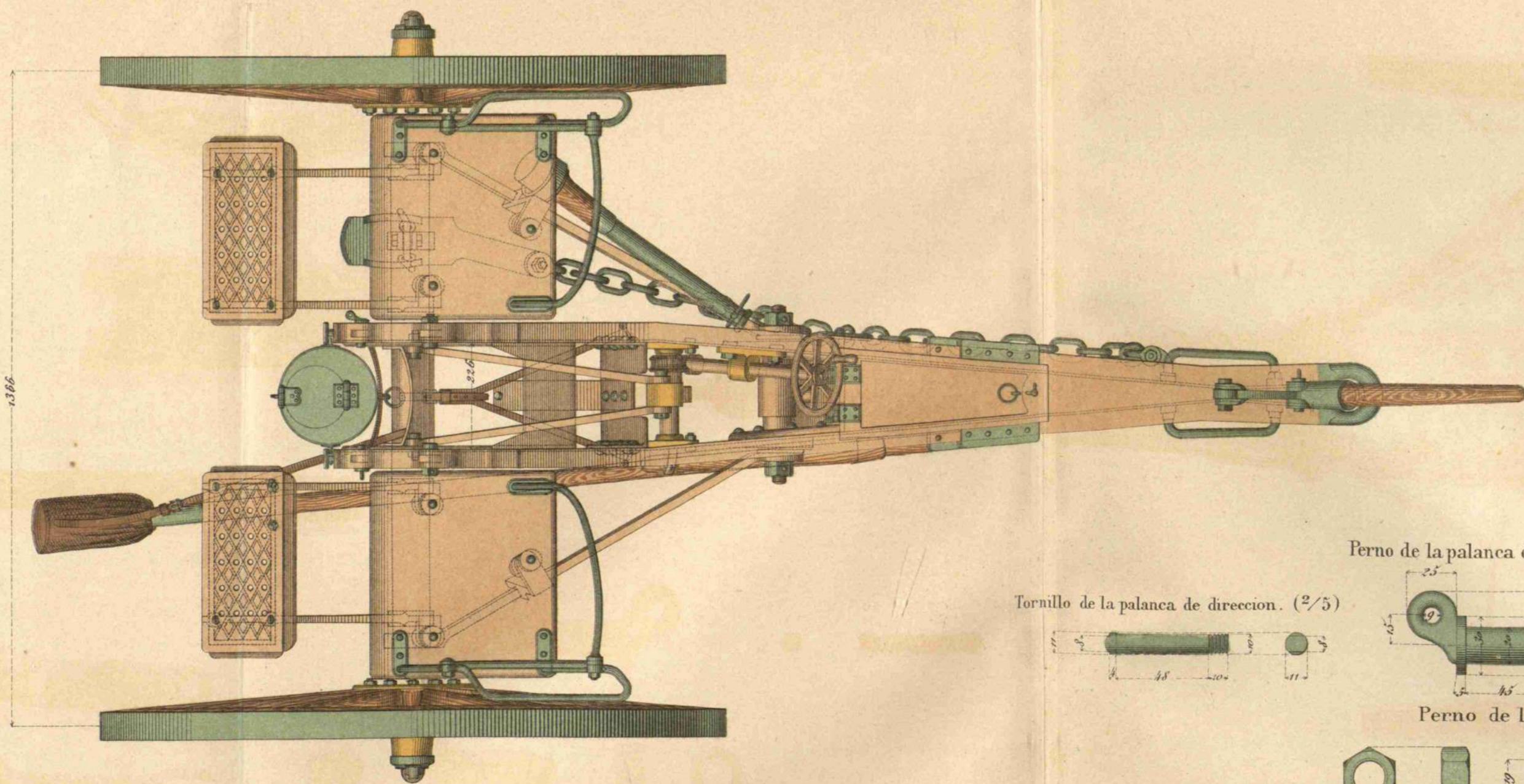

Corte por c d.

Perno de la palanca de direccion (2/5)

Tornillo de la palanca de direccion. (2/5)

Perno de la porta palanca (2/5)

Porta palanca de direccion (1/5)



### MATERIAL DE BATALLA. CUREÑA DE CHAPA MD. 1880 PARA C. Ac. RF. Y B. Co. S. Co. DETALLES. Escala 1/5.

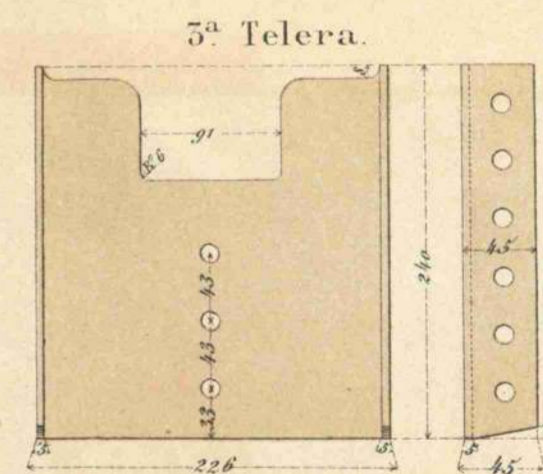
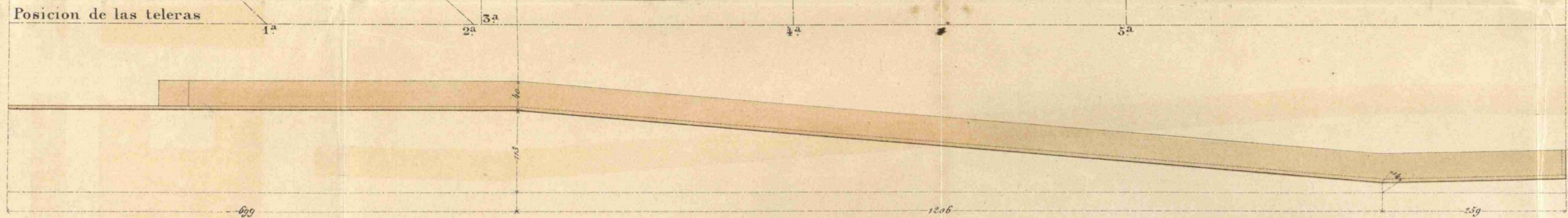
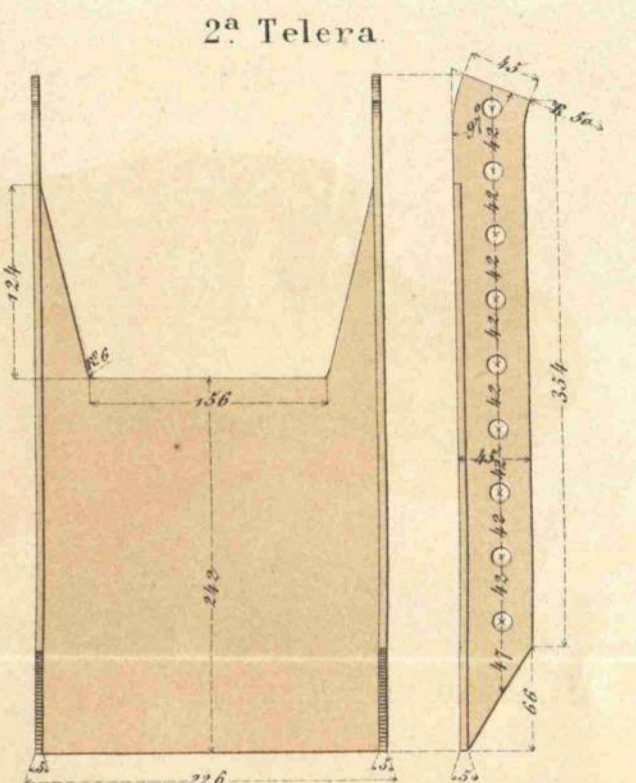
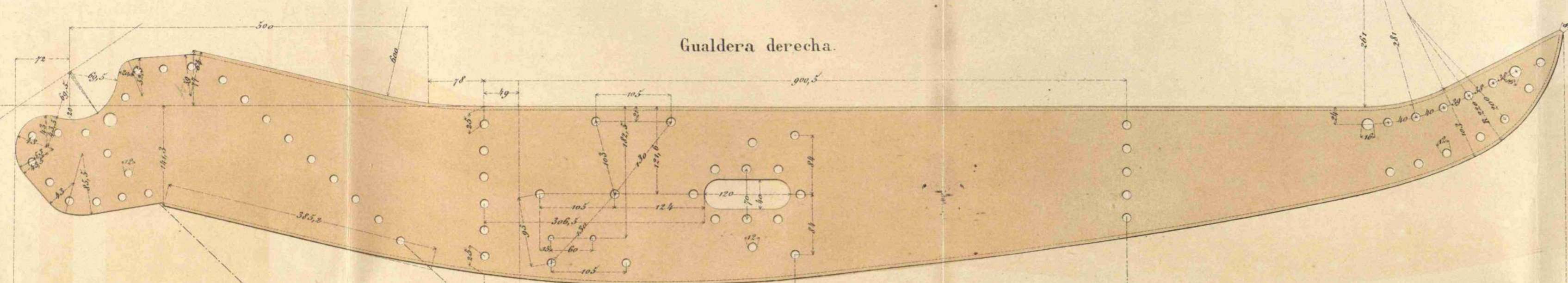
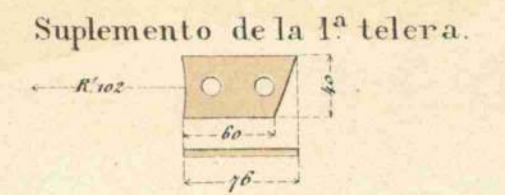
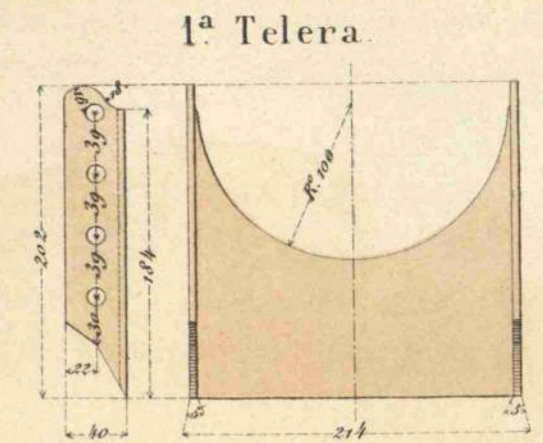
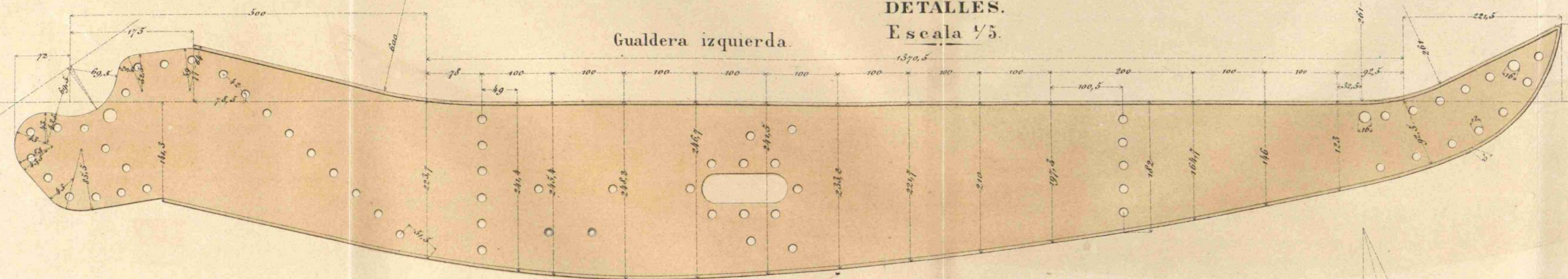

Refuerzos de la cabeza de la gualdera.

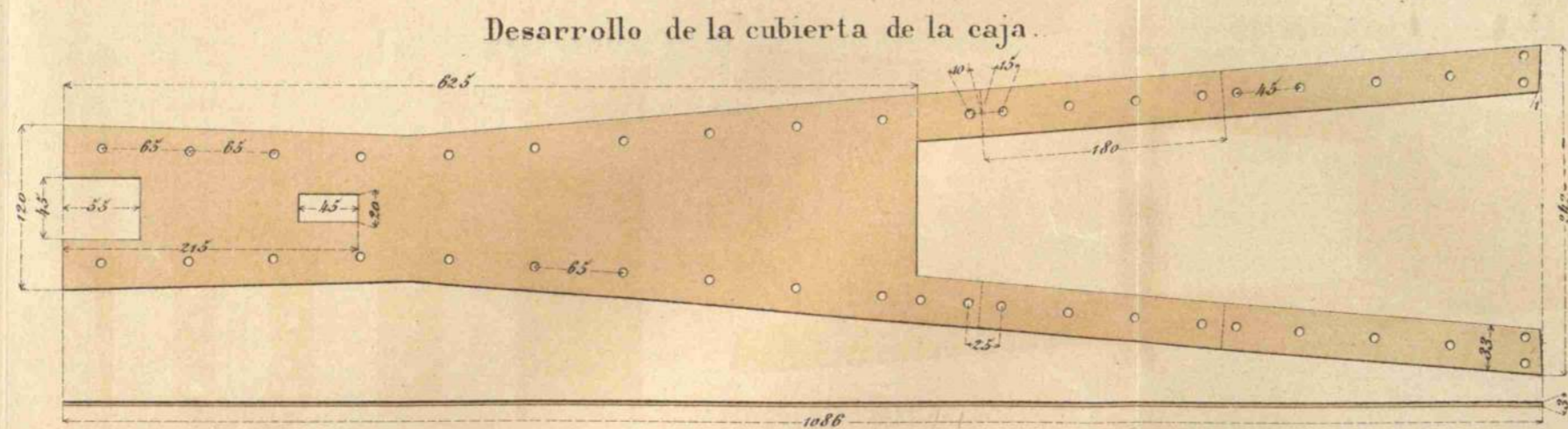
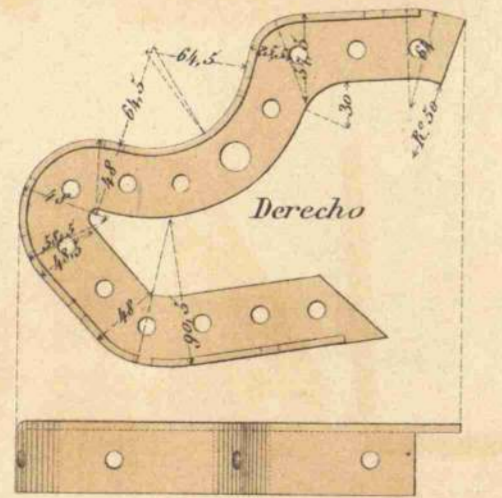

5ª Telera.

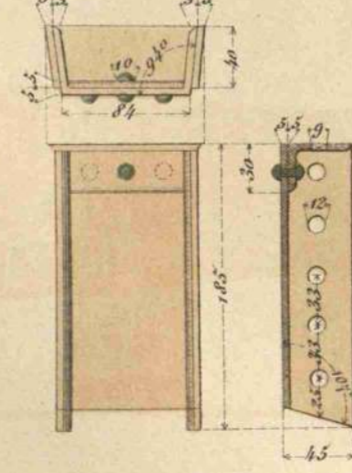

Reinuerzo de la 4ª Telera. (2)

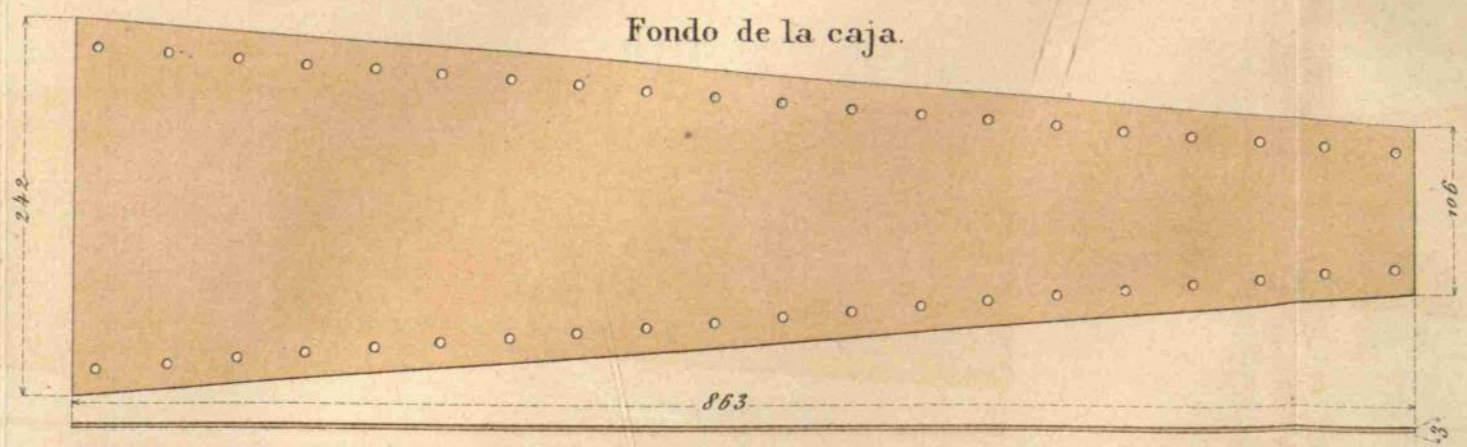
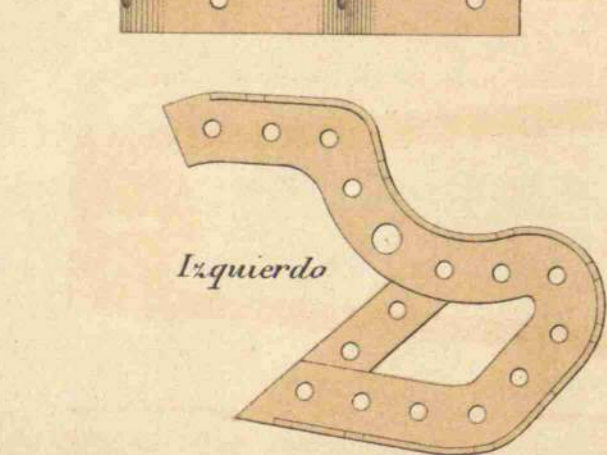
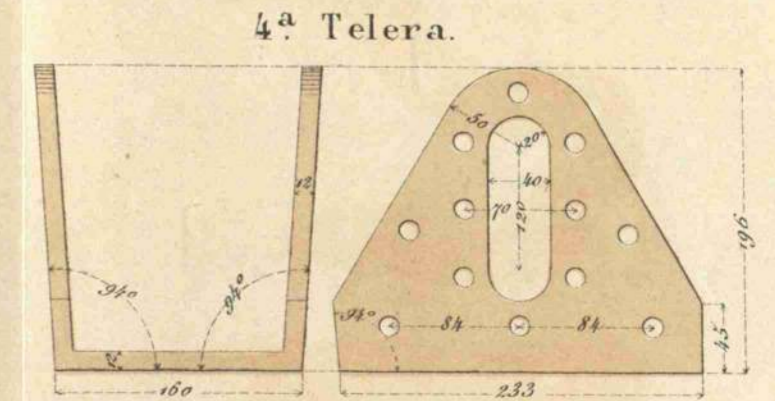
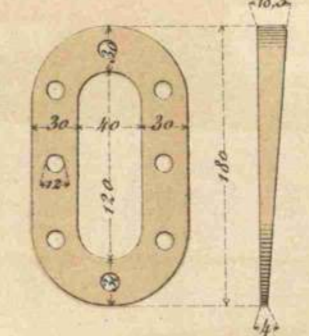

Tapa de la caja.

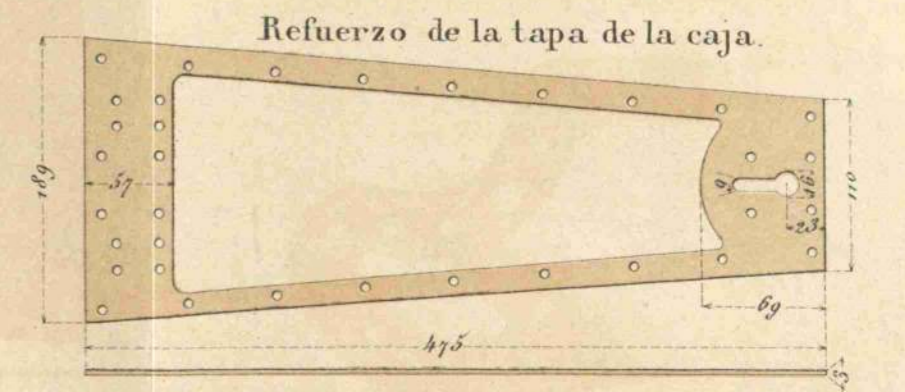
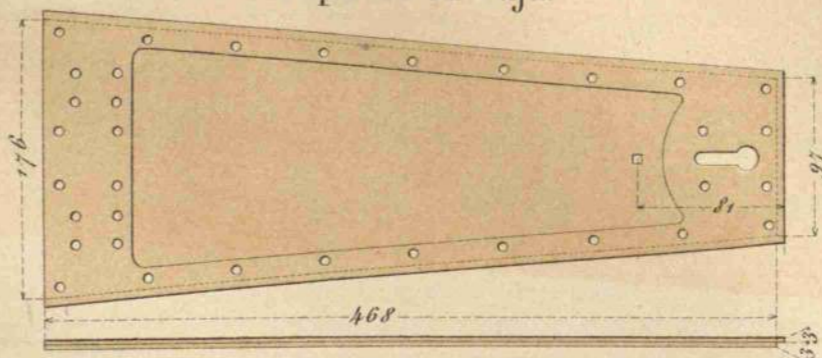



MATERIAL DE BATALLA.  
CUREÑA DE CHAPA MD. 1880 PARA C. Ac. RF. Y Bc. 8. Co.  
DETALLES.  
Escala 2/5.

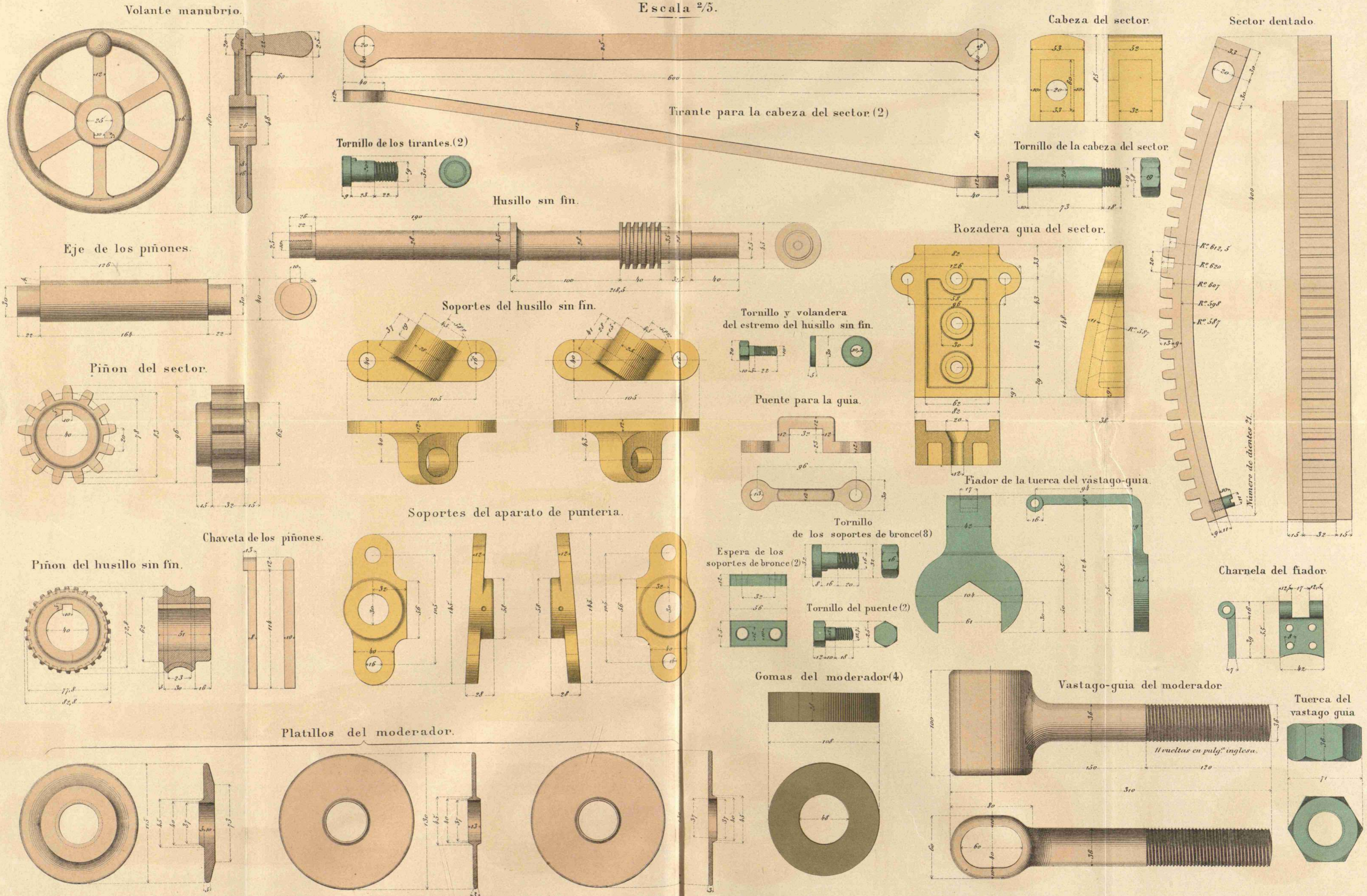



# MATERIAL DE BATALLA.

## CUREÑA DE CHAPA MD. 1880 PARA C. Ac. RF. Y Bc. 8. Co.

### DETALLES.

Muñonera (2) (2/5).

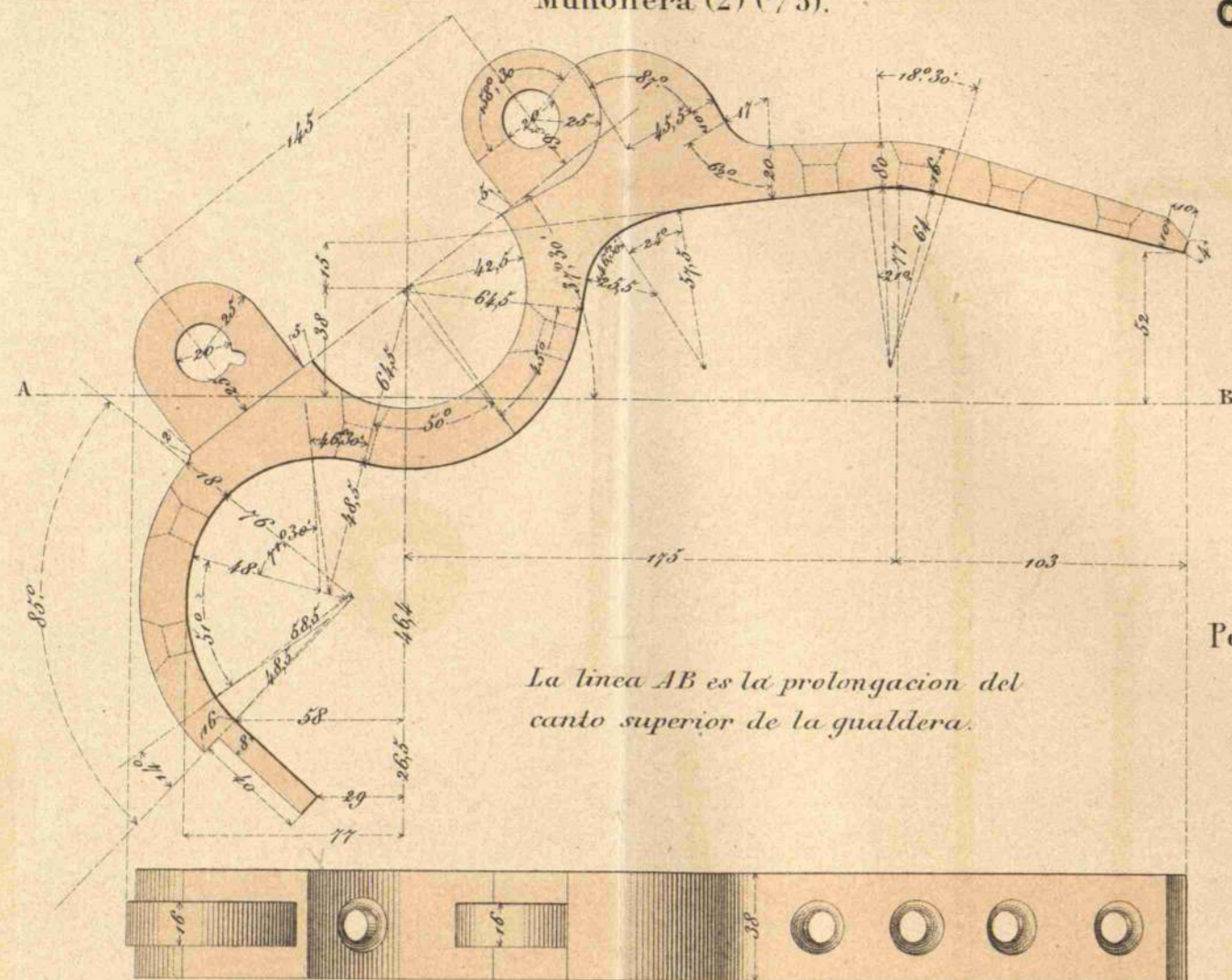

Sobremuñonera (2) (2/5).

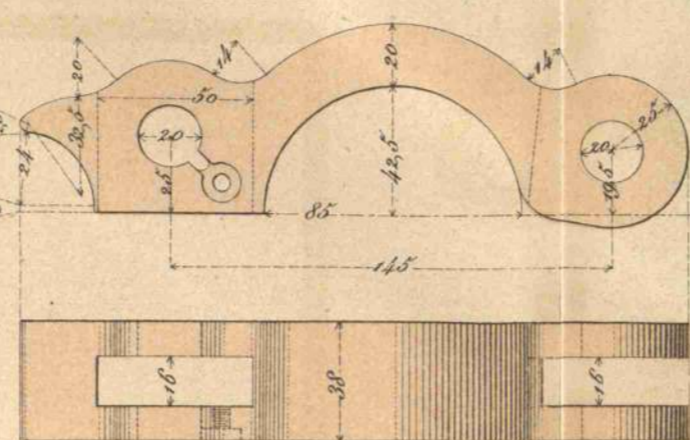

Balconcillo (2) (1/5).

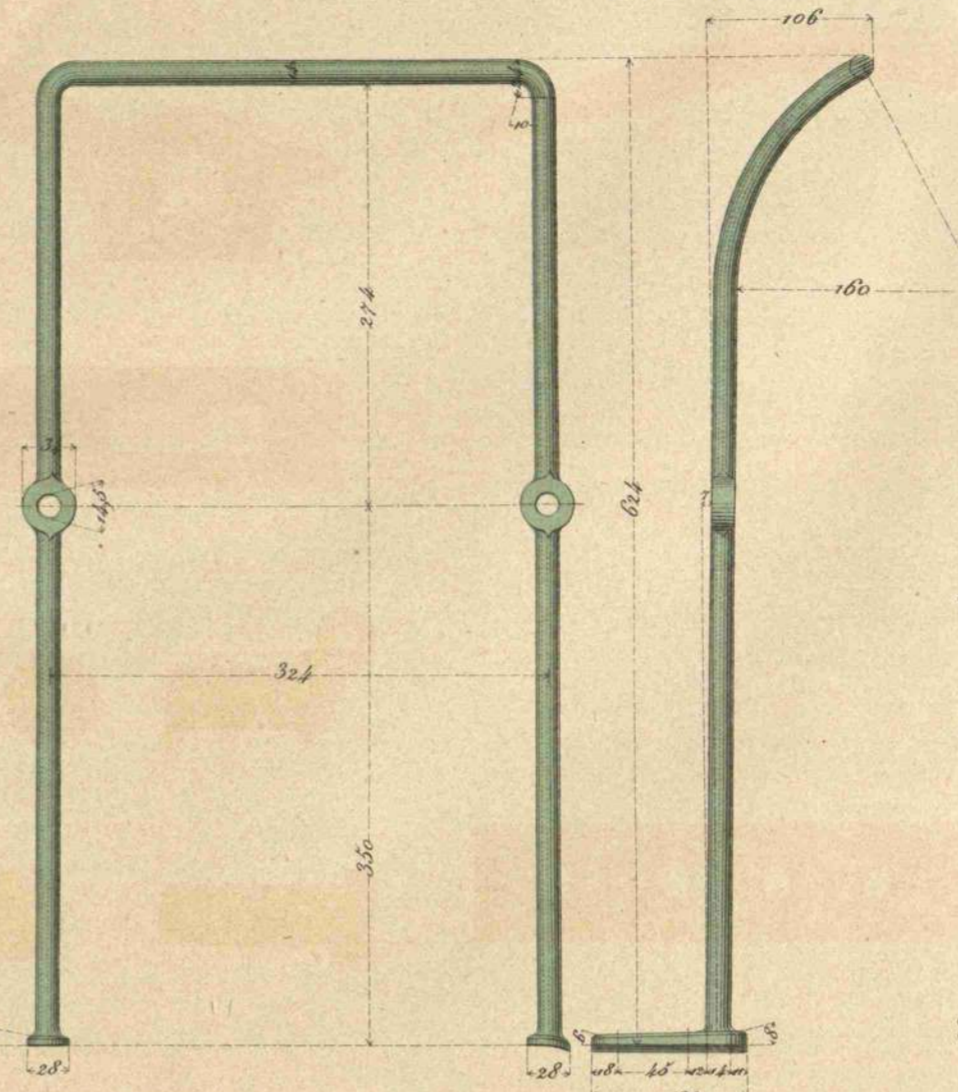

Volanderas del asiento (24)

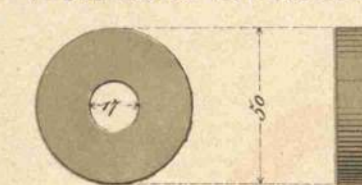

(18)



Perno de la muñonera (2) (2/5)

Tope de retenida (2)

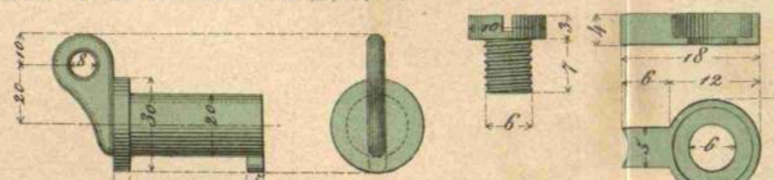

Tornillo de la muñonera (2) (2/5).

(2) (2/5).



Sotabraga (2) (2/5)

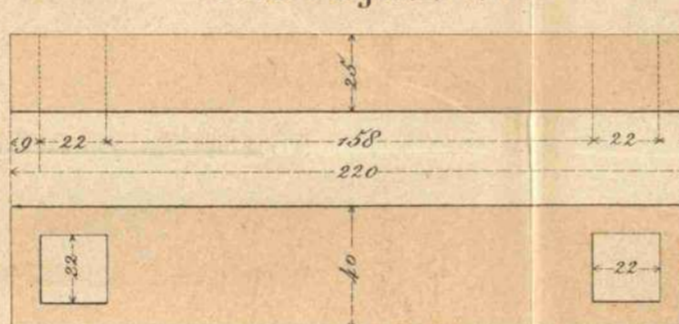

Braga (2) (2/5).

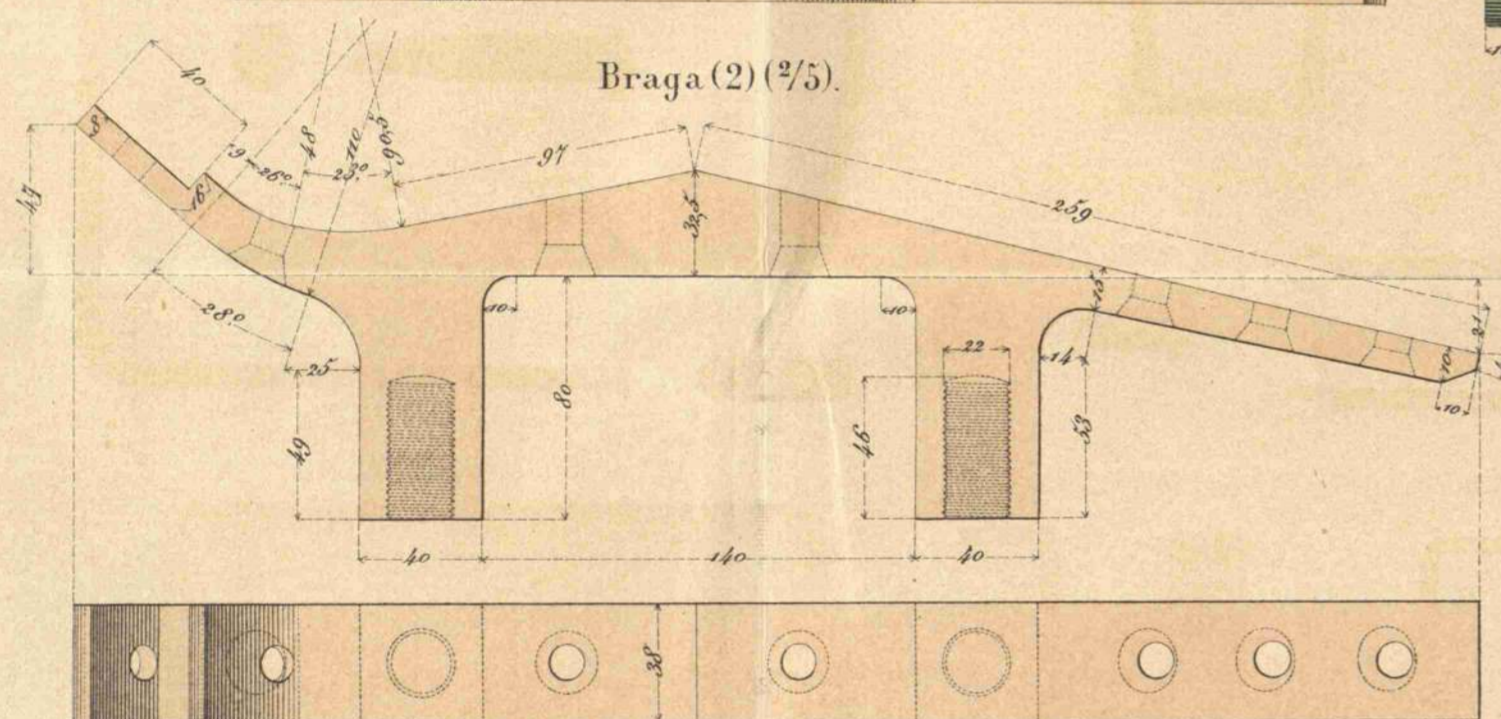

Soportes del asiento y estribo (2) (1/5).

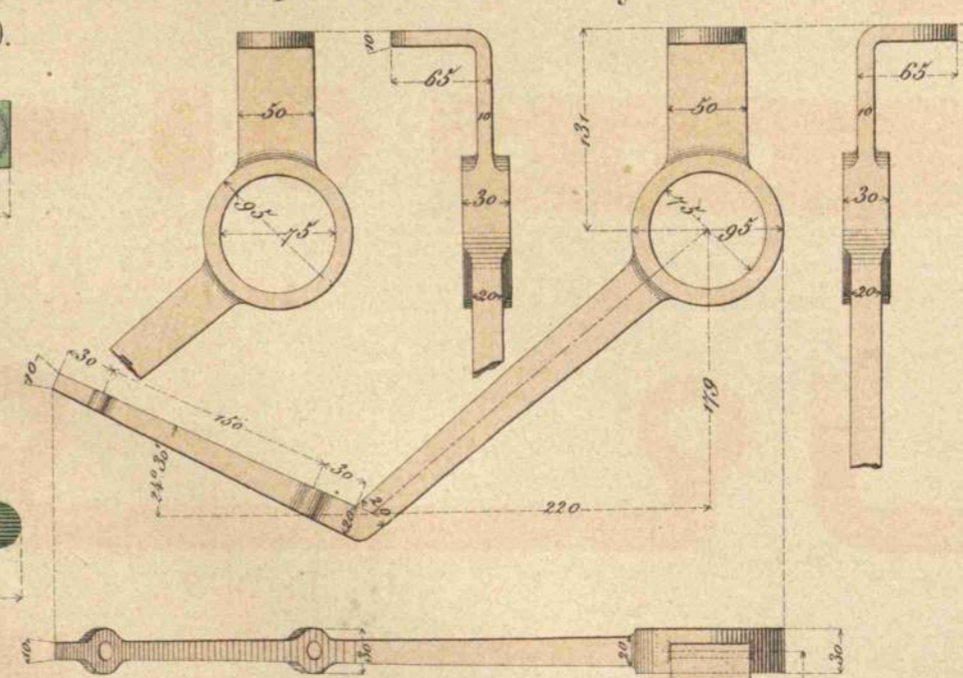

Asiento (2) (1/5).

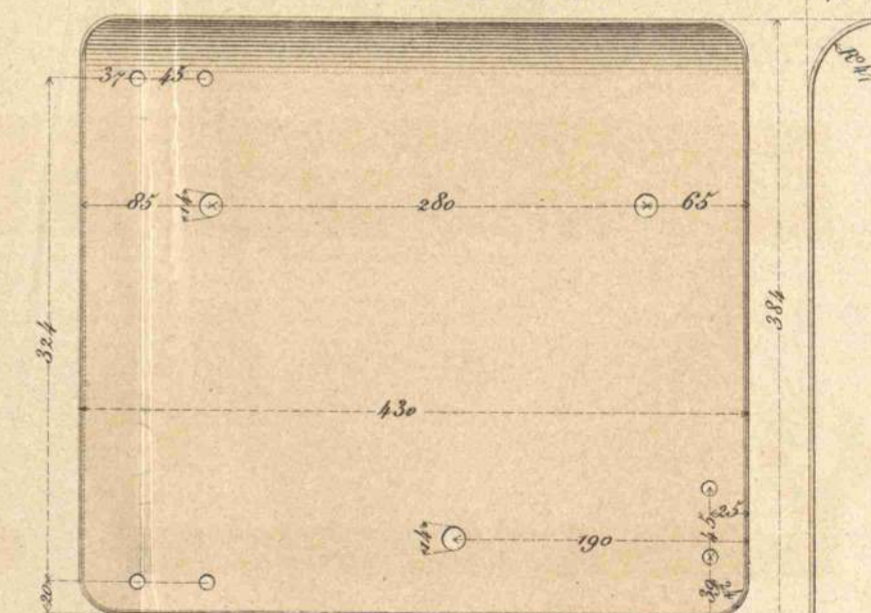

Asas de contera (2/5).

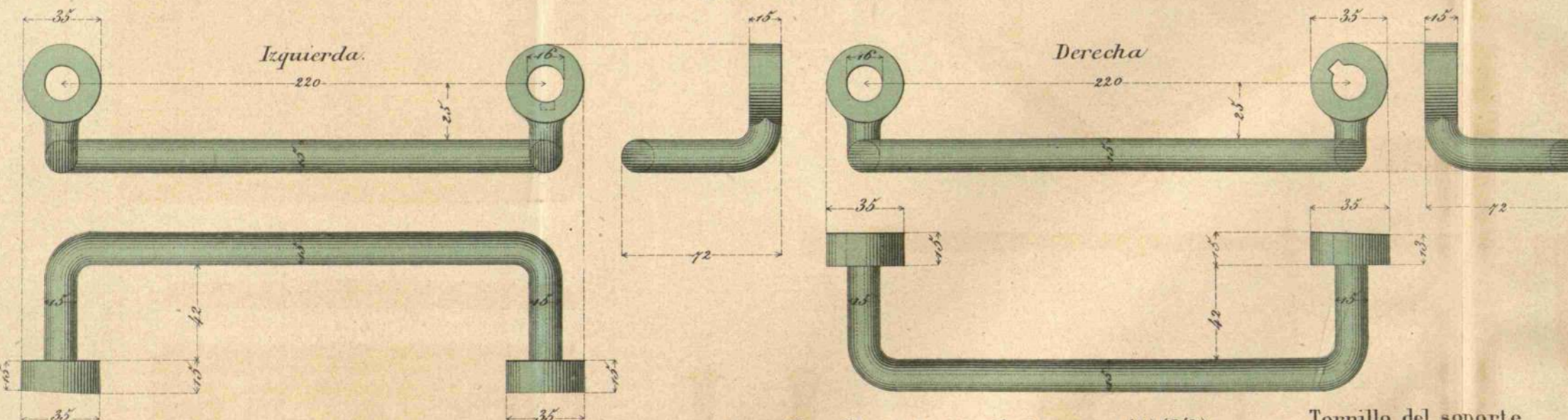

Tornillo posterior de las asas (2/5).

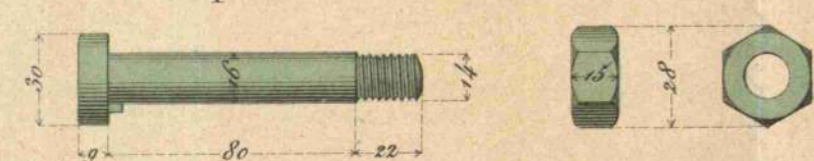

Tornillo anterior de las asas (1) (2/5).

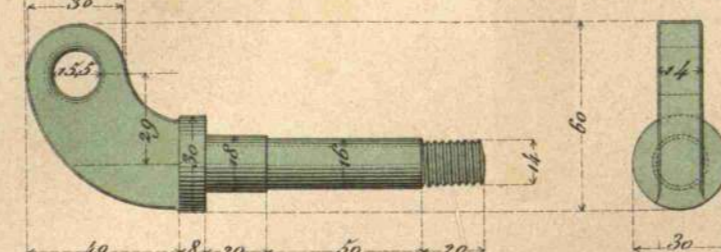

Tornillo del soporte del asiento (2/5).

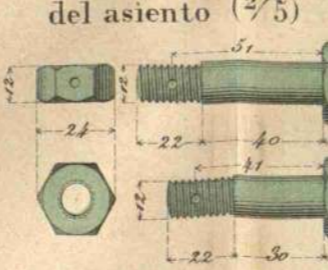

Soporte del asiento (2) (1/5).

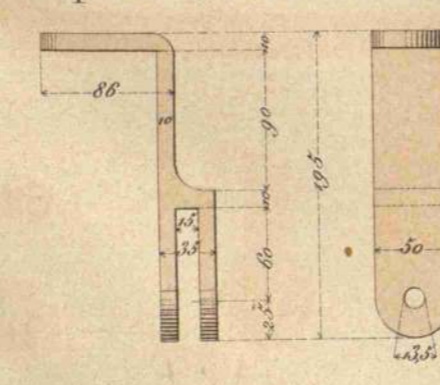

Tornillos de los estribos (3/5).

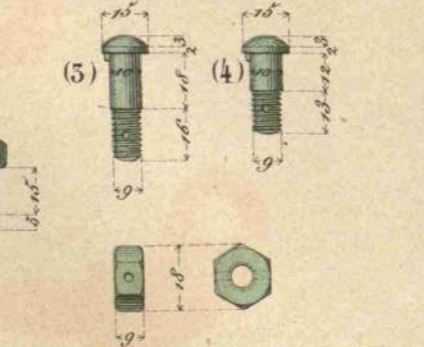

Estribo (2) (1/5).

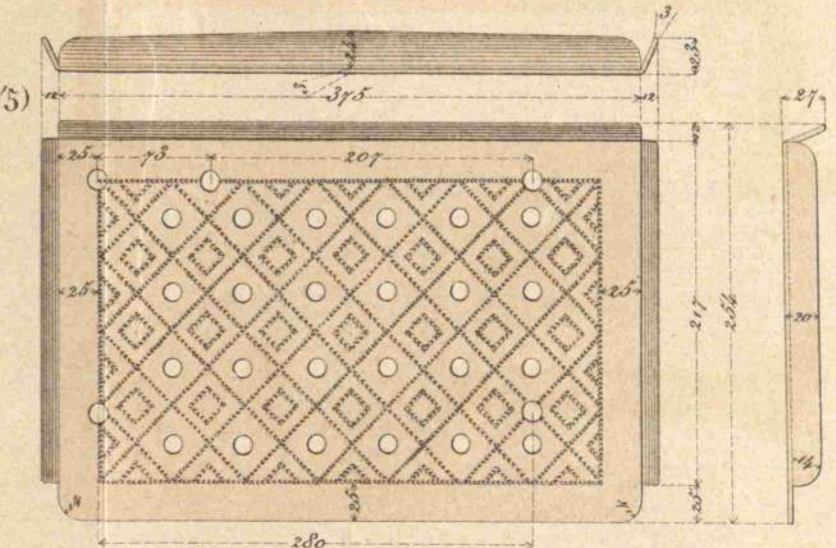



# MATERIAL DE BATAJA.

## CUREÑA DE CHAPA Md. 1880 PARA C. A. C. R. E. Y B. C. Co. S. Co.

### DETALLES.

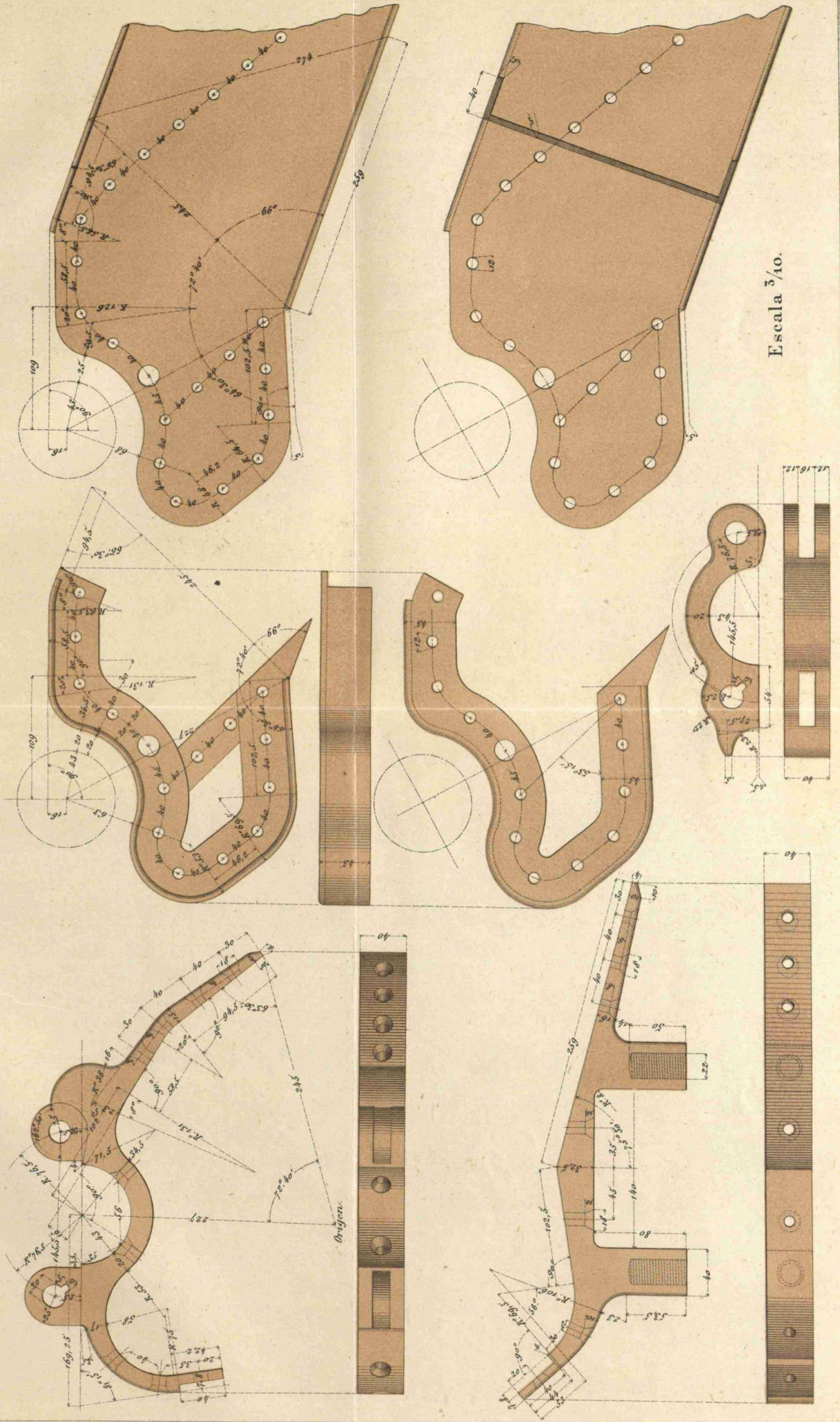



# MATERIAL DE BATALLA.

## CUREÑA DE CHAPA MD.1880 PARA C. Ac. RF. Y Be 8. Co.

### DETALLES.

Rueda (2) (1/10).

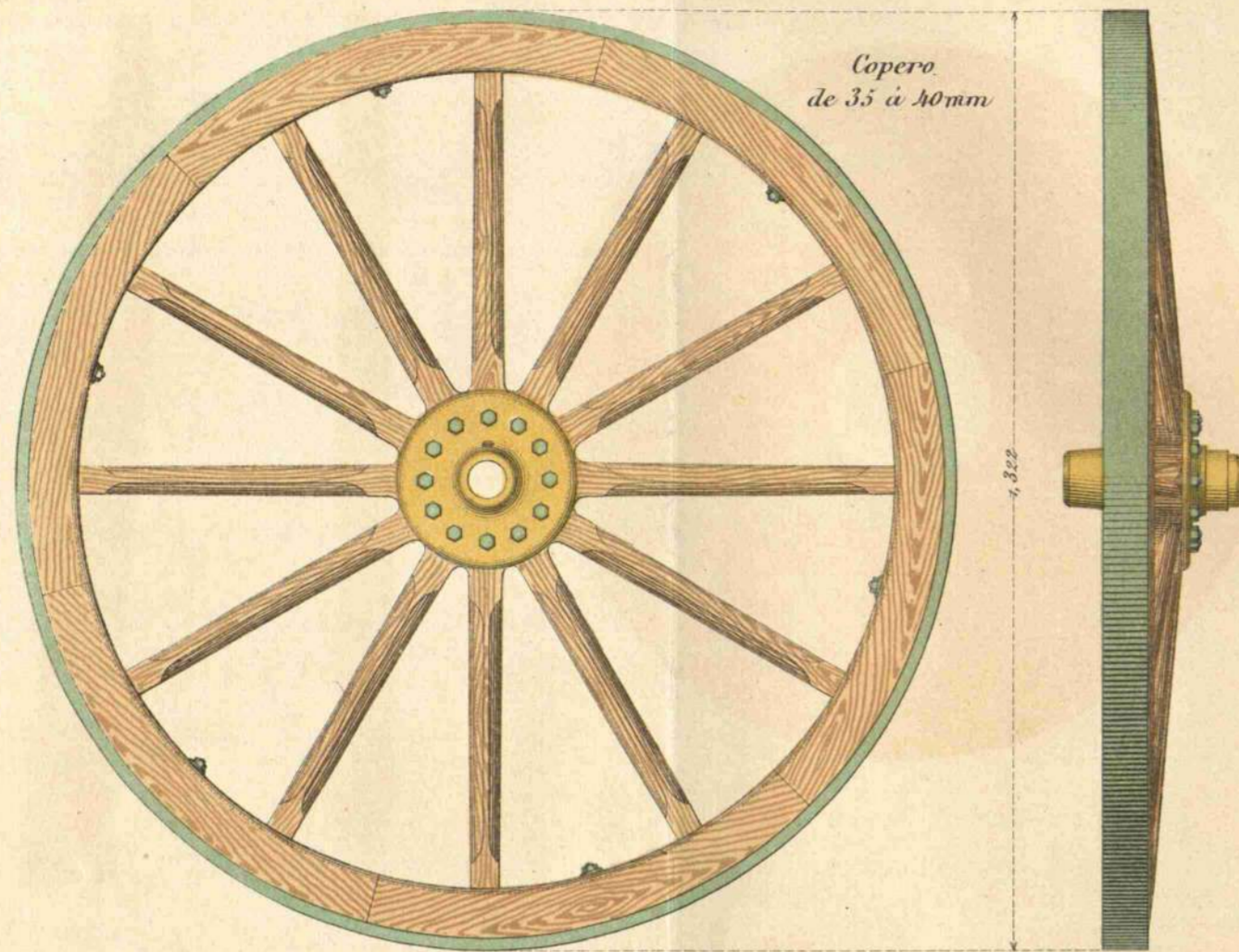

Cubo (2) (2/5).

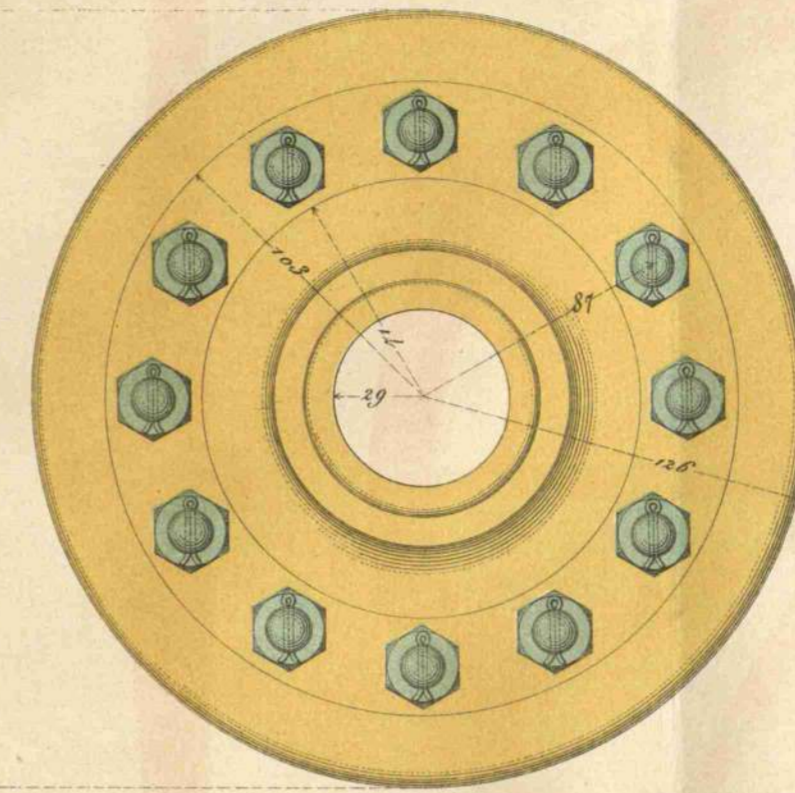
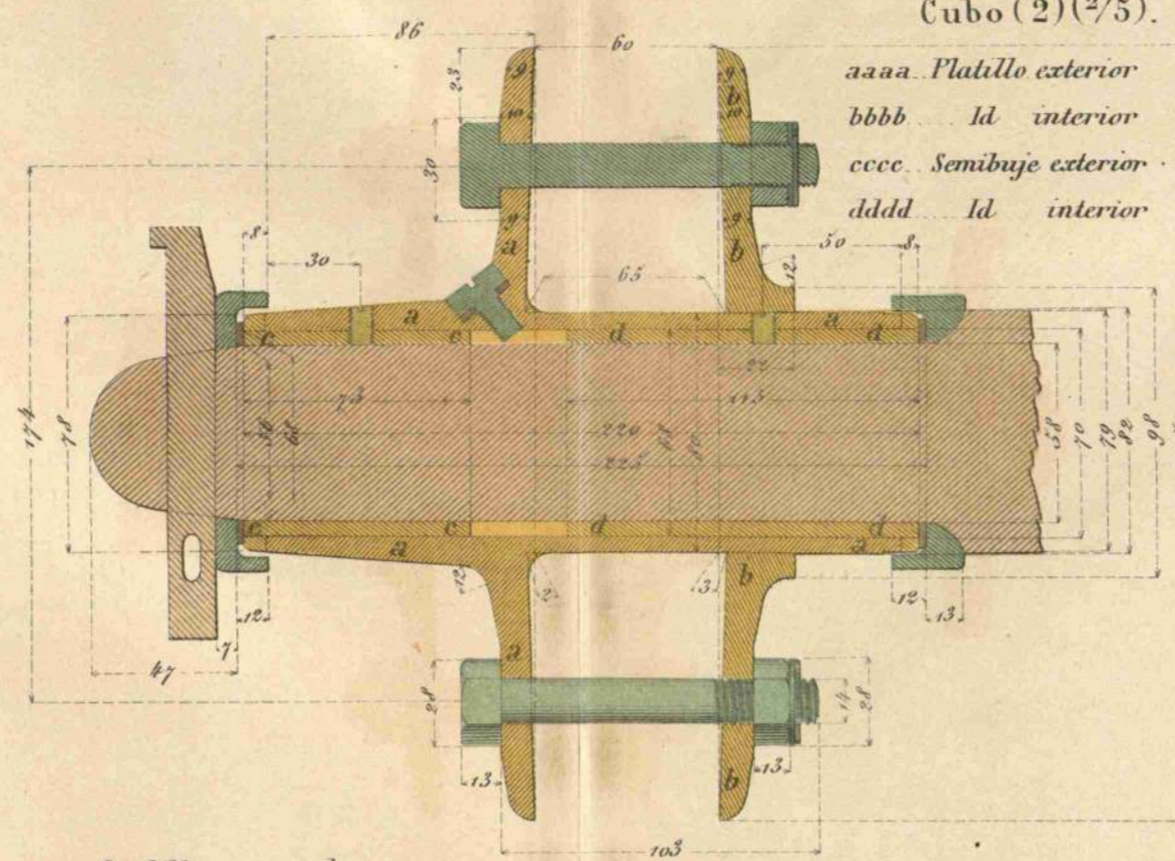

Rayo (12) (1/5).

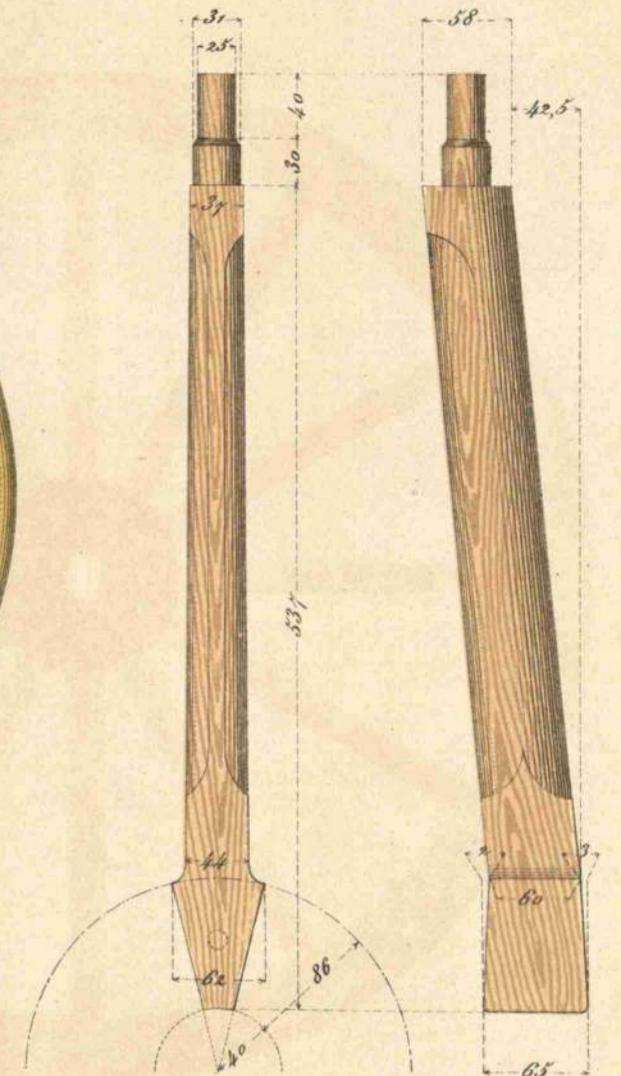

Ovalillo y pasador para los pernos de los platillos (2/5).



Tornillo para el lubricante (2/5).



Zapatilla de euro (2/5).



Perno del aro (6) (2/5).

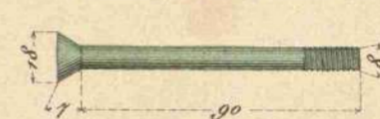

Ovalillo (6) (2/5).

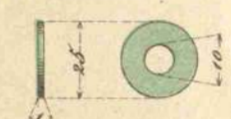

Tornillos de sujecion de los semibujes (2/5).

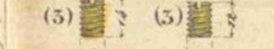

Eje (1/5).

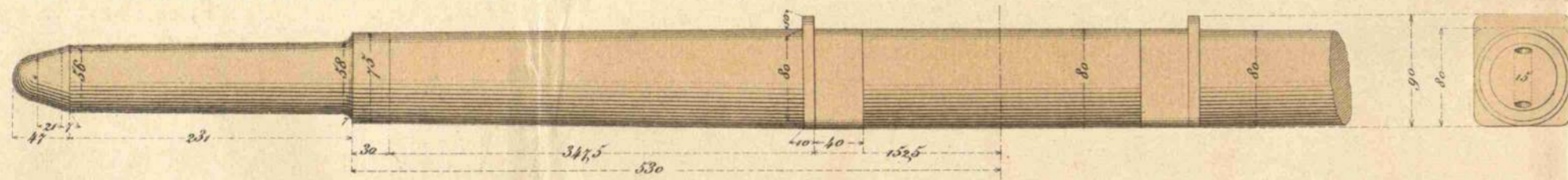

Volandera interior (2) (2/5). Volandera exterior (2) (2/5).

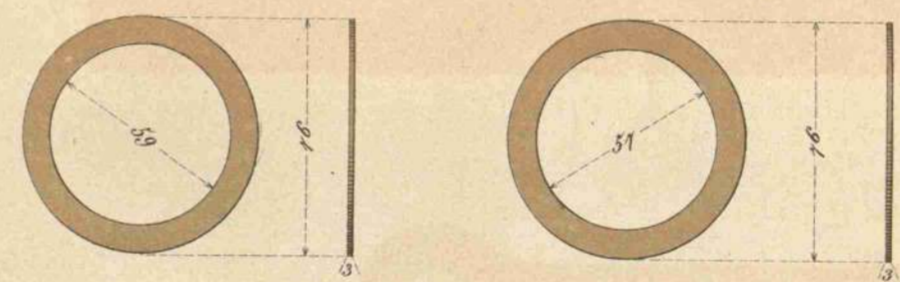

Corte por a b.

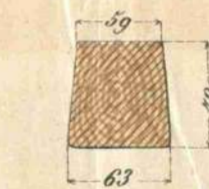

Pina (6) (1/5).

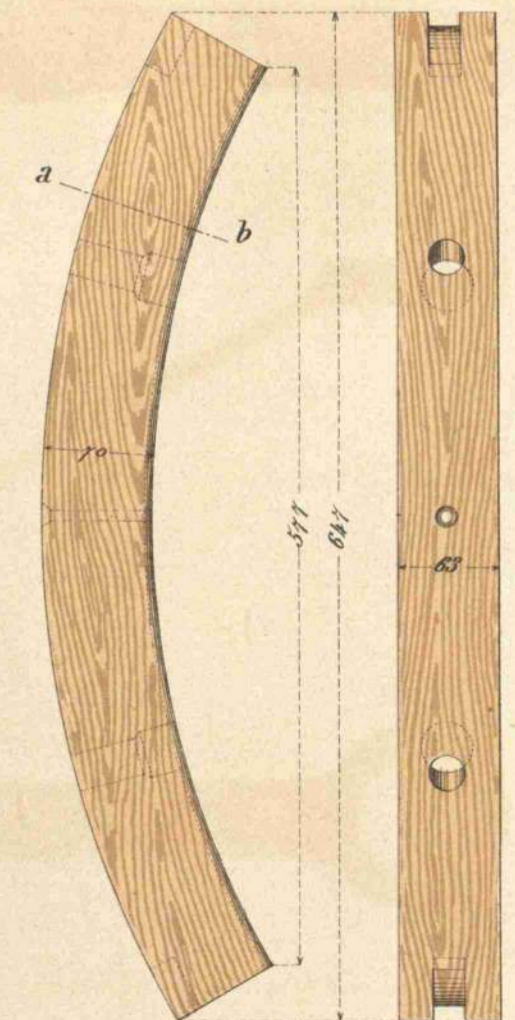

Tirante tornapuntas (2) (1/5).

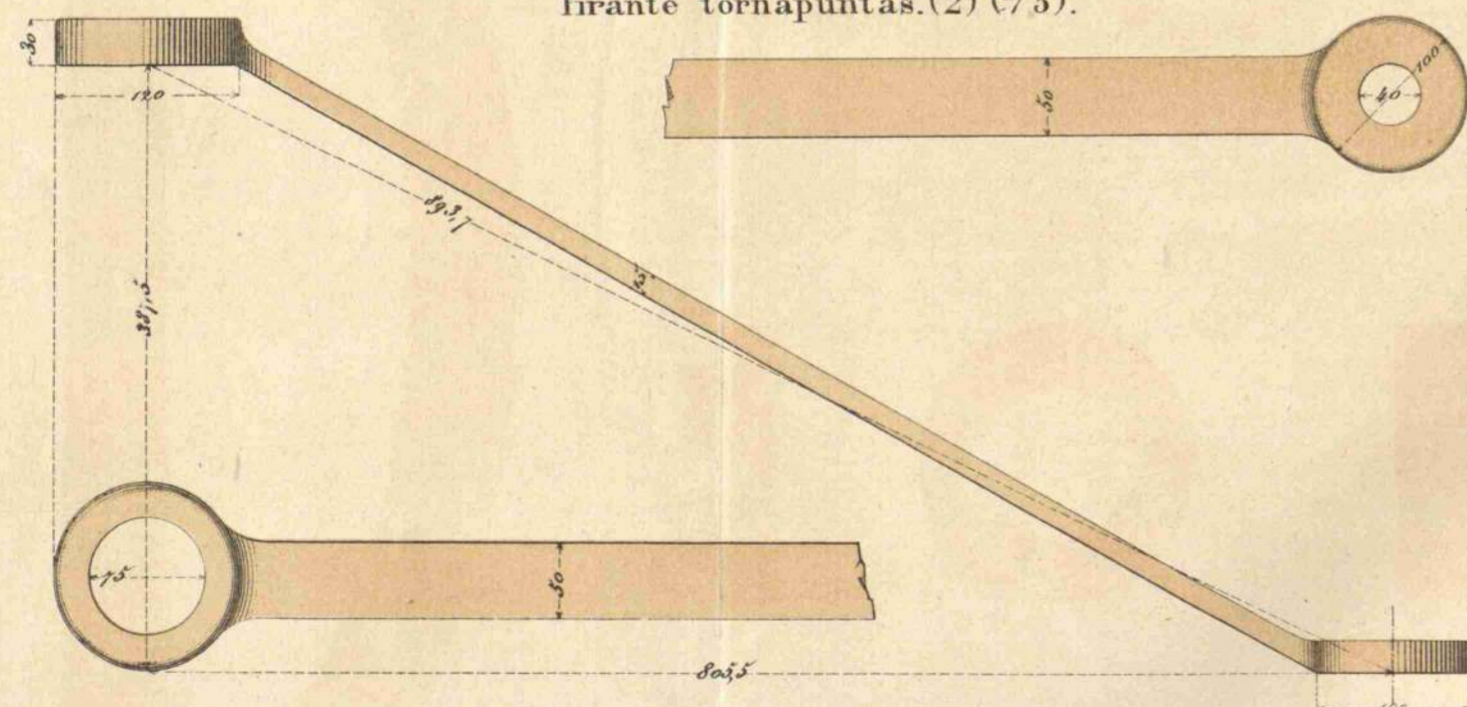

Sotrozo (2) (2/5).

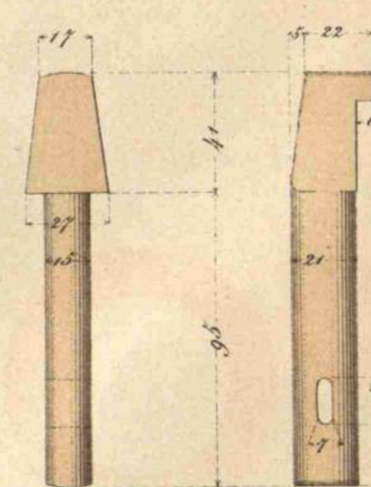

Guardapolvo interior (2) (2/5).

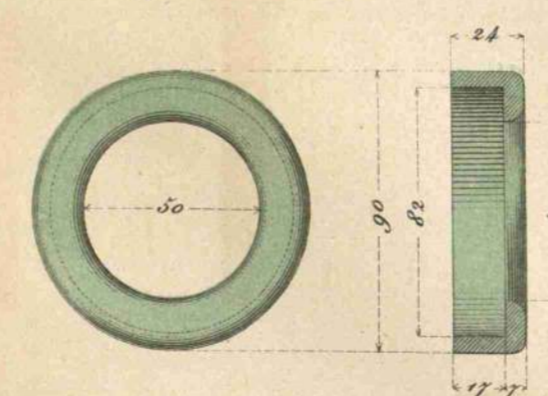

Guardapolvo exterior (2) (2/5).

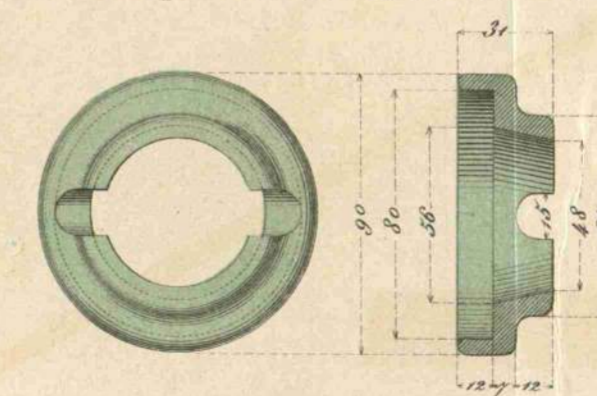

Gomas de los tirantes (2) (2/5).

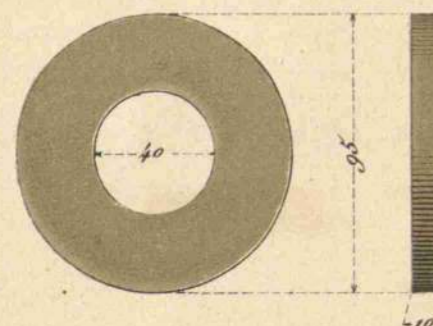

Volanderas de los tirantes (2) (2/5).

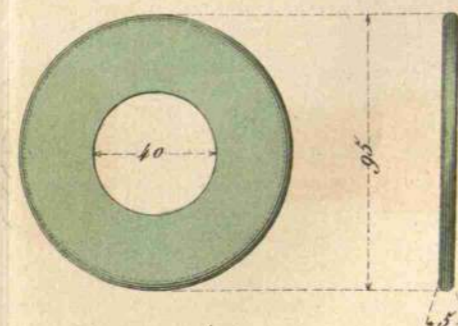

Tuerca del perno de los tirantes (2) (2/5).

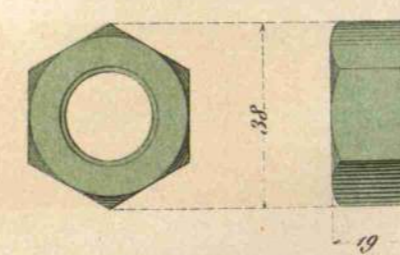

Perno de los tirantes (2/5).

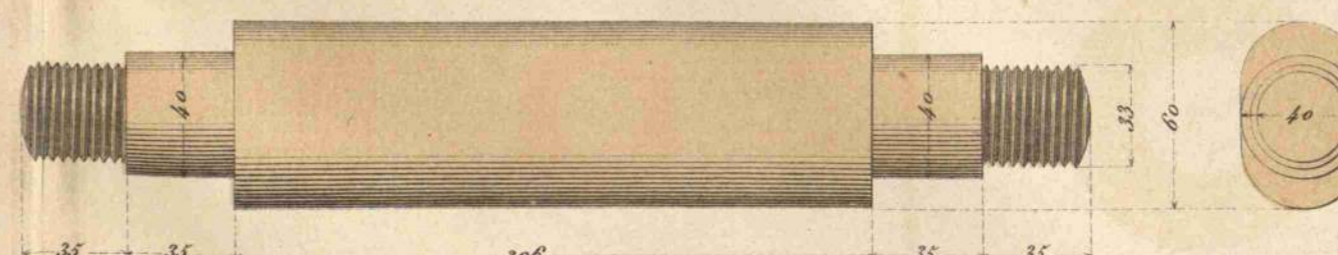

Seccion del aro (2/5).

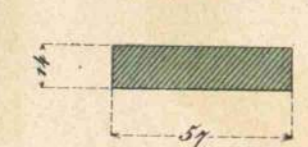











# MATERIAL DE MONTAÑA.

## REFORMA DEL HUECO PARA CARTUCHOS DE LAS CAJAS MD. 1874 Y FALDONCILLO PARA CUBRIR LA CAJA PORTACEBOS.

Caja. (1/5)

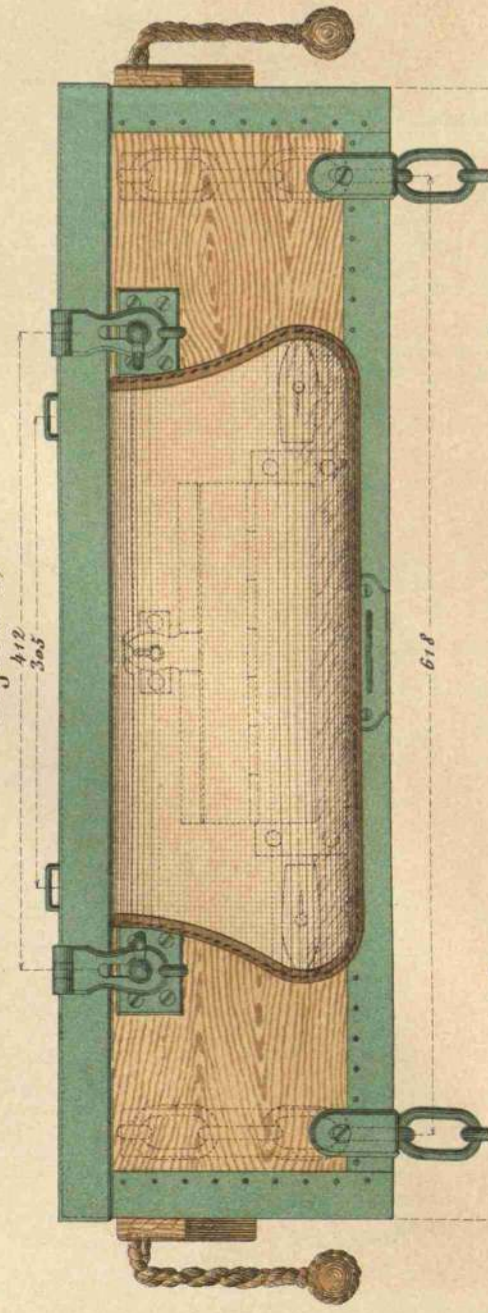

Corte por abcd

(con la tapa del hueco para cartuchos, levantada.)

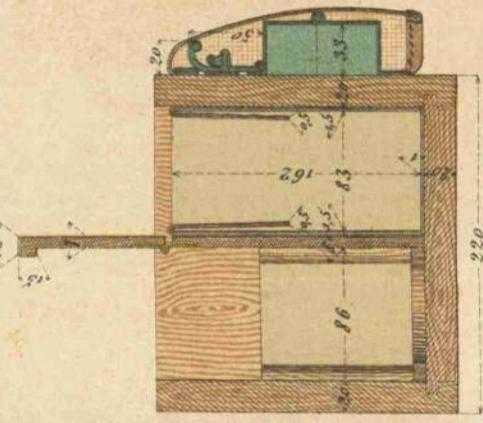

Corte por e.f.

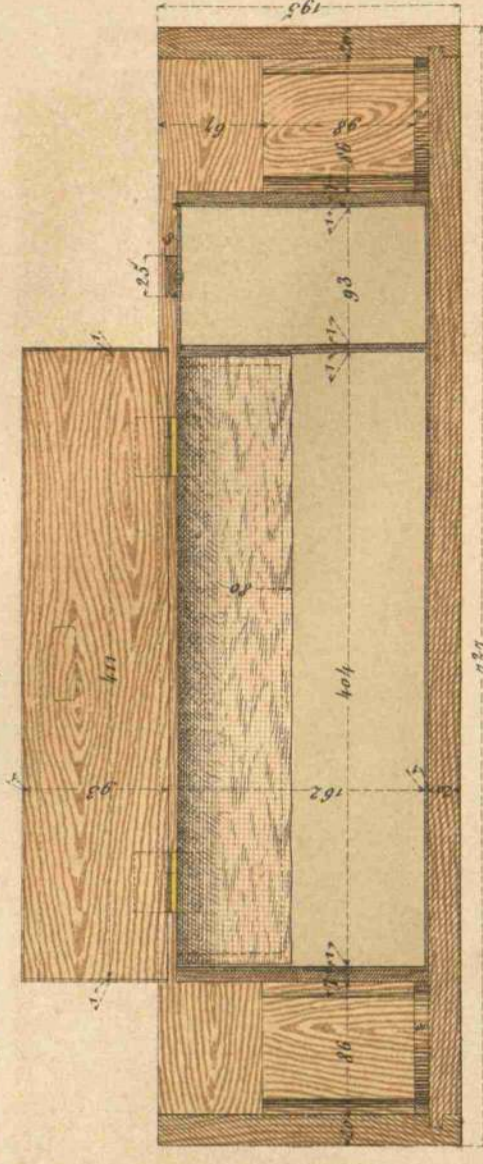

Tapa.

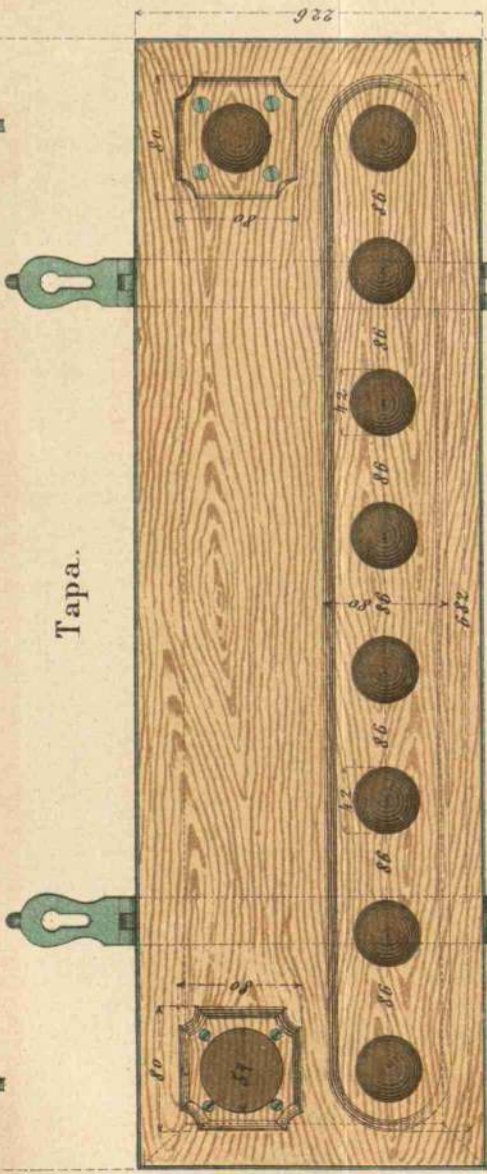

Boton para abrochar el faldoncillo. (2)(1/4).



Caja de zinc y cubiertas de lienzo (1/5)

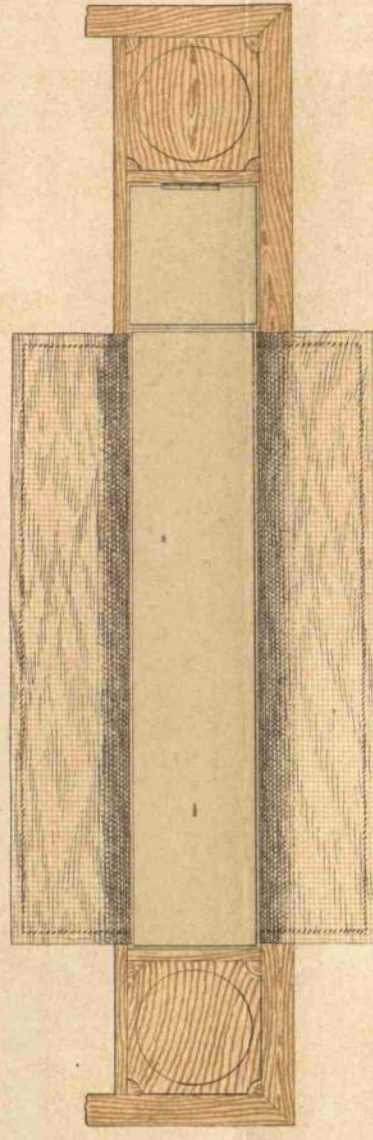

127

Caja abierta.

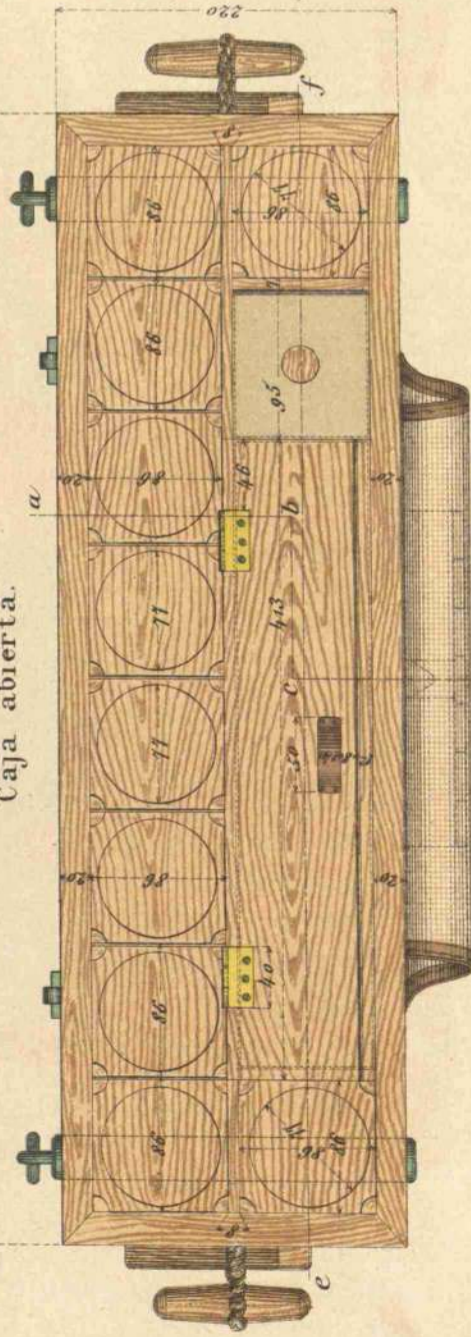

Chapa de sujecion del faldoncillo (2/5)



Faldoncillo para cubrir la caja portacebos (2/5)

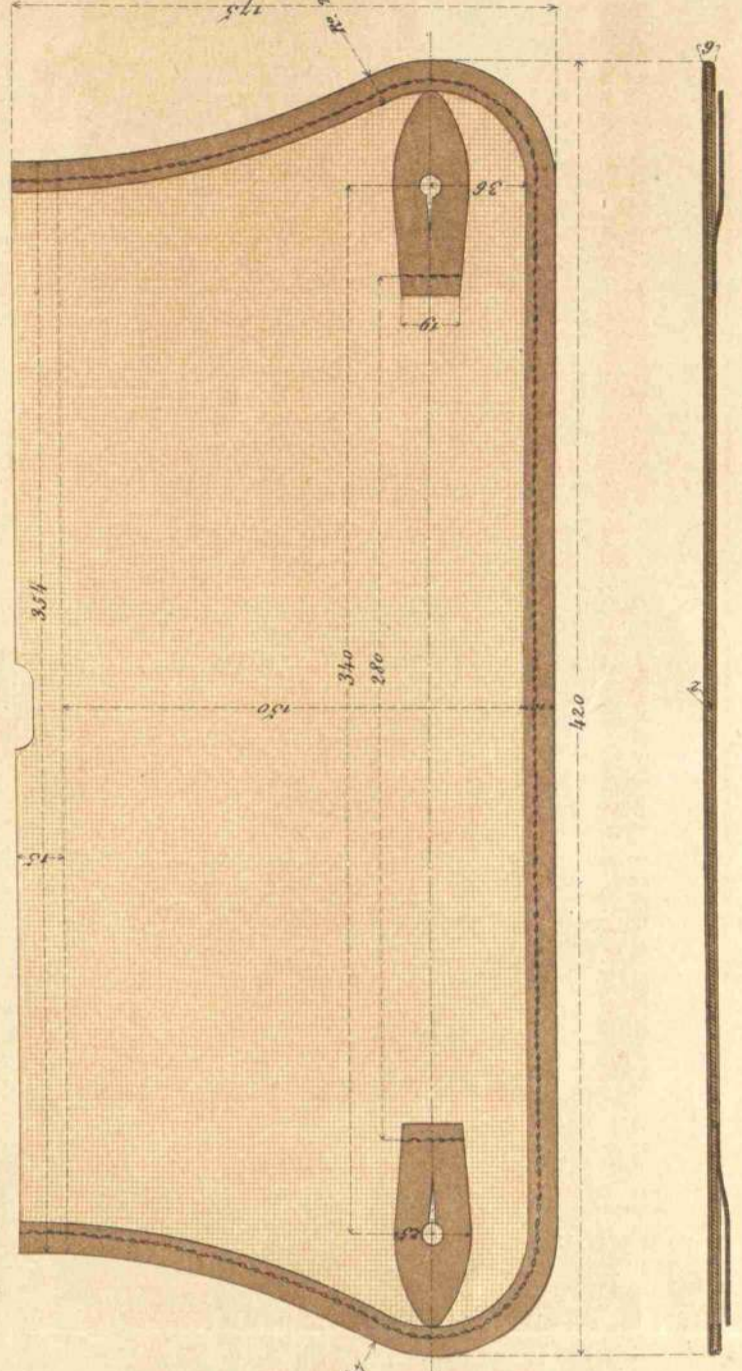



# MATERIAL DE MONTAÑA.

## REFORMA DEL HUECO PARA CARTUCHOS EN LAS CAJAS MODELO 1863 REFORMADO AL 74.

Escala 2/5.

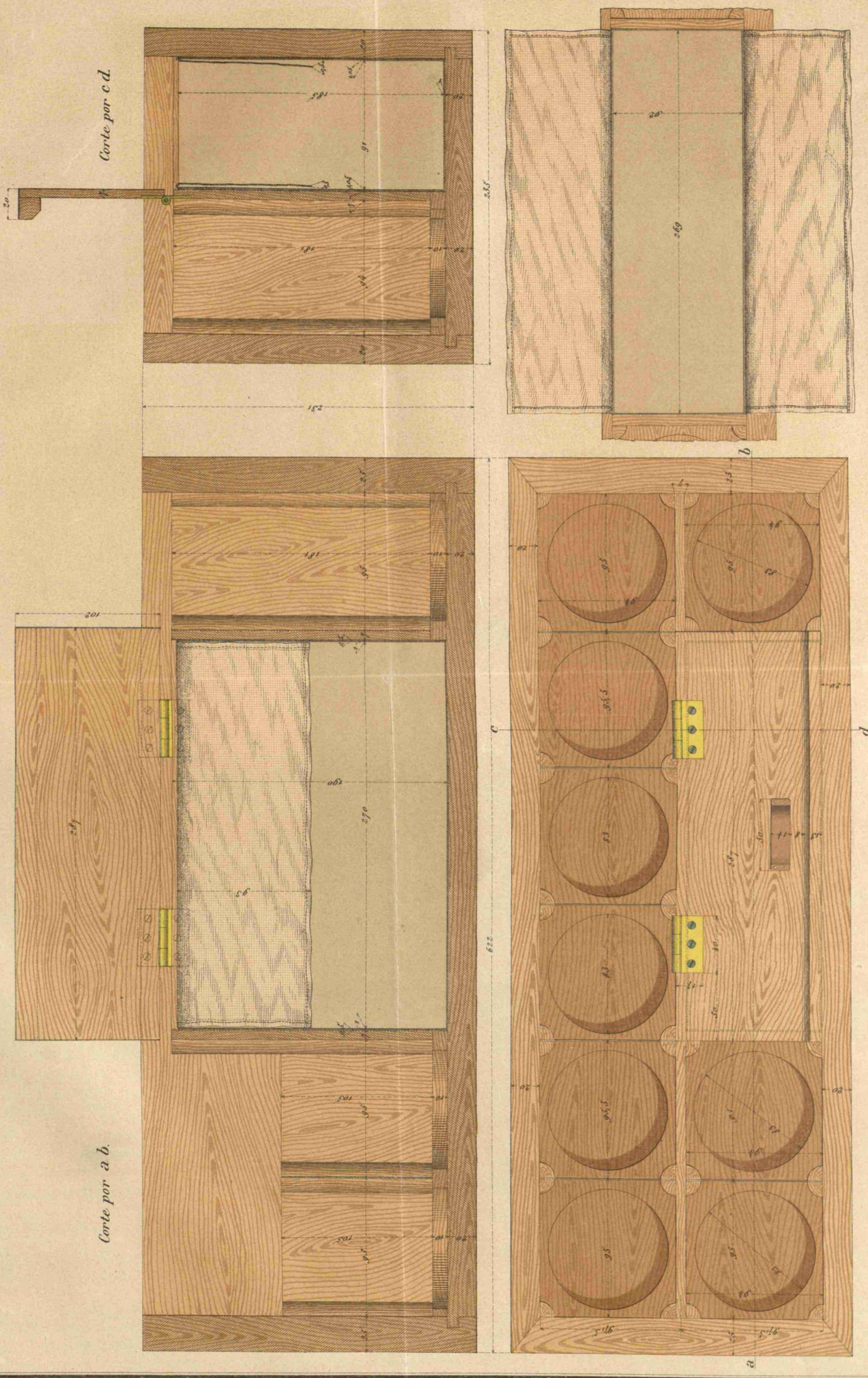



### SABLE PARA TROPA DE CABALLERIA MD. 1880.

(2/5)

Abrazaderas de fusil Md 1871  
 Forma de la guarnicion reformadas por R.O. de 8 Nov<sup>bre</sup> de 1885  
 antes de pasar á la estampa (1/4)

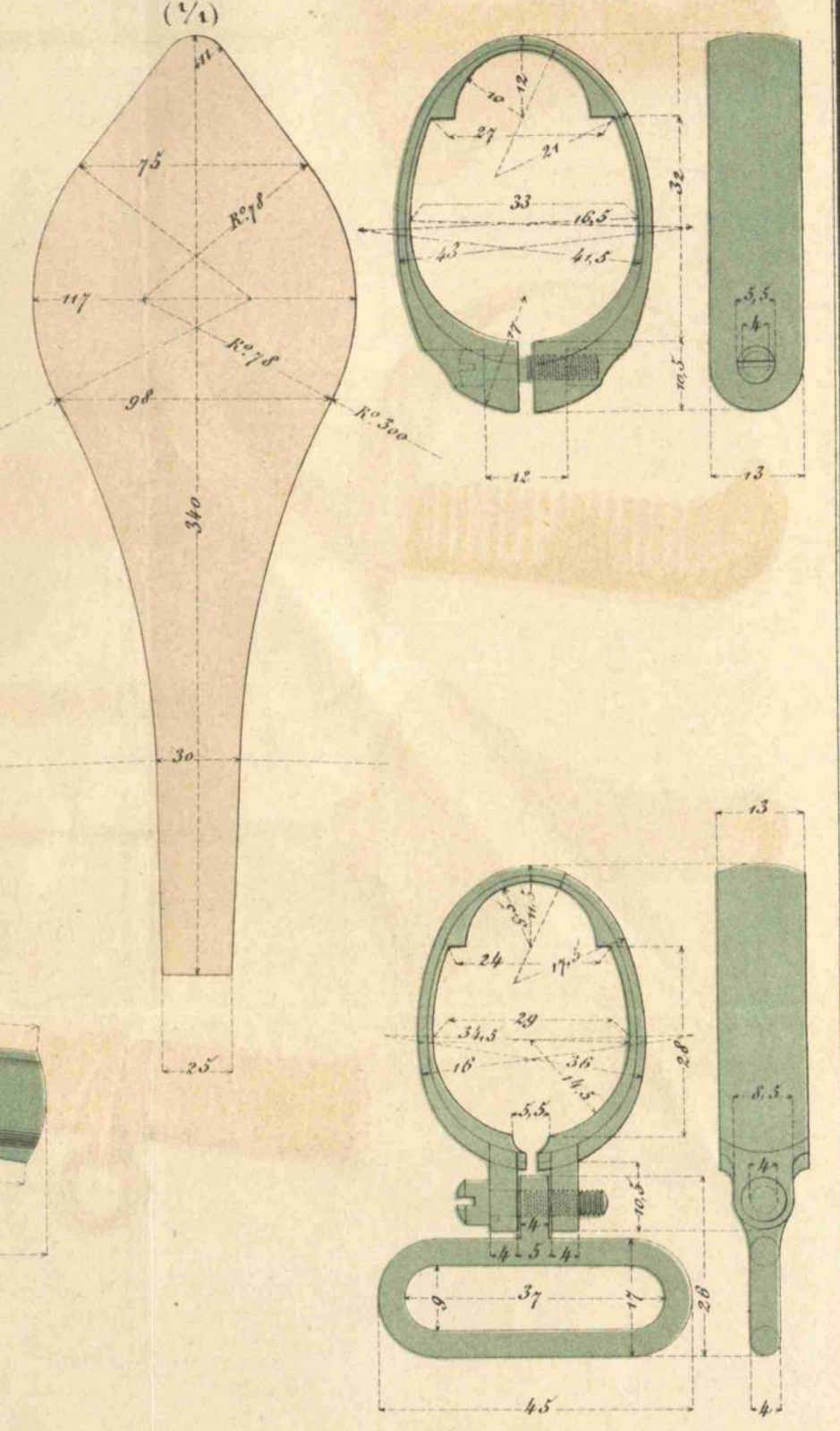
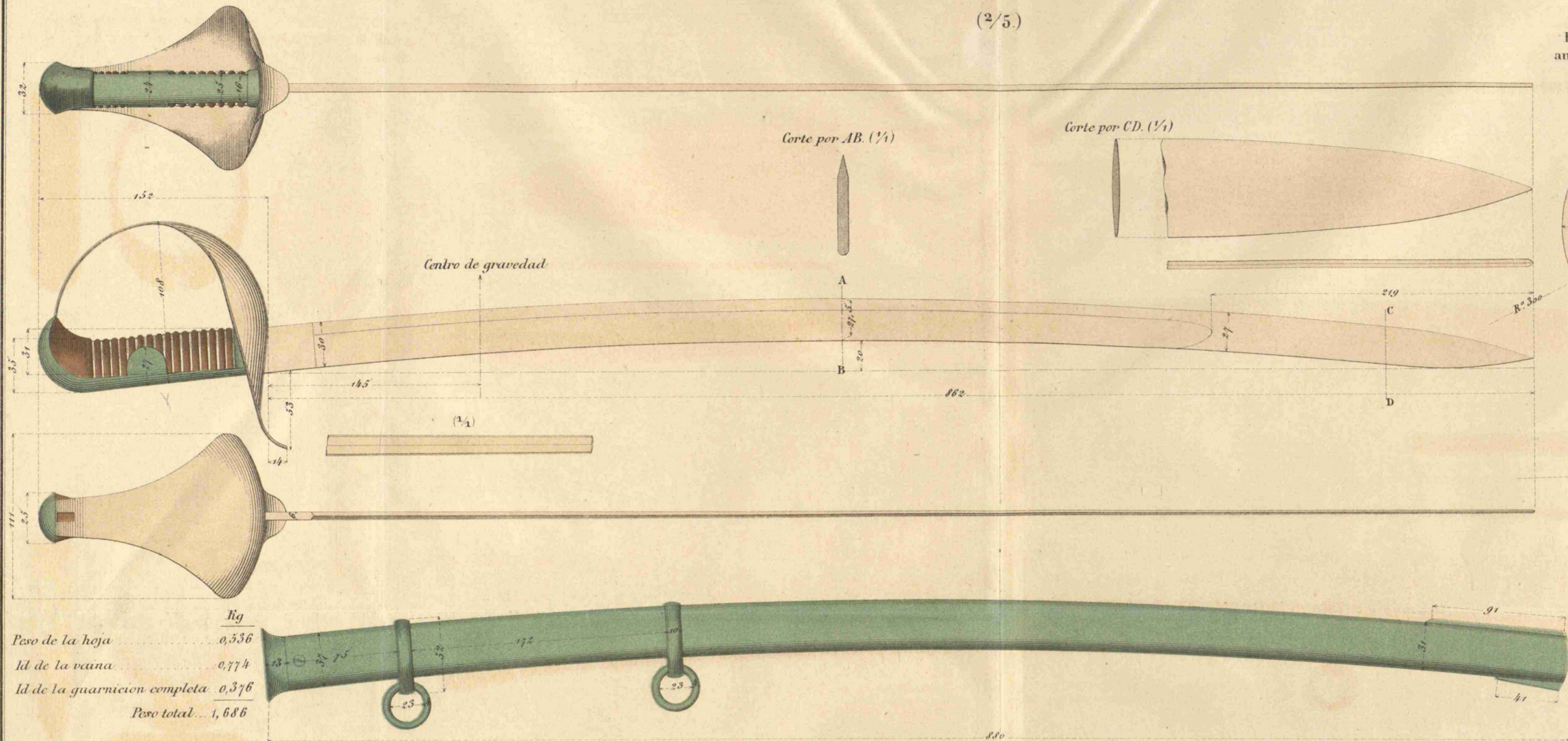

Fig

Peso de la hoja	0,536
Id de la vaina	0,774
Id de la guarnicion completa	0,376
Peso total	1,686

### MACHETE MD. 1881.

(2/5)

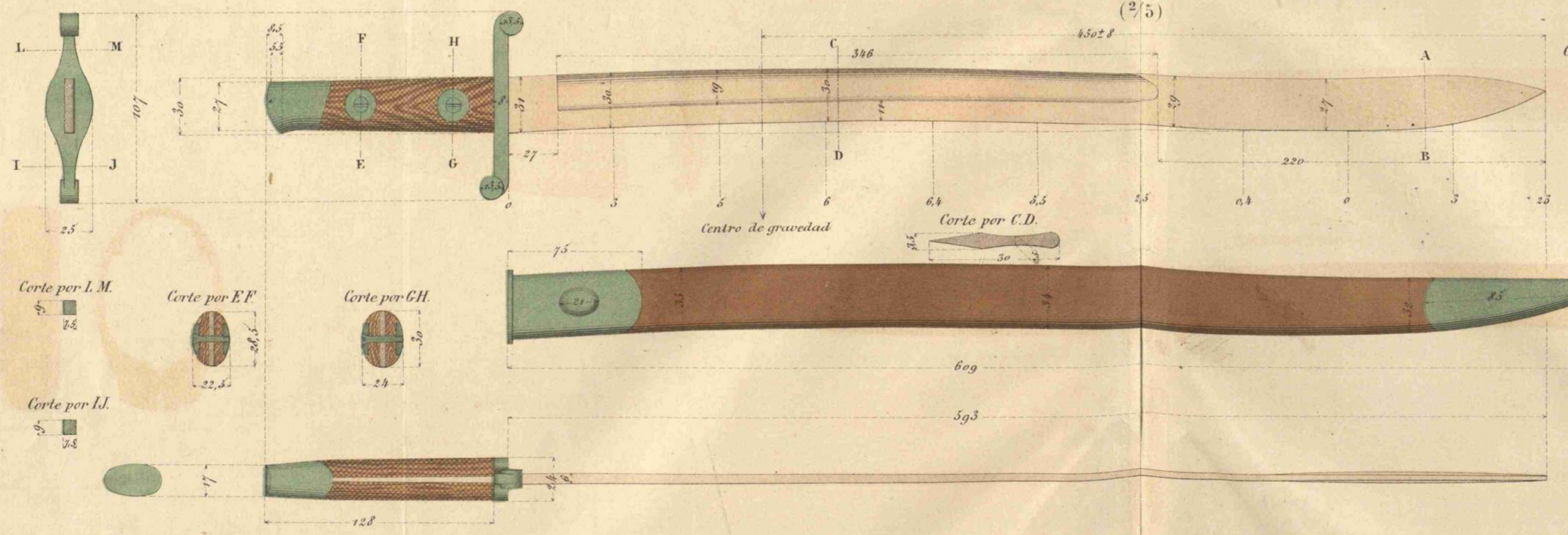

Fig

Corte por I.M.	2,5
Corte por EF	22,5
Corte por GH	2,4
Corte por JJ	2,5

Peso de la hoja	0,562
Id de la vaina	0,160
Id de la guarnicion completa	0,235
Peso total	0,957

